

AlterMundus



tkz-euclide 4.25c

tkz-euclide

Euclidean Geometry

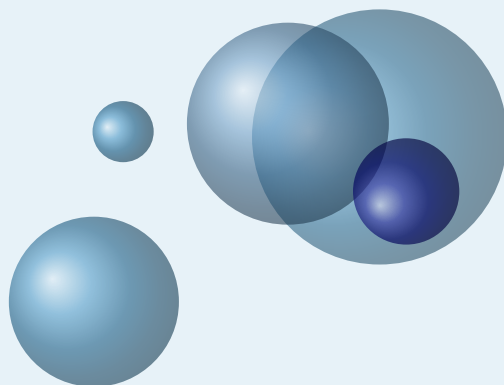

Alain Matthes

September 23, 2022 Documentation V4.25c

<http://altermundus.fr>

tkz-euclide

Alain Matthes

☞ From version 4.00, `tkz-euclide` became independent from `tkz-base`. This has implied some changes : the next major step will be the version 5 which will see the introduction of Lua. To prepare for this change, I removed the last macros that allowed to plot and define at the same time. Indeed Lua will be there to make all the calculations and define all the necessary nodes. As for TikZ, it will remain to carry out the tracings, the markings and the labels.

`tkz-euclide` is a set of convenient macros for drawing in a plane (fundamental two-dimensional object) with a Cartesian coordinate system. It handles the most classic situations in Euclidean Geometry. `tkz-euclide` is built on top of PGF and its associated front-end TikZ and is a (La)TeX-friendly drawing package. The aim is to provide a high-level user interface to build graphics relatively simply. The idea is to allow you to follow step by step a construction that would be done by hand as naturally as possible.

English is not my native language so there might be some errors.

☞ Firstly, I would like to thank **Till Tantau** for the beautiful \LaTeX package, namely `TikZ`.

☞ Acknowledgements : I received much valuable advice, remarks, corrections and examples from **Jean-Côme Charpentier**, **Josselin Noirel**, **Manuel Pégourié-Gonnard**, **Franck Pastor**, **David Arnold**, **Ulrike Fischer**, **Stefan Kottwitz**, **Christian Tellechea**, **Nicolas Kisselhoff**, **David Arnold**, **Wolfgang Büchel**, **John Kitzmiller**, **Dimitri Kapetas**, **Gaétan Marris**, **Mark Wibrow**, **Yves Combe** for his work on a protractor, **Paul Gaborit**, **Laurent Van Deik** for all his corrections, remarks and questions and **Muzimuzhi Z** for the code about the option "dim".

☞ I would also like to thank Eric Weisstein, creator of MathWorld: [MathWorld](#).

☞ You can find some examples on my site: [altermundus.fr](#). under construction!

Please report typos or any other comments to this documentation to: [Alain Matthes](#).

This file can be redistributed and/or modified under the terms of the \LaTeX Project Public License Distributed from [CTAN](#) archives.

Contents

I.	General survey : a brief but comprehensive review	14
0.1.	With 4.2 version	15
0.2.	Changes with previous versions	17
1.	Installation	18
2.	Presentation and Overview	19
2.1.	Why tkz-euclide ?	19
2.2.	TikZ vs tkz-euclide	19
2.2.1.	Book I, proposition I <code>_Euclid's Elements_</code>	19
2.2.2.	Complete code with <code>tkz-euclide</code>	20
2.2.3.	Book I, Proposition II <code>_Euclid's Elements_</code>	21
2.3.	tkz-euclide4 vs tkz-euclide3	23
2.4.	How to use the tkz-euclide package?	23
2.4.1.	Let's look at a classic example	23
2.4.2.	Part I: golden triangle	25
2.4.3.	Part II: two others methods with golden and euclid triangle	26
2.4.4.	Complete but minimal example	27
3.	The Elements of tkz code	29
3.1.	Objects and language	29
3.2.	Notations and conventions	30
3.3.	Set, Calculate, Draw, Mark, Label	31
4.	About this documentation and the examples	32
II.	Setting	33
5.	First step: fixed points	34
6.	Definition of a point : <code>\tkzDefPoint</code> or <code>\tkzDefPoints</code>	34
6.1.	Defining a named point <code>\tkzDefPoint</code>	35
6.1.1.	Cartesian coordinates	35
6.1.2.	Calculations with <code>xfp</code>	36
6.1.3.	Polar coordinates	36
6.1.4.	Relative points	36
6.2.	Point relative to another: <code>\tkzDefShiftPoint</code>	36
6.2.1.	Isosceles triangle	37
6.2.2.	Equilateral triangle	37
6.2.3.	Parallelogram	37
6.3.	Definition of multiple points: <code>\tkzDefPoints</code>	38
6.4.	Create a triangle	38
6.5.	Create a square	38
III.	Calculating	39
7.	Auxiliary tools	40
7.1.	Constants	40
7.2.	New point by calculation	40

8.	Special points	41
8.1.	Middle of a segment <code>\tkzDefMidPoint</code>	41
8.1.1.	Use of <code>\tkzDefMidPoint</code>	41
8.2.	Golden ratio <code>\tkzDefGoldenRatio</code>	41
8.2.1.	Use the golden ratio to divide a line segment	42
8.2.2.	Golden arbelos	42
8.3.	Barycentric coordinates with <code>\tkzDefBarycentricPoint</code>	42
8.3.1.	with two points	43
8.3.2.	with three points	43
8.4.	Internal and external Similitude Center	43
8.4.1.	Internal and external with <code>node</code>	44
8.4.2.	D'Alembert Theorem	44
8.4.3.	Example with <code>node</code>	45
8.5.	Harmonic division with <code>\tkzDefHarmonic</code>	46
8.5.1.	options <code>ext</code> and <code>int</code>	46
8.5.2.	Bisector and harmonic division	46
8.5.3.	option <code>both</code>	47
8.6.	Equidistant points with <code>\tkzDefEquiPoints</code>	47
8.6.1.	Using <code>\tkzDefEquiPoints</code> with options	47
8.7.	Middle of an arc	47
9.	Point on line or circle	49
9.1.	Point on a line with <code>\tkzDefPointOnLine</code>	49
9.1.1.	Use of option <code>pos</code>	50
9.2.	Point on a circle with <code>\tkzDefPointOnCircle</code>	50
9.2.1.	Altshiller's Theorem	50
9.2.2.	Use of <code>\tkzDefPointOnCircle</code>	51
10.	Special points relating to a triangle	52
10.1.	Triangle center: <code>\tkzDefTriangleCenter</code>	52
10.1.1.	Option <code>ortho</code> or <code>orthic</code>	52
10.1.2.	Option <code>centroid</code>	53
10.1.3.	Option <code>circum</code>	53
10.1.4.	Option <code>in</code>	53
10.1.5.	Option <code>ex</code>	53
10.1.6.	Option <code>euler</code>	54
10.1.7.	Option <code>symmedian</code>	54
10.1.8.	Option <code>spieker</code>	55
10.1.9.	Option <code>gergonne</code>	55
10.1.10.	Option <code>nagel</code>	56
10.1.11.	Option <code>mittenpunkt</code>	56
10.1.12.	Relation between <code>gergonne</code> , <code>centroid</code> and <code>mittenpunkt</code>	57
11.	Definition of points by transformation	57
11.1.	<code>\tkzDefPointBy</code>	58
11.1.1.	<code>translation</code>	58
11.1.2.	<code>reflection</code> (orthogonal symmetry)	59
11.1.3.	<code>homothety</code> and <code>projection</code>	59
11.1.4.	<code>projection</code>	60
11.1.5.	<code>symmetry</code>	60
11.1.6.	<code>rotation</code>	61
11.1.7.	<code>rotation in radian</code>	61
11.1.8.	<code>rotation with nodes</code>	61

11.1.9.	inversion	61
11.1.10.	Inversion of lines ex 1	63
11.1.11.	inversion of lines ex 2	63
11.1.12.	inversion of lines ex 3	63
11.1.13.	inversion of circle and homothety	64
11.1.14.	inversion of Triangle with respect to the Incircle	64
11.1.15.	inversion: orthogonal circle with inversion circle	64
11.1.16.	inversion negative	65
11.2.	Transformation of multiple points; <code>\tkzDefPointsBy</code>	66
11.2.1.	translation of multiple points	66
11.2.2.	symmetry of multiple points: an oval	67
12.	Defining points using a vector	67
12.1.	<code>\tkzDefPointWith</code>	67
12.1.1.	Option colinear at , simple example	68
12.1.2.	Option colinear at , complex example	68
12.1.3.	Option colinear at	69
12.1.4.	Option colinear at	69
12.1.5.	Option orthogonal	69
12.1.6.	Option orthogonal	70
12.1.7.	Option orthogonal more complicated example	70
12.1.8.	Options colinear and orthogonal	71
12.1.9.	Option orthogonal normed	71
12.1.10.	Option orthogonal normed and K=2	71
12.1.11.	Option linear	71
12.1.12.	Option linear normed	72
12.2.	<code>\tkzGetVectxy</code>	72
12.2.1.	Coordinate transfer with <code>\tkzGetVectxy</code>	72
13.	Straight lines	72
13.1.	Definition of straight lines	72
13.1.1.	With mediator	73
13.1.2.	An envelope with option mediator	73
13.1.3.	A parabola with option mediator	73
13.1.4.	With options bisector and normed	74
13.1.5.	With option parallel=through	74
13.1.6.	With option orthogonal and parallel	75
13.1.7.	With option altitude	75
13.1.8.	With option euler	75
13.1.9.	Tangent passing through a point on the circle tangent at	76
13.1.10.	Choice of contact point with tangents passing through an external point option tangent from	76
13.1.11.	Example of tangents passing through an external point	77
13.1.12.	Example of Andrew Mertz	77
13.1.13.	Drawing a tangent option tangent from	78
14.	Triangles	78
14.1.	Definition of triangles <code>\tkzDefTriangle</code>	78
14.1.1.	Option equilateral	79
14.1.2.	Option two angles	80
14.1.3.	Option school	80
14.1.4.	Option pythagore	80
14.1.5.	Option pythagore and swap	80

14.1.6.	Option golden	81
14.1.7.	Option euclid	81
14.1.8.	Option isosceles right	82
14.1.9.	Option gold	82
14.2.	Specific triangles with \tkzDefSpcTriangle	83
14.2.1.	How to name the vertices	83
14.3.	Option medial or centroid	83
14.3.1.	Option in or incentral	84
14.3.2.	Option ex or excentral	84
14.3.3.	Option intouch or contact	85
14.3.4.	Option extouch	85
14.3.5.	Option orthic	86
14.3.6.	Option feuerbach	87
14.3.7.	Option tangential	87
14.3.8.	Option euler	88
14.3.9.	Option euler and Option orthic	89
14.3.10.	Option symmedial	90
14.4.	Permutation of two points of a triangle	90
14.4.1.	Modification of the school triangle	91
15.	Definition of polygons	91
15.1.	Defining the points of a square	91
15.1.1.	Using \tkzDefSquare with two points	91
15.1.2.	Use of \tkzDefSquare to obtain an isosceles right-angled triangle	92
15.1.3.	Pythagorean Theorem and \tkzDefSquare	92
15.2.	Defining the points of a rectangle	92
15.2.1.	Example of a rectangle definition	92
15.3.	Definition of parallelogram	93
15.3.1.	Example of a parallelogram definition	93
15.4.	The golden rectangle	93
15.4.1.	Golden Rectangles	93
15.4.2.	Construction of the golden rectangle	94
15.5.	Regular polygon	94
15.5.1.	Option center	94
15.5.2.	Option side	95
16.	Circles	96
16.1.	Characteristics of a circle: \tkzDefCircle	96
16.1.1.	Example with option R	97
16.1.2.	Example with option diameter	97
16.1.3.	Circles inscribed and circumscribed for a given triangle	97
16.1.4.	Example with option ex	97
16.1.5.	Euler's circle for a given triangle with option euler	98
16.1.6.	Apollonius circles for a given segment option apollonius	99
16.1.7.	Circles exinscribed to a given triangle option ex	99
16.1.8.	Spieker circle with option spieker	99
16.2.	Projection of excenters	100
16.2.1.	Excircles	101
16.2.2.	Orthogonal from	102
16.2.3.	Orthogonal through	102
16.3.	Definition of circle by transformation; \tkzDefCircleBy	103
16.3.1.	Translation	104
16.3.2.	Reflection (orthogonal symmetry)	104

16.3.3.	Homothety	104
16.3.4.	Symmetry	105
16.3.5.	Rotation	105
16.3.6.	Inversion	105
17.	Intersections	105
17.1.	Intersection of two straight lines <code>\tkzInterLL</code>	106
17.1.1.	Example of intersection between two straight lines	106
17.2.	Intersection of a straight line and a circle <code>\tkzInterLC</code>	106
17.2.1.	test line-circle intersection	107
17.2.2.	Line-circle intersection	107
17.2.3.	Line passing through the center option <code>common</code>	107
17.2.4.	Line-circle intersection with option <code>common</code>	108
17.2.5.	Line-circle intersection order of points	108
17.2.6.	Example with <code>\foreach</code>	109
17.2.7.	Line-circle intersection with option <code>near</code>	109
17.2.8.	More complex example of a line-circle intersection	110
17.2.9.	Circle defined by a center and a measure, and special cases	110
17.2.10.	Calculation of radius	111
17.2.11.	Option "with nodes"	112
17.3.	Intersection of two circles <code>\tkzInterCC</code>	112
17.3.1.	test circle-circle intersection	113
17.3.2.	circle-circle intersection with <code>common</code> point.	113
17.3.3.	circle-circle intersection order of points.	113
17.3.4.	Construction of an equilateral triangle.	114
17.3.5.	Segment trisection	114
17.3.6.	With the option " <code>with nodes</code> "	115
17.3.7.	Mix of intersections	115
17.3.8.	Altshiller-Court's theorem	115
18.	Angles	116
18.1.	Definition and usage with <code>tkz-euclide</code>	116
18.2.	Recovering an angle <code>\tkzGetAngle</code>	117
18.3.	Angle formed by three points	117
18.3.1.	Verification of angle measurement	118
18.3.2.	Determination of the three angles of a triangle	118
18.3.3.	Angle between two circles	118
18.4.	Angle formed by a straight line with the horizontal axis <code>\tkzFindSlopeAngle</code>	119
18.4.1.	How to use <code>\tkzFindSlopeAngle</code>	119
18.4.2.	Use of <code>\tkzFindSlopeAngle</code> and <code>\tkzGetAngle</code>	119
18.4.3.	Another use of <code>\tkzFindSlopeAngle</code>	120
19.	Random point definition	120
19.1.	Obtaining random points	120
19.1.1.	Random point in a rectangle	121
19.1.2.	Random point on a segment or a line	121
19.1.3.	Random point on a circle or a disk	121
IV.	Drawing and Filling	122
20.	Drawing	123
20.1.	Draw a point or some points	123
20.1.1.	Drawing points <code>\tkzDrawPoint</code>	123

20.1.2.	Example of point drawings	123
20.1.3.	Example	124
21.	Drawing the lines	124
21.1.	Draw a straight line	124
21.1.1.	Examples with <code>add</code>	125
21.1.2.	Example with <code>\tkzDrawLines</code>	125
22.	Drawing a segment	125
22.1.	Draw a segment <code>\tkzDrawSegment</code>	125
22.1.1.	Example with point references	126
22.1.2.	Example of extending an segment with option <code>add</code>	126
22.1.3.	Adding dimensions with option <code>dim</code> new code from Muzimuzhi Z	126
22.1.4.	Adding dimensions with option <code>dim part I</code>	127
22.1.5.	Adding dimensions with option <code>dim part II</code>	128
22.2.	Drawing segments <code>\tkzDrawSegments</code>	128
22.2.1.	Place an arrow on segment	128
22.3.	Drawing line segment of a triangle	129
22.3.1.	How to draw <code>Altitude</code>	129
22.4.	Drawing a polygon	129
22.4.1.	<code>\tkzDrawPolygon</code>	129
22.4.2.	Option <code>two angles</code>	130
22.4.3.	Style of line	130
22.5.	Drawing a polygonal chain	130
22.5.1.	Polygonal chain	131
22.5.2.	The idea is to inscribe two squares in a semi-circle.	131
22.5.3.	Polygonal chain: index notation	131
23.	Draw a circle with <code>\tkzDrawCircle</code>	131
23.1.	Draw one circle	131
23.1.1.	Circles and styles, draw a circle and color the disc	132
23.2.	Drawing circles	132
23.2.1.	Circles defined by a triangle.	133
23.2.2.	Concentric circles.	133
23.2.3.	Exinscribed circles.	134
23.2.4.	Cardioid	134
23.3.	Drawing semicircle	135
23.3.1.	Use of <code>\tkzDrawSemiCircle</code>	135
23.4.	Drawing semicircles	135
23.4.1.	Use of <code>\tkzDrawSemiCircles</code> : Golden arbelos	136
24.	Drawing arcs	136
24.1.	Macro: <code>\tkzDrawArc</code>	136
24.1.1.	Option <code>towards</code>	136
24.1.2.	Option <code>towards</code>	137
24.1.3.	Option <code>rotate</code>	137
24.1.4.	Option <code>R</code>	137
24.1.5.	Option <code>R with nodes</code>	138
24.1.6.	Option <code>delta</code>	138
24.1.7.	Option <code>angles</code> : example 1	138
24.1.8.	Option <code>angles</code> : example 2	139
24.1.9.	Option <code>reverse</code> : inversion of the arrow	139

25.	Drawing a sector or sectors	139
25.1.	<code>\tkzDrawSector</code>	139
25.1.1.	<code>\tkzDrawSector</code> and <code>towards</code>	140
25.1.2.	<code>\tkzDrawSector</code> and <code>rotate</code>	140
25.1.3.	<code>\tkzDrawSector</code> and <code>R</code>	140
25.1.4.	<code>\tkzDrawSector</code> and <code>R</code> with nodes	140
25.1.5.	<code>\tkzDrawSector</code> and <code>R</code> with nodes	141
25.2.	Coloring a disc	141
25.2.1.	Yin and Yang	142
25.2.2.	From a sangaku	142
25.2.3.	Clipping and filling part I	143
25.2.4.	Clipping and filling part II	143
25.2.5.	Clipping and filling part III	144
25.3.	Coloring a polygon	144
25.3.1.	<code>\tkzFillPolygon</code>	144
25.4.	<code>\tkzFillSector</code>	144
25.4.1.	<code>\tkzFillSector</code> and <code>towards</code>	145
25.4.2.	<code>\tkzFillSector</code> and <code>rotate</code>	145
25.5.	Colour an angle: <code>\tkzFillAngle</code>	145
25.5.1.	Example with <code>size</code>	146
25.5.2.	Changing the order of items	146
25.5.3.	Multiples angles	147
26.	Controlling Bounding Box	147
26.1.	Utility of <code>\tkzInit</code>	147
26.2.	<code>\tkzInit</code>	148
26.3.	<code>\tkzClip</code>	148
26.4.	<code>\tkzClip</code> and the option <code>space</code>	148
26.5.	<code>tkzShowBB</code>	149
26.5.1.	Example with <code>\tkzShowBB</code>	149
26.6.	<code>tkzClipBB</code>	149
26.6.1.	Example with <code>\tkzClipBB</code> and the bisectors	150
27.	Clipping different objects	151
27.1.	Clipping a polygon	151
27.1.1.	<code>\tkzClipPolygon</code>	151
27.1.2.	<code>\tkzClipPolygon[out]</code>	151
27.1.3.	Example: use of "Clip" for Sangaku in a square	152
27.2.	Clipping a disc	152
27.2.1.	Simple clip	152
27.3.	Clip out	153
27.4.	Intersection of disks	153
27.5.	Clipping a sector	153
27.5.1.	Example 1	154
27.5.2.	Example 2	154
27.6.	Options from TikZ: trim left or right	154
27.7.	TikZ Controls <code>\pgfinterruptboundingbox</code> and <code>\endpgfinterruptboundingbox</code>	154
27.7.1.	Example about controlling the bounding box	155
27.8.	Reverse clip: <code>tkzreverseclip</code>	155
27.8.1.	Example with <code>\tkzClipPolygon[out]</code>	155

V.	Marking	157
27.9.	Mark a segment <code>\tkzMarkSegment</code>	158
27.9.1.	Several marks	158
27.9.2.	Use of <code>mark</code>	158
27.10.	Marking segments <code>\tkzMarkSegments</code>	158
27.10.1.	Marks for an isosceles triangle	158
27.11.	Another marking	159
27.12.	Mark an arc <code>\tkzMarkArc</code>	159
27.12.1.	Several marks	159
27.13.	Mark an angle mark : <code>\tkzMarkAngle</code>	159
27.13.1.	Example with <code>mark = x</code> and with <code>mark =</code>	160
27.14.	Marking a right angle: <code>\tkzMarkRightAngle</code>	160
27.14.1.	Example of marking a right angle	161
27.14.2.	Example of marking a right angle, german style	161
27.14.3.	Mix of styles	161
27.14.4.	Full example	162
27.15.	<code>\tkzMarkRightAngles</code>	162
27.16.	Angles Library	162
27.16.1.	Angle with TikZ	163
VI.	Labelling	164
28.	Labelling	165
28.1.	Label for a point	165
28.1.1.	Example with <code>\tkzLabelPoint</code>	165
28.1.2.	Label and reference	165
28.2.	Add labels to points <code>\tkzLabelPoints</code>	165
28.2.1.	Example with <code>\tkzLabelPoints</code>	166
28.3.	Automatic position of labels <code>\tkzAutoLabelPoints</code>	166
28.3.1.	Label for points with <code>\tkzAutoLabelPoints</code>	166
29.	Label for a segment	166
29.0.1.	First example	167
29.0.2.	Example : blackboard	167
29.0.3.	Labels and option : <code>swap</code>	167
29.0.4.	Labels for an isosceles triangle	168
30.	Add labels on a straight line <code>\tkzLabelLine</code>	168
30.0.1.	Example with <code>\tkzLabelLine</code>	168
30.1.	Label at an angle : <code>\tkzLabelAngle</code>	168
30.1.1.	Example author js bibra stackexchange	169
30.1.2.	With <code>pos</code>	169
30.1.3.	<code>pos</code> and <code>\tkzLabelAngles</code>	170
30.2.	Giving a label to a circle	170
30.2.1.	Example	171
31.	Label for an arc	171
31.0.1.	Label on arc	171

VII. Complements	172
32. Using the compass	173
32.1. Main macro <code>\tkzCompass</code>	173
32.1.1. Option <code>length</code>	173
32.1.2. Option <code>delta</code>	173
32.2. Multiple constructions <code>\tkzCompass</code>	173
32.2.1. Use <code>\tkzCompass</code>	174
33. The Show	174
33.1. Show the constructions of some lines <code>\tkzShowLine</code>	174
33.1.1. Example of <code>\tkzShowLine</code> and <code>parallel</code>	174
33.1.2. Example of <code>\tkzShowLine</code> and <code>perpendicular</code>	175
33.1.3. Example of <code>\tkzShowLine</code> and <code>bisector</code>	175
33.1.4. Example of <code>\tkzShowLine</code> and <code>mediator</code>	175
33.2. Constructions of certain transformations <code>\tkzShowTransformation</code>	175
33.2.1. Example of the use of <code>\tkzShowTransformation</code>	176
33.2.2. Another example of the use of <code>\tkzShowTransformation</code>	176
34. Protractor	177
34.1. The macro <code>\tkzProtractor</code>	177
34.1.1. The circular protractor	177
34.1.2. The circular protractor, transparent and returned	178
35. Miscellaneous tools and mathematical tools	178
35.1. Duplicate a segment	178
35.1.1. Use of <code>\tkzDuplicateSegment</code>	178
35.1.2. Proportion of gold with <code>\tkzDuplicateSegment</code>	179
35.1.3. Golden triangle or sublime triangle	179
35.2. Segment length <code>\tkzCalcLength</code>	179
35.2.1. Compass square construction	180
35.2.2. Example	180
35.3. Transformation from pt to cm or cm to pt	180
35.4. Change of unit	181
35.5. Get point coordinates	181
35.5.1. Coordinate transfer with <code>\tkzGetPointCoord</code>	181
35.5.2. Sum of vectors with <code>\tkzGetPointCoord</code>	181
35.6. Swap labels of points	182
35.6.1. Use of <code>\tkzSwapPoints</code>	182
35.7. Dot Product	182
35.7.1. Simple example	183
35.7.2. Cocyclic points	183
35.8. Power of a point with respect to a circle	184
35.8.1. Power from the radical axis	184
35.9. Radical axis	184
35.9.1. Two circles disjointed	185
35.10. Two intersecting circles	185
35.11. Two externally tangent circles	185
35.12. Two circles tangent internally	186
35.12.1. Three circles	186
35.13. <code>\tkzIsLinear</code> , <code>\tkzIsOrtho</code>	186
35.13.1. Use of <code>\tkzIsOrtho</code> and <code>\tkzIsLinear</code>	187

VIII. Working with style	188
36. Predefined styles	189
37. Points style	189
37.1. Use of <code>\tkzSetUpPoint</code>	189
37.1.1. Global style or local style	190
37.1.2. Local style	190
37.1.3. Style and scope	190
37.1.4. Simple example with <code>\tkzSetUpPoint</code>	190
37.1.5. Use of <code>\tkzSetUpPoint</code> inside a group	191
38. Lines style	191
38.1. Use of <code>\tkzSetUpLine</code>	191
38.1.1. Change line width	192
38.1.2. Change style of line	192
38.1.3. Example 3: extend lines	193
39. Arc style	193
39.1. The macro <code>\tkzSetUpArc</code>	193
39.1.1. Use of <code>\tkzSetUpArc</code>	193
40. Compass style, configuration macro <code>\tkzSetUpCompass</code>	194
40.1. The macro <code>\tkzSetUpCompass</code>	194
40.1.1. Use of <code>\tkzSetUpCompass</code>	194
40.1.2. Use of <code>\tkzSetUpCompass</code> with <code>\tkzShowLine</code>	194
41. Label style	194
41.1. The macro <code>\tkzSetUpLabel</code>	194
41.1.1. Use of <code>\tkzSetUpLabel</code>	195
42. Own style	195
42.1. The macro <code>\tkzSetUpStyle</code>	195
42.1.1. Use of <code>\tkzSetUpStyle</code>	195
43. How to use arrows	195
43.1. Arrows at endpoints on segment, ray or line	196
43.1.1. Scaling an arrow head	197
43.1.2. Using vector style	197
43.2. Arrows on middle point of a line segment	197
43.2.1. In a parallelogram	197
43.2.2. A line parallel to another one	198
43.2.3. Arrow on a circle	198
43.3. Arrows on all segments of a polygon	198
43.3.1. Arrow on each segment with tkz arrows	198
43.3.2. Using tkz arrows with a circle	199
IX. Examples	200
44. Different authors	201
44.1. Code from Andrew Swan	201
44.2. Example: Dimitris Kapeta	201
44.3. Example : John Kitzmiller	202
44.4. Example 1: from Indonesia	203

44.5.	Example 2: from Indonesia	204
44.6.	Illustration of the Morley theorem by Nicolas François	206
44.7.	Gou gu theorem / Pythagorean Theorem by Zhao Shuang	207
44.8.	Reuleaux-Triangle	208
45.	Some interesting examples	209
45.1.	Square root of the integers	209
45.2.	About right triangle	210
45.3.	Archimedes	210
45.3.1.	Square and rectangle of same area; Golden section	212
45.3.2.	Steiner Line and Simson Line	213
45.4.	Lune of Hippocrates	214
45.5.	Lunes of Hasan Ibn al-Haytham	214
45.6.	About clipping circles	216
45.7.	Similar isosceles triangles	217
45.8.	Revised version of "Tangente"	218
45.9.	"Le Monde" version	219
45.10.	Triangle altitudes	220
45.11.	Altitudes - other construction	221
45.12.	Three circles in an Equilateral Triangle	222
45.13.	Law of sines	223
45.14.	Flower of Life	224
45.15.	Pentagon in a circle	226
45.16.	Pentagon in a square	227
45.17.	Hexagon Inscribed	228
45.17.1.	Hexagon Inscribed version 1	228
45.17.2.	Hexagon Inscribed version 2	228
45.18.	Power of a point with respect to a circle	229
45.19.	Radical axis of two non-concentric circles	230
45.20.	External homothetic center	231
45.21.	Tangent lines to two circles	232
45.22.	Tangent lines to two circles with radical axis	233
45.23.	Middle of a segment with a compass	235
45.24.	Definition of a circle _Apollonius_	236
45.25.	Application of Inversion : Pappus chain	237
45.26.	Book of lemmas proposition 1 Archimedes	238
45.27.	Book of lemmas proposition 6 Archimedes	238
45.28.	"The" Circle of APOLLONIUS	241
X.	FAQ	244
46.	FAQ	245
46.1.	Most common errors	245
	Index	246

Part I.

General survey : a brief but comprehensive review

News and compatibility

0.1. With 4.2 version

Some changes have been made to make the syntax more homogeneous and especially to distinguish the definition and search for coordinates from the rest, i.e. drawing, marking and labelling. Now the definition macros are isolated, it will be easier to introduce a phase of coordinate calculations using **Lua**.

Here are some of the changes.

- I recently discovered a problem when using the "scale" option. When plotting certain figures with certain tools, extensive use of `pgfmathreciprocal` involves small computational errors but can add up and render the figures unfit. Here is how to proceed to avoid these problems:
 1. On my side I introduced a patch proposed by Muzimuzhi that modifies `pgfmathreciprocal`;
 2. Another idea proposed by Muzimuzhi is to pass as an option for the `tikzpicture` environment this `/pgf/fpu/install only={reciprocal}` after loading of course the `fpu` library;
 3. I have in the methods chosen to define my macros tried to avoid as much as possible the use of `pgfmathreciprocal`;
 4. There is still a foolproof method which consists in avoiding the use of `scale = ...`. It's quite easy if, like me, you only work with fixed points fixed at the beginning of your code. The size of your figure depends only on these fixed points so you just have to adapt the coordinates of these.
- Now `\tkzDefCircle` gives two points as results: the center of the circle and a point of the circle. When a point of the circle is known, it is enough to use `\tkzGetPoint` or `\tkzGetFirstPoint` to get the center, otherwise `\tkzGetPoints` will give you the center and a point of the circle. You can always get the length of the radius with `\tkzGetLength`. I wanted to favor working with nodes and banish the appearance of numbers in the code.
- In order to isolate the definitions, I deleted or modified certain macros which are: `\tkzDrawLine`, `\tkzDrawTriangle`, `\tkzDrawCircle`, `\tkzDrawSemiCircle` and `\tkzDrawRectangle`;
 Thus `\tkzDrawSquare(A,B)` becomes `\tkzDefSquare(A,B)\tkzGetPoints{C}{D}` then `\tkzDrawPolygon(A,B,C,D)`;
 If you want to draw a circle, you can't do so `\tkzDrawCircle[R](A,1)`. First you have to define the point through which the circle passes, so you have to do `\tkzDefCircle[R](A,1)\tkzGetPoint{a}` and finally `\tkzDrawCircle(A,a)`. Another possibility is to define a point on the circle `\tkzDefShiftPoint[A](1,0){a}`;
- The following macros `\tkzDefCircleBy[orthogonal through]` and `\tkzDefCircleBy[orthogonal from]` become `\tkzDefCircle[orthogonal through]` and `\tkzDefCircle[orthogonal from]`;
- `\tkzDefLine[euler](A,B,C)` is a macro that allows you to obtain the line of Euler when possible. `\tkzDefLine[altitude]` is possible again, as well as `\tkzDefLine[tangent at=A](O)` and `\tkzDefLine[tangent from=P](O,A)` which did not work;
- `\tkzDefTangent` is replaced by `\tkzDelLine[tangent from = ...]` or `\tkzDelLine[tangent at = ...]`;
- I added the macro `\tkzPicAngle[tikz options](A,B,C)` for those who prefer to use TikZ;
- The macro `\tkzMarkAngle` has been corrected;
- The macro linked to the `apollonius` option of the `\tkzDefCircle` command has been rewritten;

- (4.23) The macro `\tkzDrawSemiCircle` has been corrected;
- The order of the arguments of the macro `\tkzDefPointOnCircle` has changed: now it is center, angle and point or radius. I have added two options for working with radians which are `through in rad` and `R in rad`.
- I added the option `reverse` to the arcs paths. This allows to reverse the path and to reverse if necessary the arrows that would be present.
- I have unified the styles for the labels. There is now only `label style` left which is valid for points, segments, lines, circles and angles. I have deleted `label seg style`, `label line style` and `label angle style`
- I added the macro `tkzFillAngles` to use several angles.
- Correction option `return` with `\tkzProtractor`
As a reminder, the following changes have been made previously:
 - `\tkzDrawMedian`, `\tkzDrawBisector`, `\tkzDrawAltitude`, `\tkzDrawMedians`, `\tkzDrawBisectors` et `\tkzDrawAltitudes` do not exist anymore. The creation and drawing separation is not respected so it is preferable to first create the coordinates of these points with `\tkzDefSpcTriangle[median]` and then to choose the ones you are going to draw with `\tkzDrawSegments` or `\tkzDrawLines`;
 - `\tkzDrawTriangle` has been deleted. `\tkzDrawTriangle[equilateral]` was handy but it is better to get the third point with `\tkzDefTriangle[equilateral]` and then draw with `\tkzDrawPolygon`; idem for `\tkzDrawSquare` and `\tkzDrawGoldRectangle`;
 - The circle inversion was badly defined so I rewrote the macro. The input arguments are always the center and a point of the circle, the output arguments are the center of the image circle and a point of the image circle or two points of the image line if the antecedent circle passes through the pole of the inversion. If the circle passes the inversion center, the image is a straight line, the validity of the procedure depends on the choice of the point on the antecedent circle;
 - Correct allocation for gold sublime and euclide triangles;
 - I added the option `" next to"` for the intersections LC and CC;
 - Correction option `isocetes right`;
 - (4.22 and 4.23) Correction of the macro `\tkzMarkAngle`;
 - `\tkzDefMidArc(O,A,B)` gives the middle of the arc center O from A to B;
 - Good news : Some useful tools have been added. They are present on an experimental basis and will undoubtedly need to be improved;
 - The options `"orthogonal from and through"` depend now of `\tkzDefCircleBy`
 1. `\tkzDotProduct(A,B,C)` computes the scalar product in an orthogonal reference system of the vectors \overrightarrow{A} , \overrightarrow{B} and $\overrightarrow{A}, \overrightarrow{C}$.
 $\text{\tkzDotProduct}(A,B,C)=aa'+bb'$ if $\text{vec}\{AB\}=(a,b)$ and $\text{vec}\{AC\}=(a',b')$

2. `\tkzPowerCircle(A)(B,C)` power of point A with respect to the circle of center B passing through C;
3. `\tkzDefRadicalAxis(A,B)(C,D)` Radical axis of two circles of center A and C;
4. (4.23) The macro `\tkzDefRadicalAxis` has been completed
5. Some tests : `\tkzIsOrtho(A,B,C)` and `\tkzIsLinear(A,B,C)` The first indicates whether the lines (A,B) and (A,C) are orthogonal. The second indicates whether the points A, B and C are aligned; `\tkzIsLinear(A,B,C)` if A,B,C are aligned then `\tkzLineartrue` you can use `\iftkzLinear` (idem for `\tkzIsOrtho`);
6. A style for vectors has been added that you can of course modify `\tikzset{vector style/.style={>=Latex,->}}`;
7. Now it's possible to add an arrow on a line or a circle with the option `tkz arrow`.

0.2. Changes with previous versions

- I remind you that an important novelty is the recent replacement of the `fp` package by `xfp`. This is to improve the calculations a little bit more and to make it easier to use;
- First of all, you don't have to deal with TikZ the size of the bounding box. Early versions of `tkz-euclide` did not control the size of the bounding box, The bounding box is now controlled in each macro (hopefully) to avoid the use of `\tkzInit` followed by `\tkzClip`;
- With `tkz-euclide` loads all objects, so there's no need to place `\usetkzobj{all}`;
- Added macros for the bounding box: `\tkzSaveBB` `\tkzClipBB` and so on;
- Logically most macros accept TikZ options. So I removed the "duplicate" options when possible thus the "label options" option is removed;
- The unit is now the cm;
- `\tkzCalcLength` `\tkzGetLength` gives result in cm;
- `\tkzMarkArc` and `\tkzLabelArc` are new macros;
- Now `\tkzClipCircle` and `\tkzClipPolygon` have an option **out**. To use this option you must have a Bounding Box that contains the object on which the Clip action will be performed. This can be done by using an object that encompasses the figure or by using the macro `\tkzInit`;
- The options `end` and `start` which allowed to give a label to a straight line are removed. You now have to use the macro `\tkzLabelLine`;
- Introduction of the libraries `quotes` and `angles`; it allows to give a label to a point, even if I am not in favour of this practice;
- The notion of vector disappears, to draw a vector just pass `"->"` as an option to `\tkzDrawSegment`;
- `\tkzDefIntSimilitudeCenter` and `\tkzDefExtSimilitudeCenter` do not exist anymore, now you need to use `\tkzDefSimilitudeCenter[int]` or `\tkzDefSimilitudeCenter[ext]`;

- `\tkzDefRandPointOn` is replaced by `\tkzGetRandPointOn`;
- An option of the macro `\tkzDefTriangle` has changed, in the previous version the option was "euclide" with an "e". Now it's "euclid";
- Random points are now in `tkz-euclide` and the macro `\tkzGetRandPointOn` is replaced by `\tkzDefRandPointOn`. For homogeneity reasons, the points must be retrieved with `\tkzGetPoint`;
- New macros have been added : `\tkzDrawSemiCircles`, `\tkzDrawPolygons`, `\tkzDrawTriangles`;
- Option "isosceles right" is a new option of the macro `\tkzDefTriangle`;
- Appearance of the macro `\usetkztool` which allows to load new "tools";
- The styles can be modified with the help of the following macros : `\tkzSetUpPoint`, `\tkzSetUpLine`, `\tkzSetUpArc`, `\tkzSetUpCompass`, `\tkzSetUpLabel` and `\tkzSetUpStyle`. The last one allows you to create a new style.

1. Installation

`tkz-euclide` is on the server of the CTAN¹. If you want to test a beta version, just put the following files in a `texmf` folder that your system can find. You will have to check several points:

- The `tkz-euclide` folder must be located on a path recognized by `latex`.
- The `tkz-euclide` uses `xfp`.
- You need to have PGF installed on your computer. `tkz-euclide` use several libraries of TikZ
 - angles,
 - arrows,
 - arrows.meta,
 - calc,
 - decorations,
 - decorations.markings,
 - decorations.pathreplacing,
 - decorations.shapes,
 - decorations.text,
 - decorations.pathmorphing,
 - intersections,
 - math,
 - plotmarks,
 - positioning,
 - quotes,
 - shapes.misc,
 - through
- This documentation and all examples were obtained with `lualatex` but `pdflatex` or `xelatex` should be suitable.

¹ `tkz-euclide` is part of TeXLive and `tlmgr` allows you to install them. This package is also part of MiKTeX under Windows.

2. Presentation and Overview

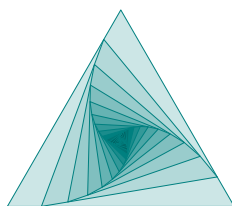

```
\begin{tikzpicture}[scale=.25]
\tkzDefPoints{0/Q/A,12/Q/B,6/12*sind(60)/C}
\foreach \density in {20,30,...,240}{%
\tkzDrawPolygon[fill=teal!\density](A,B,C)
\pgfnodealias{X}{A}
\tkzDefPointWith[linear,K=.15](A,B) \tkzGetPoint{A}
\tkzDefPointWith[linear,K=.15](B,C) \tkzGetPoint{B}
\tkzDefPointWith[linear,K=.15](C,X) \tkzGetPoint{C}}
\end{tikzpicture}
```

2.1. Why tkz-euclide?

My initial goal was to provide other mathematics teachers and myself with a tool to quickly create Euclidean geometry figures without investing too much effort in learning a new programming language. Of course, **tkz-euclide** is for math teachers who use \LaTeX and makes it possible to easily create correct drawings by means of \LaTeX .

It appeared that the simplest method was to reproduce the one used to obtain construction by hand. To describe a construction, you must, of course, define the objects but also the actions that you perform. It seemed to me that syntax close to the language of mathematicians and their students would be more easily understandable; moreover, it also seemed to me that this syntax should be close to that of \LaTeX . The objects, of course, are points, segments, lines, triangles, polygons and circles. As for actions, I considered five to be sufficient, namely: define, create, draw, mark and label.

The syntax is perhaps too verbose but it is, I believe, easily accessible. As a result, the students like teachers were able to easily access this tool.

2.2. TikZ vs tkz-euclide

I love programming with TikZ, and without TikZ I would never have had the idea to create **tkz-euclide** but never forget that behind it there is TikZ and that it is always possible to insert code from TikZ. **tkz-euclide** doesn't prevent you from using TikZ. That said, I don't think mixing syntax is a good thing.

There is no need to compare TikZ and **tkz-euclide**. The latter is not addressed to the same audience as TikZ. The first one allows you to do a lot of things, the second one only does geometry drawings. The first one can do everything the second one does, but the second one will more easily do what you want.

The main purpose is to define points to create geometrical figures. **tkz-euclide** allows you to draw the essential objects of Euclidean geometry from these points but it may be insufficient for some actions like coloring surfaces. In this case you will have to use TikZ which is always possible.

Here are some comparisons between TikZ and **tkz-euclide** 4. For this I will use the geometry examples from the *PgfManual*. The two most important Euclidean tools used by early Greeks to construct different geometrical shapes and angles were a compass and a straightedge. My idea is to allow you to follow step by step a construction that would be done by hand (with compass and straightedge) as naturally as possible.

2.2.1. Book I, proposition I Euclid's Elements

Book I, proposition I Euclid's Elements

To construct an equilateral triangle on a given finite straight line.

Explanation :

The fourth tutorial of the *PgfManual* is about geometric constructions. *T. Tantau* proposes to get the drawing with its beautiful tool TikZ. Here I propose the same construction with *tkz-elements*. The color of the TikZ code is orange and that of *tkz-elements* is red.

```

\usepackage{tikz}
\usetikzlibrary{calc,intersections,through,backgrounds}

\usepackage{tkz-euclide}

```

How to get the line AB ? To get this line, we use two fixed points.

```

\coordinate [label=left:$A$] (A) at (0,0);
\coordinate [label=right:$B$] (B) at (1.25,0.25);
\draw (A) -- (B);
\tkzDefPoint(0,0){A}
\tkzDefPoint(1.25,0.25){B}
\tkzDrawSegment(A,B)
\tkzLabelPoint[left](A){$A$}
\tkzLabelPoint[right](B){$B$}

```

We want to draw a circle around the points A and B whose radius is given by the length of the line AB.

```

\draw let \p1 = ($ (B) - (A) $),
\n2 = {veclen(\x1,\y1)} in
(A) circle (\n2)
(B) circle (\n2);

```

```

\tkzDrawCircles(A,B B,A)

```

The intersection of the circles \mathcal{D} and \mathcal{E}

```

draw [name path=A--B] (A) -- (B);
node (D) [name path=D,draw,circle through=(B),label=left:$D$] at (A) {};
node (E) [name path=E,draw,circle through=(A),label=right:$E$] at (B) {};
path [name intersections={of=D and E, by={ [label=above:$C$]C, [label=below:$C'$]C' }}];
draw [name path=C--C',red] (C) -- (C');
path [name intersections={of=A--B and C--C',by=F}];
node [fill=red,inner sep=1pt,label=-45:$F$] at (F) {};

```

```

\tkzInterCC(A,B)(B,A) \tkzGetPoints{C}{X}

```

How to draw points :

```

\foreach \point in {A,B,C}
\fill [black,opacity=.5] (\point) circle (2pt);

\tkzDrawPoints[fill=gray,opacity=.5](A,B,C)

```

2.2.2. Complete code with tkz-euclide

We need to define colors

```

\colorlet{input}{red!80!black}
\colorlet{output}{red!70!black}
\colorlet{triangle}{orange!40}

```

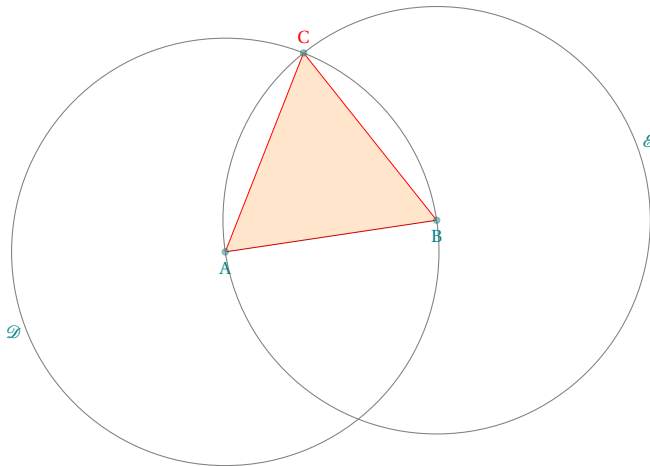

```

\colorlet{input}{red!80!black}
\colorlet{output}{red!70!black}
\colorlet{triangle}{orange!40}
\begin{tikzpicture}[scale=1.25,thick,help lines/.style={thin,draw=black!50}]
\tkzDefPoint(0,0){A}
\tkzDefPoint(1.25+rand(),0.25+rand()){B}
\tkzInterCC(A,B)(B,A) \tkzGetPoints{C}{X}

\tkzFillPolygon[triangle,opacity=.5](A,B,C)
\tkzDrawSegment[input](A,B)
\tkzDrawSegments[red](A,C B,C)
\tkzDrawCircles[help lines](A,B B,A)
\tkzDrawPoints[fill=gray,opacity=.5](A,B,C)

\tkzLabelPoints(A,B)
\tkzLabelCircle[below=12pt](A,B)(180){$\mathcal{D}$}
\tkzLabelCircle[above=12pt](B,A)(180){$\mathcal{E}$}
\tkzLabelPoint[above,red](C){$C$}

\end{tikzpicture}

```

2.2.3. Book I, Proposition II Euclid's Elements

Book I, Proposition II Euclid's Elements

To place a straight line equal to a given straight line with one end at a given point.

Explanation

In the first part, we need to find the midpoint of the straight line AB. With TikZ we can use the calc library

```

\coordinate [label=left:$A$] (A) at (0,0);
\coordinate [label=right:$B$] (B) at (1.25,0.25);
\draw (A) -- (B);
\node [fill=red,inner sep=1pt,label=below:$X$] (X) at ($(A)!.5!(B)$) {};

```

With tkz-euclide we have a macro `\tkzDefMidPoint`, we get the point X with `\tkzGetPoint` but we don't need this point to get the next step.

```

\tkzDefPoints{0/0/A,0.75/0.25/B,1/1.5/C}
\tkzDefMidPoint(A,B) \tkzGetPoint{X}

```

Then we need to construct a triangle equilateral. It's easy with `tkz-euclide`. With TikZ you need some effort because you need to use the midpoint X to get the point D with trigonometry calculation.

```
\node [fill=red,inner sep=1pt,label=below:$X$] (X) at ($ (A)!.5!(B) $) {};
\node [fill=red,inner sep=1pt,label=above:$D$] (D) at
($ (X) ! {\sin(60)*2} ! 90:(B) $) {};
\draw (A) -- (D) -- (B);
```

```
\tkzDefTriangle[equilateral](A,B) \tkzGetPoint{D}
```

We can draw the triangle at the end of the picture with

```
\tkzDrawPolygon{A,B,C}
```

We know how to draw the circle \mathcal{H} around B through C and how to place the points E and F

```
\node (H) [label=135:$H$,draw,circle through=(C)] at (B) {};
\draw (D) -- ($ (D) ! 3.5 ! (B) $) coordinate [label=below:$F$] (F);
\draw (D) -- ($ (D) ! 2.5 ! (A) $) coordinate [label=below:$E$] (E);
```

```
\tkzDrawCircle(B,C)
\tkzDrawLines[add=0 and 2](D,A D,B)
```

We can place the points E and F at the end of the picture. We don't need them now.

Intersecting a Line and a Circle : here we search the intersection of the circle around B through C and the line DB. The infinite straight line DB intercepts the circle but with TikZ we need to extend the lines DB and that can be done using partway calculations. We get the point F and BF or DF intercepts the circle

```
\node (H) [label=135:$H$,draw,circle through=(C)] at (B) {};
\path let \p1 = ($ (B) - (C) $) in
coordinate [label=left:$G$] (G) at ($ (B) ! veclen(\x1,\y1) ! (F) $);
\fill[red,opacity=.5] (G) circle (2pt);
```

Like the intersection of two circles, it's easy to find the intersection of a line and a circle with `tkz-euclide`. We don't need F

```
\tkzInterLC(B,D)(B,C)\tkzGetFirstPoint{G}
```

There are no more difficulties. Here the final code with some simplifications. We draw the circle \mathcal{H} with center D and passing through G. It intersects the line AD at point L. $AL = BC$.

```
\tkzDrawCircle(D,G)
\tkzInterLC(D,A)(D,G)\tkzGetSecondPoint{L}
```

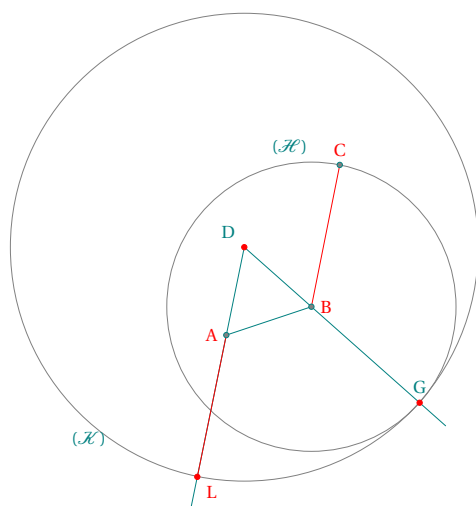

```

\begin{tikzpicture}[scale=1.5]
\tkzDefPoint(0,0){A}
\tkzDefPoint(0.75,0.25){B}
\tkzDefPoint(1,1.5){C}
\tkzDefTriangle[equilateral](A,B) \tkzGetPoint{D}
\tkzInterLC[near](D,B)(B,C) \tkzGetSecondPoint{G}
\tkzInterLC[near](D,A)(D,G) \tkzGetFirstPoint{L}
\tkzDrawCircles(B,C D,G)
\tkzDrawLines[add=0 and 2](D,A D,B)
\tkzDrawSegment(A,B)
\tkzDrawSegments[red](A,L B,C)
\tkzDrawPoints[red](D,L,G)
\tkzDrawPoints[fill=gray](A,B,C)
\tkzLabelPoints[left,red](A)
\tkzLabelPoints[below right,red](L)
\tkzLabelCircle[above](B,C)(20){$\mathcal{H}$}
\tkzLabelPoints[above left](D)
\tkzLabelPoints[above](G)
\tkzLabelPoints[above,red](C)
\tkzLabelPoints[right,red](B)
\tkzLabelCircle[below](D,G)(-90){$\mathcal{K}$}
\end{tikzpicture}

```

2.3. tkz-euclide4 vs tkz-euclide3

Now I am no longer a Mathematics teacher, and I only spend a few hours studying geometry. I wanted to avoid multiple complications by trying to make `tkz-euclide` independent of `tkz-base`. Thus was born `tkz-euclide 4`. The latter is a simplified version of its predecessor. The macros of `tkz-euclide 3` have been retained. The unit is now `cm`. If you need some macros from `tkz-base`, you may need to use the `\tkzInit`.

2.4. How to use the tkz-euclide package ?

2.4.1. Let's look at a classic example

In order to show the right way, we will see how to build an equilateral triangle. Several possibilities are open to us, we are going to follow the steps of Euclid.

- First of all, you have to use a document class. The best choice to test your code is to create a single figure with the class `standalone`.

```
\documentclass{standalone}
```

- Then load the `tkz-euclide` package:

```
\usepackage{tkz-euclide}
```

You don't need to load TikZ because the `tkz-euclide` package works on top of TikZ and loads it.

- Start the document and open a TikZ picture environment:

```
\begin{document}
\begin{tikzpicture}
```

- Now we define two fixed points:

```
\tkzDefPoint(0,0){A}
\tkzDefPoint(5,2){B}
```

- Two points define two circles, let's use these circles:

circle with center A through B and circle with center B through A. These two circles have two points in common.

```
\tkzInterCC(A,B)(B,A)
```

We can get the points of intersection with

```
\tkzGetPoints{C}{D}
```

- All the necessary points are obtained, we can move on to the final steps including the plots.

```
\tkzDrawCircles[gray,dashed](A,B B,A)
\tkzDrawPolygon(A,B,C)% The triangle
```

- Draw all points A, B, C and D:

```
\tkzDrawPoints(A,...,D)
```

- The final step, we print labels to the points and use options for positioning:

```
\tkzLabelSegments[swap](A,B){c$}
\tkzLabelPoints(A,B,D)
\tkzLabelPoints[above](C)
```

- We finally close both environments

```
\end{tikzpicture}
\end{document}
```

- The complete code

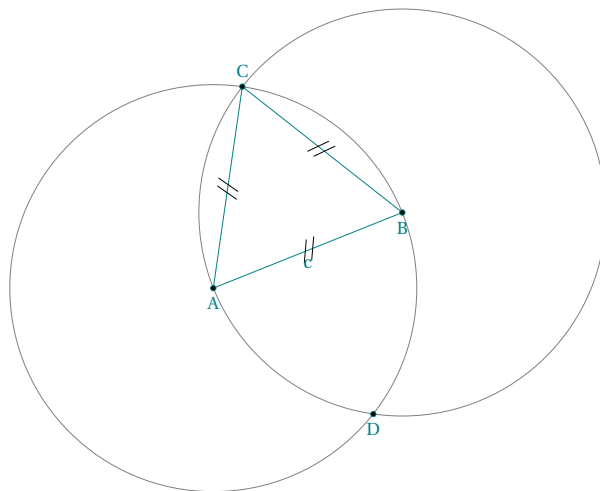

```
\begin{tikzpicture}[scale=.5]
  % fixed points
  \tkzDefPoint(0,0){A}
  \tkzDefPoint(5,2){B}
  % calculus
  \tkzInterCC(A,B)(B,A)
  \tkzGetPoints{C}{D}
  % drawings
  \tkzDrawCircles(A,B B,A)
  \tkzDrawPolygon(A,B,C)
  \tkzDrawPoints(A,...,D)
  % marking
  \tkzMarkSegments[mark=s||](A,B B,C C,A)
  % labelling
  \tkzLabelSegments[swap](A,B){c$}
  \tkzLabelPoints(A,B,D)
  \tkzLabelPoints[above](C)
\end{tikzpicture}
```

2.4.2. Part I: golden triangle

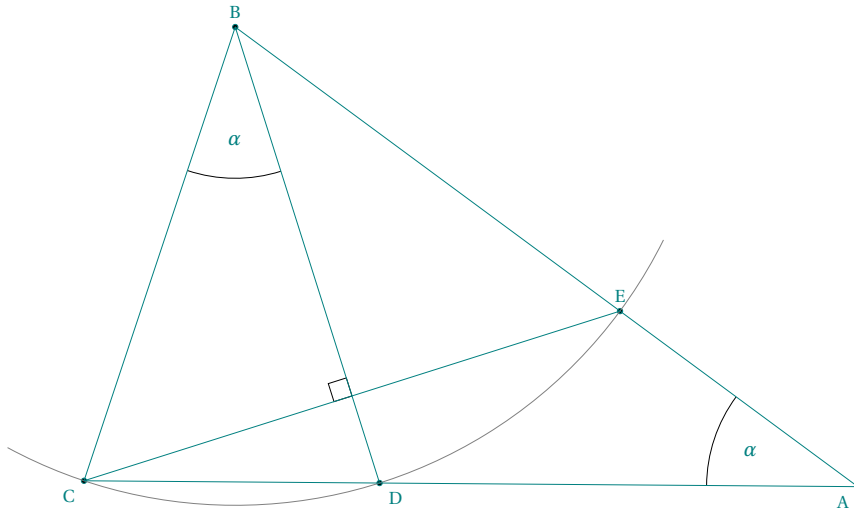

Let's analyze the figure

1. CBD and DBE are isosceles triangles;
2. $BC = BE$ and (BD) is a bisector of the angle CBE ;
3. From this we deduce that the CBD and DBE angles are equal and have the same measure α

$$\widehat{BAC} + \widehat{ABC} + \widehat{BCA} = 180^\circ \text{ in the triangle } BAC$$

$$3\alpha + \widehat{BCA} = 180^\circ \text{ in the triangle } CBD$$

then

$$\alpha + 2\widehat{BCA} = 180^\circ$$

or

$$\widehat{BCA} = 90^\circ - \alpha/2$$

4. Finally

$$\widehat{CBD} = \alpha = 36^\circ$$

the triangle CBD is a "golden" triangle.

How construct a golden triangle or an angle of 36° ?

1. We place the fixed points C and D . `\tkzDefPoint(0,0){C}` and `\tkzDefPoint(4,0){D}`;
2. We construct a square $CDef$ and we construct the midpoint m of $[Cf]$;
We can do all of this with a compass and a rule;
3. Then we trace an arc with center m through e . This arc cross the line (Cf) at n ;
4. Now the two arcs with center C and D and radius Cn define the point B .

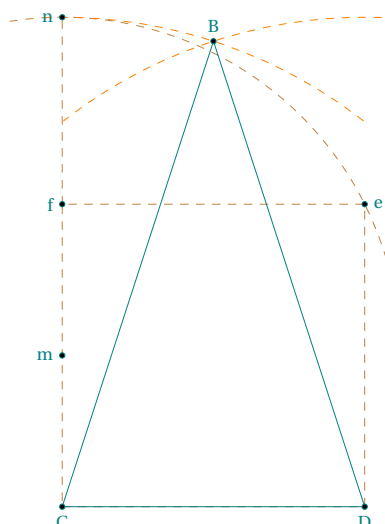

```

\begin{tikzpicture}
  \tkzDefPoint(0,0){C}
  \tkzDefPoint(4,0){D}
  \tkzDefSquare(C,D)
  \tkzGetPoints{e}{f}
  \tkzDefMidPoint(C,f)
  \tkzGetPoint{m}
  \tkzInterLC(C,f)(m,e)
  \tkzGetSecondPoint{n}
  \tkzInterCC[with nodes](C,C,n)(D,C,n)
  \tkzGetFirstPoint{B}
  \tkzDrawSegment[brown,dashed](f,n)
  \pgfinterruptboundingbox% from tikz
  \tkzDrawPolygon[brown,dashed](C,D,e,f)
  \tkzDrawArc[brown,dashed](m,e)(n)
  \tkzCompass[brown,dashed,delta=20](C,B)
  \tkzCompass[brown,dashed,delta=20](D,B)
  \endpgfinterruptboundingbox
  \tkzDrawPolygon(B,...,D)
  \tkzDrawPoints(B,C,D,e,f,m,n)
  \tkzLabelPoints[above](B)
  \tkzLabelPoints[left](f,m,n)
  \tkzLabelPoints(C,D)
  \tkzLabelPoints[right](e)
\end{tikzpicture}

```

After building the golden triangle BCD, we build the point A by noticing that $BD = DA$. Then we get the point E and finally the point F. This is done with already intersections of defined objects (line and circle).

2.4.3. Part II: two others methods with golden and euclid triangle

`tkz-euclide` knows how to define a "golden" or "euclid" triangle. We can define BCD and BCA like gold triangles.

```

\begin{tikzpicture}
  \tkzDefPoint(0,0){C}
  \tkzDefPoint(4,0){D}
  \tkzDefTriangle[golden](C,D)
  \tkzGetPoint{B}
  \tkzDefTriangle[golden](B,C)
  \tkzGetPoint{A}
  \tkzInterLC(B,A)(B,D) \tkzGetSecondPoint{E}
  \tkzInterLL(B,D)(C,E) \tkzGetPoint{F}
  \tkzDrawPoints(C,D,B)
  \tkzDrawPolygon(B,...,D)
  \tkzDrawPolygon(B,C,D)
  \tkzDrawSegments(D,A A,B C,E)
  \tkzDrawArc[delta=10](B,C)(E)
  \tkzDrawPoints(A,...,F)
  \tkzMarkRightAngle(B,F,C)
  \tkzMarkAngles(C,B,D E,A,D)
  \tkzLabelAngles[pos=1.5](C,B,D E,A,D){$\alpha$}
  \tkzLabelPoints[below](A,C,D,E)
  \tkzLabelPoints[above right](B,F)
\end{tikzpicture}

```

Here is a final method that uses rotations:

```

\begin{tikzpicture}
\tkzDefPoint(0,0){C} % possible
% \tkzDefPoint[label=below:$C$](0,0){C}
% but don't do this
\tkzDefPoint(2,6){B}
% We get D and E with a rotation
\tkzDefPointBy[rotation= center B angle 36](C) \tkzGetPoint{D}
\tkzDefPointBy[rotation= center B angle 72](C) \tkzGetPoint{E}
% To get A we use an intersection of lines
\tkzInterLL(B,E)(C,D) \tkzGetPoint{A}
\tkzInterLL(C,E)(B,D) \tkzGetPoint{H}
% drawing
\tkzDrawArc[delta=10](B,C)(E)
\tkzDrawPolygon(C,B,D)
\tkzDrawSegments(D,A B,A C,E)
% angles
\tkzMarkAngles(C,B,D E,A,D) %this is to draw the arcs
\tkzLabelAngles[pos=1.5](C,B,D E,A,D){$\alpha$}
\tkzMarkRightAngle(B,H,C)
\tkzDrawPoints(A,...,E)
% Label only now
\tkzLabelPoints[below left](C,A)
\tkzLabelPoints[below right](D)
\tkzLabelPoints[above](B,E)
\end{tikzpicture}

```

2.4.4. Complete but minimal example

A unit of length being chosen, the example shows how to obtain a segment of length \sqrt{a} from a segment of length a , using a ruler and a compass.

$IB = a, AI = 1$

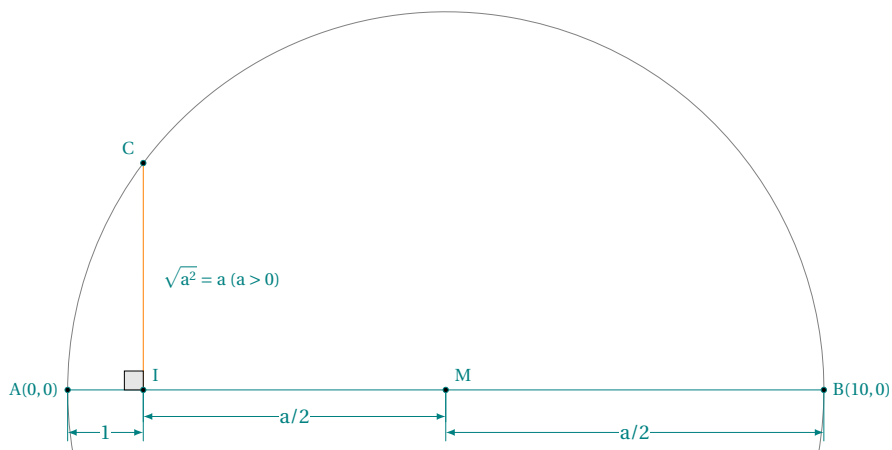

```

\begin{tikzpicture}[scale=1,ra/.style={fill=gray!20}]
  % fixed points
  \tkzDefPoint(0,0){A}
  \tkzDefPoint(1,0){I}
  % calculation
  \tkzDefPointBy[homothety=center A ratio 10 ](I) \tkzGetPoint{B}
  \tkzDefMidPoint(A,B) \tkzGetPoint{M}
  \tkzDefPointWith[orthogonal](I,M) \tkzGetPoint{H}
  \tkzInterLC(I,H)(M,B) \tkzGetFirstPoint{C}
  \tkzDrawSegment[style=orange](I,C)
  \tkzDrawArc(M,B)(A)
  \tkzDrawSegment[dim={1$, -16pt,}] (A,I)
  \tkzDrawSegment[dim={a/2$, -10pt,}] (I,M)
  \tkzDrawSegment[dim={a/2$, -16pt,}] (M,B)
  \tkzMarkRightAngle[ra](A,I,C)
  \tkzDrawPoints(I,A,B,C,M)
  \tkzLabelPoint[left](A){A(0,0)}
  \tkzLabelPoints[above right](I,M)
  \tkzLabelPoints[above left](C)
  \tkzLabelPoint[right](B){B(10,0)}
  \tkzLabelSegment[right=4pt](I,C){$\sqrt{a^2}=a \ (a>0)$}
\end{tikzpicture}

```

Comments

– The Preamble

Let us first look at the preamble. If you need it, you have to load `xcolor` before `tkz-euclide`, that is, before `TikZ`. `TikZ` may cause problems with the active characters, but... provides a library in its latest version that's supposed to solve these problems `babel`.

```

\documentclass{standalone} % or another class
  % \usepackage{xcolor} % before tikz or tkz-euclide if necessary
\usepackage{tkz-euclide} % no need to load TikZ
  % \usetkzobj{all} is no longer necessary
  % \usetikzlibrary{babel} if there are problems with the active characters

```

The following code consists of several parts:

- Definition of fixed points: the first part includes the definitions of the points necessary for the construction, these are the fixed points. The macros `\tkzInit` and `\tkzClip` in most cases are not necessary.

```

\tkzDefPoint(0,0){A}
\tkzDefPoint(1,0){I}

```

- The second part is dedicated to the creation of new points from the fixed points; a B point is placed at 10 cm from A. The middle of [AB] is defined by M and then the orthogonal line to the (AB) line is searched for at the I point. Then we look for the intersection of this line with the semi-circle of center M passing through A.

```

\tkzDefPointBy[homothety=center A ratio 10 ](I)
  \tkzGetPoint{B}
\tkzDefMidPoint(A,B)
  \tkzGetPoint{M}
\tkzDefPointWith[orthogonal](I,M)
  \tkzGetPoint{H}
\tkzInterLC(I,H)(M,B)
\tkzGetSecondPoint{C}

```

- The third one includes the different drawings;

```
\tkzDrawSegment[style=orange](I,H)
\tkzDrawPoints(O,I,A,B,M)
\tkzDrawArc(M,A)(O)
\tkzDrawSegment[dim={1$, -16pt,}](A,I)
\tkzDrawSegment[dim={a/2$, -10pt,}](I,M)
\tkzDrawSegment[dim={a/2$, -16pt,}](M,B)
```

- Marking: the fourth is devoted to marking;

```
\tkzMarkRightAngle[ra](A,I,C)
```

- Labelling: the latter only deals with the placement of labels.

```
\tkzLabelPoint[left](A){A(0,0)}
\tkzLabelPoint[right](B){B(10,0)}
\tkzLabelSegment[right=4pt](I,C){\sqrt{a^2}=a \ (a>0)}
```

3. The Elements of tkz code

To work with my package, you need to have notions of \LaTeX as well as TikZ .

In this paragraph, we start looking at the "rules" and "symbols" used to create a figure with `tkz-euclide`.

3.1. Objects and language

The primitive objects are points. You can refer to a point at any time using the name given when defining it. (it is possible to assign a different name later on).

To get new points you will use macros. `tkz-euclide` macros have a name beginning with `tkz`. There are four main categories starting with: `\tkzDef...` `\tkzDraw...` `\tkzMark...` and `\tkzLabel...`. The used points are passed as parameters between parentheses while the created points are between braces.

The code of the figures is placed in an environment **`tikzpicture`**

Contrary to TikZ , you should not end a macro with `;`. We thus lose the important notion which is the **path**. However, it is possible to place some code between the macros `tkz-euclide`.

Among the first category, `\tkzDefPoint` allows you to define fixed points. It will be studied in detail later. Here we will see in detail the macro `\tkzDefTriangle`.

This macro makes it possible to associate to a pair of points a third point in order to define a certain triangle `\tkzDefTriangle(A,B)`. The obtained point is referenced `tkzPointResult` and it is possible to choose another reference with `\tkzGetPoint{C}` for example.

```
\tkzDefTriangle[euclid](A,B) \tkzGetPoint{C}
```

Parentheses are used to pass arguments. In `(A,B)` A and B are the points with which a third will be defined. However, in `{C}` we use braces to retrieve the new point.

In order to choose a certain type of triangle among the following choices: `equilateral`, `isosceles` `right`, `half`, `pythagoras`, `school`, `golden` or `sublime`, `euclid`, `gold`, `cheops...` and two angles you just have to choose between hooks, for example:

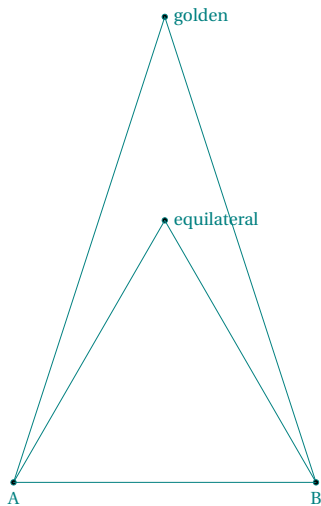

```
\begin{tikzpicture}[scale=.5]
\tkzDefPoints{0/0/A,8/0/B}
\foreach \tr in {golden, equilateral}
{\tkzDefTriangle[\tr](A,B) \tkzGetPoint{C}
\tkzDrawPoint(C)
\tkzLabelPoint[right](C){\tr}
\tkzDrawSegments(A,C C,B)}
\tkzDrawSegments(A,B)
\tkzDrawSegments(A,B)
\tkzLabelPoints(A,B)
\end{tikzpicture}
```

3.2. Notations and conventions

I deliberately chose to use the geometric French and personal conventions to describe the geometric objects represented. The objects defined and represented by `tkz-euclide` are points, lines and circles located in a plane. They are the primary objects of Euclidean geometry from which we will construct figures.

According to **Euclid**, these figures will only illustrate pure ideas produced by our brain. Thus a point has no dimension and therefore no real existence. In the same way the line has no width and therefore no existence in the real world. The objects that we are going to consider are only representations of ideal mathematical objects. `tkz-euclide` will follow the steps of the ancient Greeks to obtain geometrical constructions using the ruler and the compass.

Here are the notations that will be used:

- The points are represented geometrically either by a small disc or by the intersection of two lines (two straight lines, a straight line and a circle or two circles). In this case, the point is represented by a cross.

• B	\begin{tikzpicture} \tkzDefPoints{0/0/A,4/2/B} \tkzDrawPoints(A,B) \tkzLabelPoints(A,B) \end{tikzpicture}
• A	

or else

+ B	\begin{tikzpicture} \tkzSetUpPoint[shape=cross, color=red] \tkzDefPoints{0/0/A,4/2/B} \tkzDrawPoints(A,B) \tkzLabelPoints(A,B) \end{tikzpicture}
+ A	

The existence of a point being established, we can give it a label which will be a capital letter (with some exceptions) of the Latin alphabet such as A, B or C. For example:

- O is a center for a circle, a rotation, etc.;
- M defined a midpoint;
- H defined the foot of an altitude;
- P' is the image of P by a transformation ;

It is important to note that the reference name of a point in the code may be different from the label to designate it in the text. So we can define a point A and give it as label P. In particular the style will be different, point A will be labeled A.

```

•
P
\begin{tikzpicture}
  \tkzDefPoint(0,0){A}
  \tkzDrawPoints(A)
  \tkzLabelPoint(A){P$}
\end{tikzpicture}

```

Exceptions: some points such as the middle of the sides of a triangle share a characteristic, so it is normal that their names also share a common character. We will designate these points by M_a , M_b and M_c or M_A , M_B and M_C .

In the code, these points will be referred to as: M_A , M_B and M_C .

Another exception relates to intermediate construction points which will not be labelled. They will often be designated by a lowercase letter in the code.

- The line segments are designated by two points representing their ends in square brackets: [AB].
- The straight lines are in Euclidean geometry defined by two points so A and B define the straight line (AB). We can also designate this straight line using the Greek alphabet and name it (δ) or (Δ). It is also possible to designate the straight line with lowercase letters such as d and d'.
- The semi-straight line is designated as follows [AB).
- Relation between the straight lines. Two perpendicular (AB) and (CD) lines will be written (AB) \perp (CD) and if they are parallel we will write (AB) // (CD).
- The lengths of the sides of triangle ABC are AB, AC and BC. The numbers are also designated by a lowercase letter so we will write: AB = c, AC = b and BC = a. The letter a is also used to represent an angle, and r is frequently used to represent a radius, d a diameter, l a length, d a distance.
- Polygons are designated afterwards by their vertices so ABC is a triangle, EFGH a quadrilateral.
- Angles are generally measured in degrees (ex 60°) and in an equilateral ABC triangle we will write $\widehat{ABC} = \widehat{B} = 60^\circ$.
- The arcs are designated by their extremities. For example if A and B are two points of the same circle then \widehat{AB} .
- Circles are noted either \mathcal{C} if there is no possible confusion or $\mathcal{C}(O; A)$ for a circle with center O and passing through the point A or $\mathcal{C}(O; 1)$ for a circle with center O and radius 1 cm.
- Name of the particular lines of a triangle: I used the terms bisector, bisector out, mediator (sometimes called perpendicular bisectors), altitude, median and symmedian.
- (x_1, y_1) coordinates of the point A_1 , (x_A, y_A) coordinates of the point A.

3.3. Set, Calculate, Draw, Mark, Label

The title could have been: Separation of Calculus and Drawings

When a document is prepared using the \LaTeX system, the source code of the document can be divided into two parts: the document body and the preamble. Under this methodology, publications can be structured, styled and typeset with minimal effort. I propose a similar methodology for creating figures with `tkz-euclide`.

The first part defines the fixed points, the second part allows the creation of new points. `Set` and `Calculate` are the two main parts. All that is left to do is to draw (or fill), mark and label. It is possible that `tkz-euclide` is insufficient for some of these latter actions but you can use `TikZ`

One last remark that I think is important, it is best to avoid introducing coordinates within a code as much as possible. I think that the coordinates should appear at the beginning of the code with the fixed points. Then the use of references is recommended. Most macros have the option `nodes` or `with nodes`. I also think it's best to define the styles of the different objects from the beginning.

4. About this documentation and the examples

It is obtained by compiling with "lualatex". I use a class `doc.cls` based on `scartcl`.

Below the list of styles used in the documentation. To understand how to use the styles see the section 36

```
\tkzSetUpColors[background=white,text=black]
\tkzSetUpCompass[color=orange, line width=.2pt,delta=10]
\tkzSetUpArc[color=gray,line width=.2pt]
\tkzSetUpPoint[size=2,color=teal]
\tkzSetUpLine[line width=.2pt,color=teal]
\tkzSetUpStyle[color=orange,line width=.2pt]{new}
\tikzset{every picture/.style={line width=.2pt}}
\tikzset{label angle style/.append style={color=teal,font=\footnotesize}}
\tikzset{label style/.append style={below,color=teal,font=\scriptsize}}
Some examples use predefined styles like
\tikzset{new/.style={color=orange,line width=.2pt}}
```

Part II.

Setting

5. First step: fixed points

The first step in a geometric construction is to define the fixed points from which the figure will be constructed. The general idea is to avoid manipulating coordinates and to prefer to use the references of the points fixed in the first step or obtained using the tools provided by the package. Even if it's possible, I think it's a bad idea to work directly with coordinates. Preferable is to use named points.

`tkz-euclide` uses macros and vocabulary specific to geometric construction. It is of course possible to use the tools of `TikZ` but it seems more logical to me not to mix the different syntaxes.

A point in `tkz-euclide` is a particular "node" for `TikZ`. In the next section we will see how to define points using coordinates. The style of the points (color and shape) will not be discussed. You will find some indications in some examples; for more information you can read the following section 36.

6. Definition of a point : `\tkzDefPoint` or `\tkzDefPoints`

Points can be specified in any of the following ways:

- Cartesian coordinates;
- Polar coordinates;
- Named points;
- Relative points.

A point is defined if it has a name linked to a unique pair of decimal numbers. Let (x,y) or (a:d) i.e. (x abscissa, y ordinate) or (a angle: d distance). This is possible because the plan has been provided with an orthonormed Cartesian coordinate system. The working axes are (ortho)normed with unity equal to 1 cm.

The Cartesian coordinate (a,b) refers to the point a centimeters in the x-direction and b centimeters in the y-direction.

A point in polar coordinates requires an angle α , in degrees, and a distance d from the origin with a dimensional unit by default it's the cm.

The `\tkzDefPoint` macro is used to define a point by assigning coordinates to it. This macro is based on `\coordinate`, a macro of `TikZ`. It can use `TikZ`-specific options such as `shift`. If calculations are required then the `xfp` package is chosen. We can use Cartesian or polar coordinates.

Cartesian coordinates

Polar coordinates

<pre> \begin{tikzpicture}[scale=1] \tkzInit[xmax=5,ymax=5] % necessary to limit % the size of the axes \tkzDrawX[>=latex] \tkzDrawY[>=latex] \tkzDefPoints{0/0/0,1/0/I,0/1/J} \tkzDefPoint(3,4){A} \tkzDrawPoints(O,A) \tkzLabelPoint[above](A){\$A_1(x_1,y_1)\$} \tkzShowPointCoord[xlabel=\$x_1\$, ylabel=\$y_1\$](A) \tkzLabelPoints(O,I) \tkzLabelPoints[left](J) \tkzDrawPoints[shape=cross](I,J) \end{tikzpicture} </pre>	<pre> \begin{tikzpicture}[,scale=1] \tkzInit[xmax=5,ymax=5] \tkzDrawX[>=latex] \tkzDrawY[>=latex] \tkzDefPoints{0/0/0,1/0/I,0/1/J} \tkzDefPoint(40:4){P} \tkzDrawSegment[dim={d\$, 16pt,above=6pt}](O,P) \tkzDrawPoints(O,P) \tkzMarkAngle[mark=none,->](I,O,P) \tkzFillAngle[opacity=.5](I,O,P) \tkzLabelAngle[pos=1.25](I,O,P){% \$\alpha\$} \tkzLabelPoint[right](P){\$P(\alpha : d)\$} \tkzDrawPoints[shape=cross](I,J) \tkzLabelPoints(O,I) \tkzLabelPoints[left](J) \end{tikzpicture} </pre>
---	---

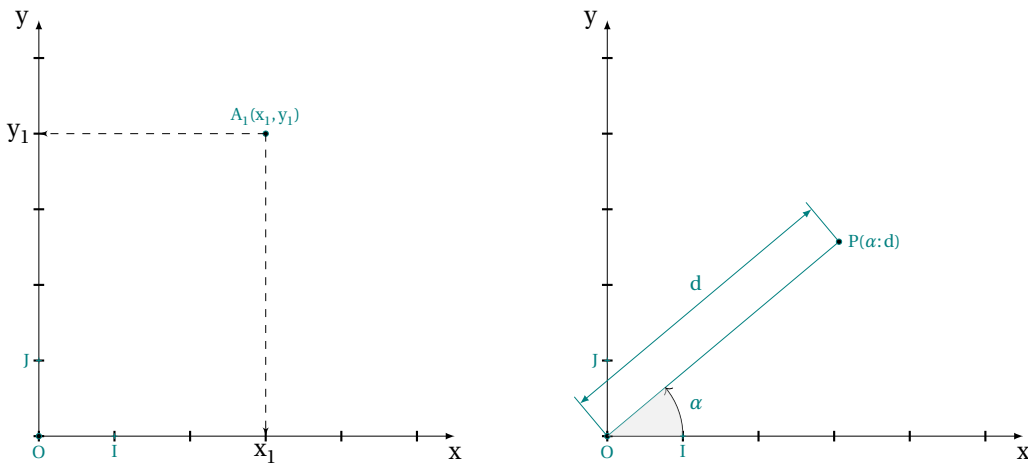

6.1. Defining a named point `\tkzDefPoint`

`\tkzDefPoint`[*(local options)*](*(x,y)*){*(ref)*} or (*(α:d)*){*(ref)*}

arguments	default	definition
(x,y)	no default	x and y are two dimensions, by default in cm.
(α:d)	no default	α is an angle in degrees, d is a dimension
{ref}	no default	Reference assigned to the point: A, T_a ,P1 or P1

The obligatory arguments of this macro are two dimensions expressed with decimals, in the first case they are two measures of length, in the second case they are a measure of length and the measure of an angle in degrees. Do not confuse the reference with the name of a point. The reference is used by calculations, but frequently, the name is identical to the reference.

options	default	definition
label	no default	allows you to place a label at a predefined distance
shift	no default	adds (x,y) or (α:d) to all coordinates

6.1.1. Cartesian coordinates

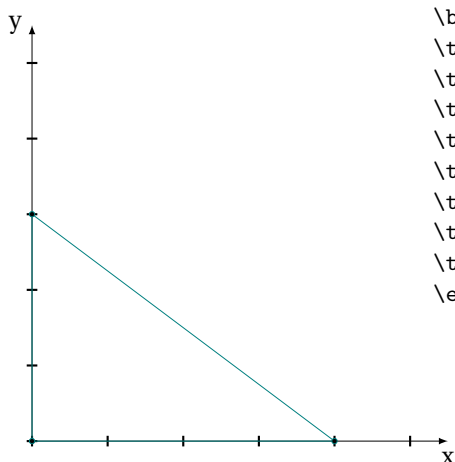

```

\begin{tikzpicture}
\tkzInit[xmax=5,ymax=5] % limits the size of the axes
\tkzDrawX[>=latex]
\tkzDrawY[>=latex]
\tkzDefPoint(0,0){A}
\tkzDefPoint(4,0){B}
\tkzDefPoint(0,3){C}
\tkzDrawPolygon(A,B,C)
\tkzDrawPoints(A,B,C)
\end{tikzpicture}

```

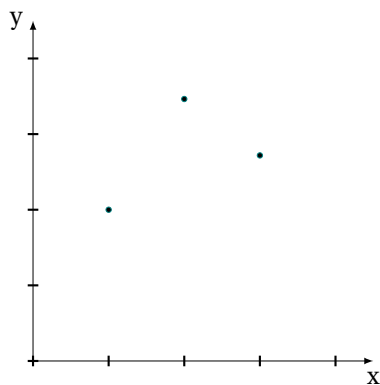
6.1.2. Calculations with `xfp`

```
\begin{tikzpicture}[scale=1]
  \tkzInit[xmax=4,ymax=4]
  \tkzDrawX\tkzDrawY
  \tkzDefPoint(-1+2,sqrt(4)){O}
  \tkzDefPoint({3*ln(exp(1))},{exp(1)}){A}
  \tkzDefPoint({4*sin(pi/6)},{4*cos(pi/6)}){B}
  \tkzDrawPoints(O,B,A)
\end{tikzpicture}
```

6.1.3. Polar coordinates

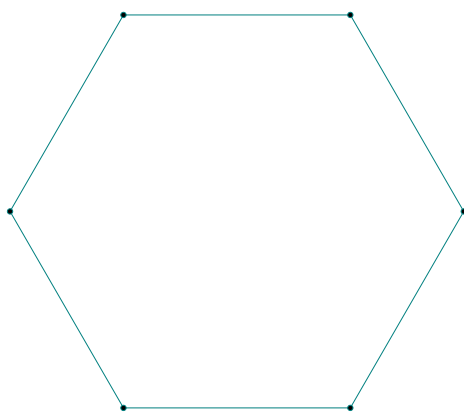

```
\begin{tikzpicture}
  \foreach \an [count=\i] in {0,60,...,300}
  { \tkzDefPoint(\an:3){A_\i}}
  \tkzDrawPolygon(A_1,A_2,...,A_6)
  \tkzDrawPoints(A_1,A_2,...,A_6)
\end{tikzpicture}
```

6.1.4. Relative points

First, we can use the `scope` environment from TikZ. In the following example, we have a way to define an equilateral triangle.

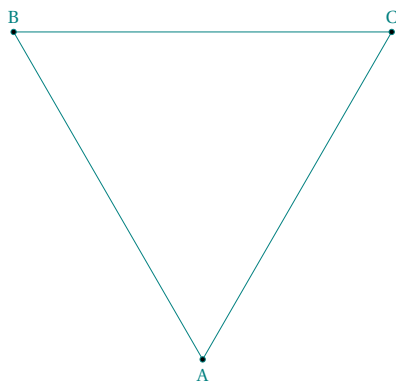

```
\begin{tikzpicture}[scale=1]
  \begin{scope}[rotate=30]
    \tkzDefPoint(2,3){A}
    \begin{scope}[shift=(A)]
      \tkzDefPoint(90:5){B}
      \tkzDefPoint(30:5){C}
    \end{scope}
  \end{scope}
  \tkzDrawPolygon(A,B,C)
  \tkzLabelPoints[above](B,C)
  \tkzLabelPoints[below](A)
  \tkzDrawPoints(A,B,C)
\end{tikzpicture}
```

6.2. Point relative to another: `\tkzDefShiftPoint`

<code>\tkzDefShiftPoint</code> [<code><Point></code>] (<code><x,y></code>) <code>{<ref>}</code> or (<code><α:d></code>) <code>{<ref>}</code>		
arguments	default	definition
<code>(x,y)</code>	no default	<code>x</code> and <code>y</code> are two dimensions, by default in cm.
<code>(α:d)</code>	no default	<code>α</code> is an angle in degrees, <code>d</code> is a dimension
<code>{ref}</code>	no default	Reference assigned to the point: <code>A</code> , <code>T_a</code> , <code>P1</code> or <code>P1</code>
options	default	definition
<code>[pt]</code>	no default	<code>\tkzDefShiftPoint</code> [<code>A</code>] (<code>0:4</code>) <code>{B}</code>

6.2.1. Isosceles triangle

This macro allows you to place one point relative to another. This is equivalent to a translation. Here is how to construct an isosceles triangle with main vertex `A` and angle at vertex of 30° .

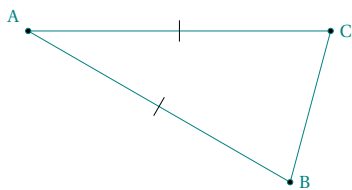

```
\begin{tikzpicture}[rotate=-30]
\tkzDefPoint(2,3){A}
\tkzDefShiftPoint[A](0:4){B}
\tkzDefShiftPoint[A](30:4){C}
\tkzDrawSegments(A,B B,C C,A)
\tkzMarkSegments[mark=|](A,B A,C)
\tkzDrawPoints(A,B,C)
\tkzLabelPoints[right](B,C)
\tkzLabelPoints[above left](A)
\end{tikzpicture}
```

6.2.2. Equilateral triangle

Let's see how to get an equilateral triangle (there is much simpler)

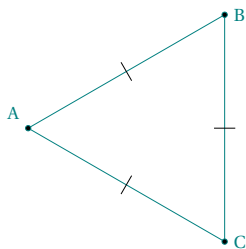

```
\begin{tikzpicture}[scale=1]
\tkzDefPoint(2,3){A}
\tkzDefShiftPoint[A](30:3){B}
\tkzDefShiftPoint[A](-30:3){C}
\tkzDrawPolygon(A,B,C)
\tkzDrawPoints(A,B,C)
\tkzLabelPoints[right](B,C)
\tkzLabelPoints[above left](A)
\tkzMarkSegments[mark=|](A,B A,C B,C)
\end{tikzpicture}
```

6.2.3. Parallelogram

There's a simpler way

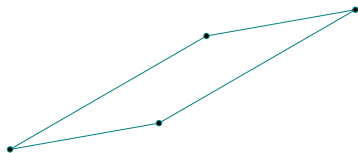

```
\begin{tikzpicture}
\tkzDefPoint(0,0){A}
\tkzDefPoint(30:3){B}
\tkzDefShiftPointCoord[B](10:2){C}
\tkzDefShiftPointCoord[A](10:2){D}
\tkzDrawPolygon(A,...,D)
\tkzDrawPoints(A,...,D)
\end{tikzpicture}
```

6.3. Definition of multiple points: `\tkzDefPoints`

<code>\tkzDefPoints[(local options)]{(x₁/y₁/r₁,x₂/y₂/r₂, ...)}</code>		
x_i and y_i are the coordinates of a referenced point r_i		
arguments	default	example
$x_i/y_i/r_i$		<code>\tkzDefPoints{0/0/0,2/2/A}</code>
options	default	definition
shift	no default	Adds (x,y) or (a:d) to all coordinates

6.4. Create a triangle

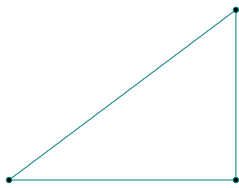

```
\begin{tikzpicture}[scale=.75]
\tkzDefPoints{0/0/A,4/0/B,4/3/C}
\tkzDrawPolygon(A,B,C)
\tkzDrawPoints(A,B,C)
\end{tikzpicture}
```

6.5. Create a square

Note here the syntax for drawing the polygon.

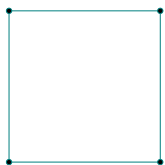

```
\begin{tikzpicture}[scale=1]
\tkzDefPoints{0/0/A,2/0/B,2/2/C,0/2/D}
\tkzDrawPolygon(A,...,D)
\tkzDrawPoints(A,...,D)
\end{tikzpicture}
```

Part III.

Calculating

Now that the fixed points are defined, we can with their references using macros from the package or macros that you will create get new points. The calculations may not be apparent but they are usually done by the package. You may need to use some mathematical constants, here is the list of constants defined by the package. You may need to use some mathematical constants, here is the list of constants defined by the package.

7. Auxiliary tools

7.1. Constants

`tkz-euclide` knows some constants, here is the list:

```
\def\tkzPhi{1.618034}
\def\tkzInvPhi{0.618034}
\def\tkzSqrtPhi{1.27202}
\def\tkzSqrTwo{1.414213}
\def\tkzSqrThree{1.7320508}
\def\tkzSqrFive{2.2360679}
\def\tkzSqrTwobyTwo{0.7071065}
\def\tkzPi{3.1415926}
\def\tkzEuler{2.71828182}
```

7.2. New point by calculation

When a macro of `tkznameofpack` creates a new point, it is stored internally with the reference `tkzPointResult`. You can assign your own reference to it. This is done with the macro `\tkzGetPoint`. A new reference is created, your choice of reference must be placed between braces.

```
\tkzGetPoint{<ref>}
```

If the result is in `tkzPointResult`, you can access it with `\tkzGetPoint`.

arguments	default	example
<code>ref</code>	no default	<code>\tkzGetPoint{M}</code> see the next example

Sometimes you need to get two points. It's possible with

```
\tkzGetPoints{<ref1>}{<ref2>}
```

The result is in `tkzPointFirstResult` and `tkzPointSecondResult`.

arguments	default	example
<code>{ref1,ref2}</code>	no default	<code>\tkzGetPoints{M,N}</code> It's the case with <code>\tkzInterCC</code>

If you need only the first or the second point you can also use :

```
\tkzGetFirstPoint{<ref1>}
```

arguments	default	example
<code>ref1</code>	no default	<code>\tkzGetFirstPoint{M}</code>

```
\tkzGetSecondPoint{<ref2>}
```

arguments	default	example
ref2	no default	<code>\tkzGetSecondPoint{M}</code>

Sometimes the results consist of a point and a dimension. You get the point with `\tkzGetPoint` and the dimension with `\tkzGetLength`.

```
\tkzGetLength{<name of a macro>}
```

arguments	default	example
name of a macro	no default	<code>\tkzGetLength{rAB}</code> <code>rAB</code> gives the length in cm

8. Special points

Here are some special points.

8.1. Middle of a segment `\tkzDefMidPoint`

It is a question of determining the middle of a segment.

```
\tkzDefMidPoint(<pt1,pt2>)
```

The result is in `tkzPointResult`. We can access it with `\tkzGetPoint`.

arguments	default	definition
(pt1,pt2)	no default	pt1 and pt2 are two points

8.1.1. Use of `\tkzDefMidPoint`

Review the use of `\tkzDefPoint`.

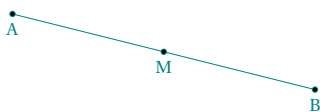

```
\begin{tikzpicture}[scale=1]
\tkzDefPoint(2,3){A}
\tkzDefPoint(6,2){B}
\tkzDefMidPoint(A,B)
\tkzGetPoint{M}
\tkzDrawSegment(A,B)
\tkzDrawPoints(A,B,M)
\tkzLabelPoints[below](A,B,M)
\end{tikzpicture}
```

8.2. Golden ratio `\tkzDefGoldenRatio`

From Wikipedia : In mathematics, two quantities are in the golden ratio if their ratio is the same as the ratio of their sum to the larger of the two quantities. Expressed algebraically, for quantities a, b such as $a > b > 0$; $a + b$ is to a as a is to b .

$$\frac{a+b}{a} = \frac{a}{b} = \phi = \frac{1+\sqrt{5}}{2}$$

One of the two solutions to the equation $x^2 - x - 1 = 0$ is the golden ratio ϕ , $\phi = \frac{1+\sqrt{5}}{2}$.

<code>\tkzDefGoldenRatio(<pt1,pt2>)</code>		
arguments	default	example
<code>(pt1,pt2)</code>	no default	<code>\tkzDefGoldenRatio(A,C) \tkzGetPoint{B}</code>
$AB = a, BC = b$ and $\frac{AC}{AB} = \frac{AB}{BC} = \phi$		

8.2.1. Use the golden ratio to divide a line segment



```
\begin{tikzpicture}
\tkzDefPoints{0/0/A,6/0/C}
\tkzDefMidPoint(A,C) \tkzGetPoint{I}
%\tkzDefPointWith[linear,K=\tkzInvPhi](A,C)
\tkzDefGoldenRatio(A,C) \tkzGetPoint{B}
\tkzDrawSegments(A,C)
\tkzDrawPoints(A,B,C)
\tkzLabelPoints(A,B,C)
\end{tikzpicture}
```

8.2.2. Golden arbelos

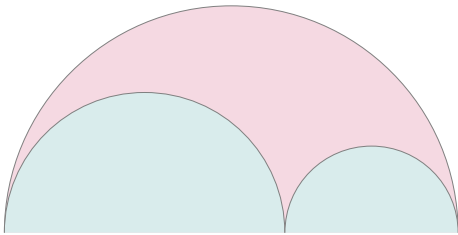

```
\begin{tikzpicture}[scale=.6]
\tkzDefPoints{0/0/A,10/0/B}
\tkzDefGoldenRatio(A,B) \tkzGetPoint{C}
\tkzDefMidPoint(A,B) \tkzGetPoint{0_1}
\tkzDefMidPoint(A,C) \tkzGetPoint{0_2}
\tkzDefMidPoint(C,B) \tkzGetPoint{0_3}
\tkzDrawSemiCircles[fill=purple!15](0_1,B)
\tkzDrawSemiCircles[fill=teal!15](0_2,C 0_3,B)
\end{tikzpicture}
```

It is also possible to use the following macro.

8.3. Barycentric coordinates with `\tkzDefBarycentricPoint`

pt_1, pt_2, \dots, pt_n being n points, they define n vectors $\vec{v}_1, \vec{v}_2, \dots, \vec{v}_n$ with the origin of the referential as the common endpoint. $\alpha_1, \alpha_2, \dots, \alpha_n$ are n numbers, the vector obtained by:

$$\frac{\alpha_1 \vec{v}_1 + \alpha_2 \vec{v}_2 + \dots + \alpha_n \vec{v}_n}{\alpha_1 + \alpha_2 + \dots + \alpha_n}$$

defines a single point.

<code>\tkzDefBarycentricPoint(<pt1=α_1,pt2=α_2,...>)</code>		
arguments	default	definition
<code>(pt1=α_1,pt2=α_2,...)</code>	no default	Each point has a assigned weight
<i>You need at least two points. Result in <code>tkzPointResult</code>.</i>		

8.3.1. with two points

In the following example, we obtain the barycenter of points A and B with coefficients 1 and 2, in other words:

$$\vec{AI} = \frac{2}{3}\vec{AB}$$

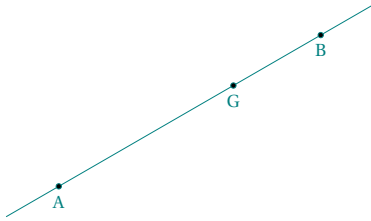

```
\begin{tikzpicture}
  \tkzDefPoint(2,3){A}
  \tkzDefShiftPointCoord[2,3](30:4){B}
  \tkzDefBarycentricPoint(A=1,B=2)
  \tkzGetPoint{G}
  \tkzDrawLine(A,B)
  \tkzDrawPoints(A,B,G)
  \tkzLabelPoints(A,B,G)
\end{tikzpicture}
```

8.3.2. with three points

This time M is simply the center of gravity of the triangle.

For reasons of simplification and homogeneity, there is also `\tkzCentroid`.

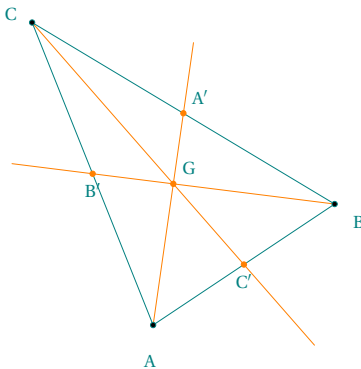

```
\begin{tikzpicture}[scale=.8]
  \tkzDefPoints{2/1/A,5/3/B,0/6/C}
  \tkzDefBarycentricPoint(A=1,B=1,C=1)
  \tkzGetPoint{G}
  \tkzDefMidPoint(A,B) \tkzGetPoint{C'}
  \tkzDefMidPoint(A,C) \tkzGetPoint{B'}
  \tkzDefMidPoint(C,B) \tkzGetPoint{A'}
  \tkzDrawPolygon(A,B,C)
  \tkzDrawLines[add=0 and 1,new](A,G B,G C,G)
  \tkzDrawPoints[new](A',B',C',G)
  \tkzDrawPoints(A,B,C)
  \tkzLabelPoint[above right](G){G}
  \tkzAutoLabelPoints[center=G](A,B,C)
  \tkzLabelPoints[above right](A')
  \tkzLabelPoints[below](B',C')
\end{tikzpicture}
```

8.4. Internal and external Similitude Center

The centers of the two homotheties in which two circles correspond are called external and internal centers of similitude. You can use `\tkzDefIntSimilitudeCenter` and `\tkzDefExtSimilitudeCenter` but the next macro is better.

<code>\tkzDefSimilitudeCenter[options](O,A)(O',B)</code>		
arguments	example	explanation
<code>(pt1,pt2)(pt3,pt4)</code>	<code>(O,A)(O',B)</code>	$r = OA, r' = O'B$
options	default	definition
<code>ext</code>	<code>ext</code>	external center
<code>int</code>	<code>ext</code>	internal center

8.4.1. Internal and external with node

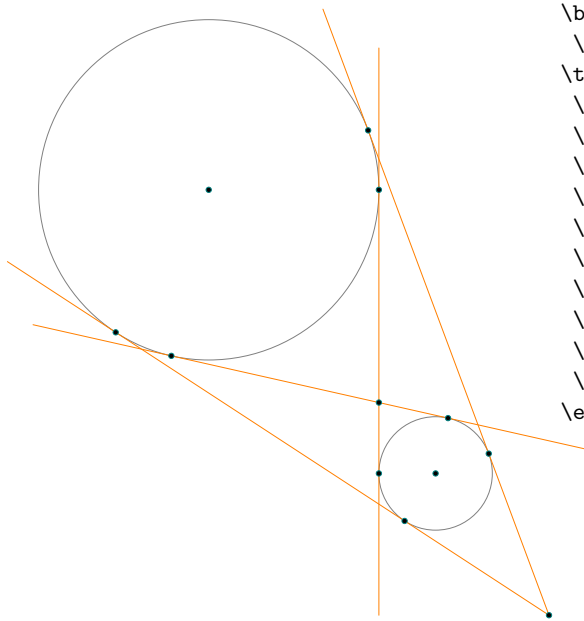

```

\begin{tikzpicture}[scale=.75]
  \tkzDefPoints{0/0/0,4/-5/A,3/0/B,5/-5/C}
  \tkzDefSimilitudeCenter[int](O,B)(A,C) \tkzGetPoint{I}
  \tkzDefSimilitudeCenter[ext](O,B)(A,C) \tkzGetPoint{J}
  \tkzDefLine[tangent from = I](O,B) \tkzGetPoints{D}{E}
  \tkzDefLine[tangent from = I](A,C) \tkzGetPoints{D'}{E'}
  \tkzDefLine[tangent from = J](O,B) \tkzGetPoints{F}{G}
  \tkzDefLine[tangent from = J](A,C)
  \tkzGetPoints{F'}{G'}
  \tkzDrawCircles(O,B A,C)
  \tkzDrawSegments[add = .5 and .5,new](D,D' E,E')
  \tkzDrawSegments[add= 0 and 0.25,new](J,F J,G)
  \tkzDrawPoints(O,A,I,J,D,E,F,G,D',E',F',G')
\end{tikzpicture}

```

8.4.2. D'Alembert Theorem

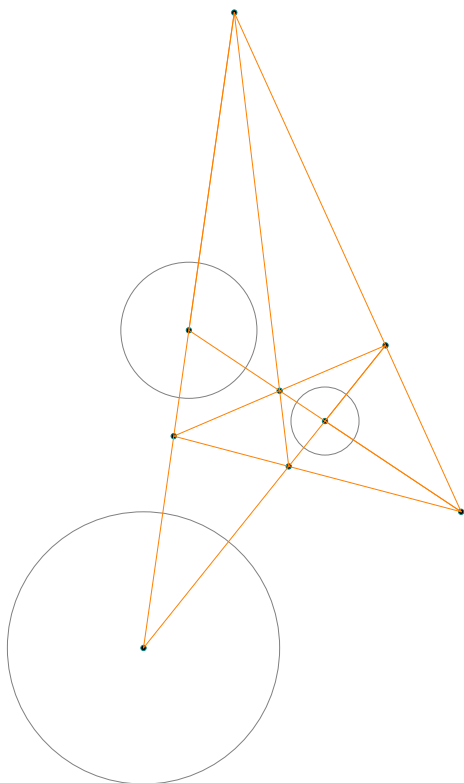

```

\begin{tikzpicture}[scale=.6,rotate=90]
  \tkzDefPoints{0/0/A,3/0/a,7/-1/B,5.5/-1/b}
  \tkzDefPoints{5/-4/C,4.25/-4/c}
  \tkzDrawCircles(A,a B,b C,c)
  \tkzDefExtSimilitudeCenter(A,a)(B,b) \tkzGetPoint{I}
  \tkzDefExtSimilitudeCenter(A,a)(C,c) \tkzGetPoint{J}
  \tkzDefExtSimilitudeCenter(C,c)(B,b) \tkzGetPoint{K}
  \tkzDefIntSimilitudeCenter(A,a)(B,b) \tkzGetPoint{I'}
  \tkzDefIntSimilitudeCenter(A,a)(C,c) \tkzGetPoint{J'}
  \tkzDefIntSimilitudeCenter(C,c)(B,b) \tkzGetPoint{K'}
  \tkzDrawPoints(A,B,C,I,J,K,I',J',K')
  \tkzDrawSegments[new](I,K A,I A,J B,I B,K C,J C,K)
  \tkzDrawSegments[new](I,J' I',J I',K)
\end{tikzpicture}

```

You can use `\tkzDefBarycentricPoint` to find a homothetic center

```

\tkzDefBarycentricPoint(O=\r,A=\R) \tkzGetPoint{I}
\tkzDefBarycentricPoint(O=-\r,A=\R) \tkzGetPoint{J}

```

8.4.3. Example with node

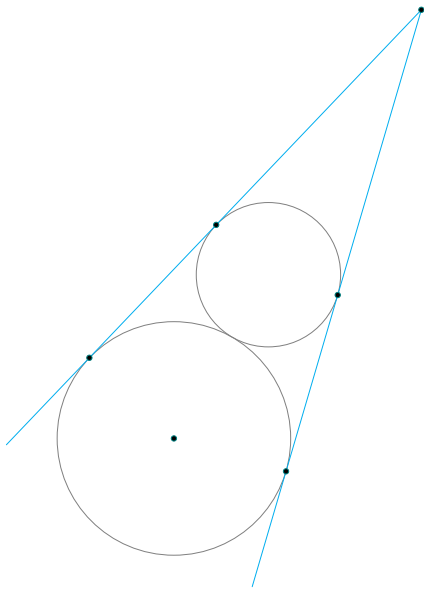

```

\begin{tikzpicture}[rotate=60,scale=.5]
  \tkzDefPoints{0/0/A,5/0/C}
  \tkzDefGoldenRatio(A,C) \tkzGetPoint{B}
  \tkzDefSimilitudeCenter(A,B)(C,B) \tkzGetPoint{J}
  \tkzDefTangent[from = J](A,B) \tkzGetPoints{F}{G}
  \tkzDefTangent[from = J](C,B) \tkzGetPoints{F'}{G'}
  \tkzDrawCircles(A,B C,B)
  \tkzDrawSegments[add= 0 and 0.25,cyan](J,F J,G)
  \tkzDrawPoints(A,J,F,G,F',G')
\end{tikzpicture}

```

8.5. Harmonic division with `\tkzDefHarmonic`

```
\tkzDefHarmonic[options](pt1,pt2,pt3) or (pt1,pt2,k)
```

options	default	definition
both	both	$(\langle A,B,2 \rangle)$ we look for C and D such that $(A,B;C,D) = -1$ and $CA=2CB$
ext	both	$(\langle A,B,C \rangle)$ we look for D such that $(A,B;C,D) = -1$
int	both	$(\langle A,B,D \rangle)$ we look for C such that $(A,B;C,D) = -1$

8.5.1. options ext and int



```
\begin{tikzpicture}
\tkzDefPoints{0/0/A,6/0/B,4/0/C}
\tkzDefHarmonic[ext](A,B,C) \tkzGetPoint{J}
\tkzDefHarmonic[int](A,B,J) \tkzGetPoint{I}
\tkzDrawPoints(A,B,I,J)
\tkzDrawLine[add=.5 and 1](A,B)
\tkzLabelPoints(A,B,I,J)
\end{tikzpicture}
```

8.5.2. Bisector and harmonic division

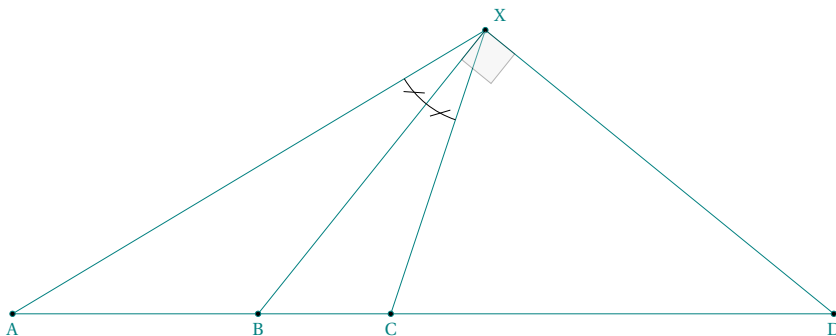

```
\begin{tikzpicture}[scale=1.25]
\tkzDefPoints{0/0/A,4/0/C,5/3/X}
\tkzDefLine[bisector](A,X,C) \tkzGetPoint{x}
\tkzInterLL(X,x)(A,C) \tkzGetPoint{B}
\tkzDefHarmonic[ext](A,C,B) \tkzGetPoint{D}
\tkzDrawPolygon(A,X,C)
\tkzDrawSegments(X,B C,D D,X)
\tkzDrawPoints(A,B,C,D,X)
\tkzMarkAngles[mark=s|](A,X,B B,X,C)
\tkzMarkRightAngle[size=.4,
fill=gray!20,
opacity=.3](B,X,D)
\tkzLabelPoints(A,B,C,D)
\tkzLabelPoints[above right](X)
\end{tikzpicture}
```

8.5.3. option both

`both` is the default option



```
\begin{tikzpicture}
\tkzDefPoints{0/0/A,6/0/B}
\tkzDefHarmonic(A,B,{1/2})\tkzGetPoints{I}{J}
\tkzDrawPoints(A,B,I,J)
\tkzDrawLine[add=1 and .5](A,B)
\tkzLabelPoints(A,B,I,J)
\end{tikzpicture}
```

8.6. Equidistant points with `\tkzDefEquiPoints`

```
\tkzDefEquiPoints[⟨local options⟩](⟨pt1,pt2⟩)
```

arguments	default	definition
(pt1,pt2)	no default	unordered list of two items
options	default	definition
dist	2 (cm)	half the distance between the two points
from=pt	no default	reference point
show	false	if true displays compass traces
/compass/delta	0	compass trace size

This macro makes it possible to obtain two points on a straight line equidistant from a given point.

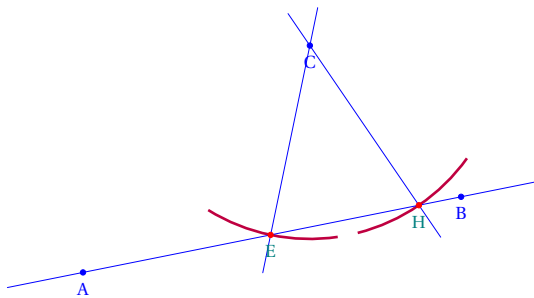
8.6.1. Using `\tkzDefEquiPoints` with options

```
\begin{tikzpicture}
\tkzSetUpCompass[color=purple,line width=1pt]
\tkzDefPoints{0/1/A,5/2/B,3/4/C}
\tkzDefEquiPoints[from=C,dist=1,show,
/compass/delta=20](A,B)
\tkzGetPoints{E}{H}
\tkzDrawLines[color=blue](C,E C,H A,B)
\tkzDrawPoints[color=blue](A,B,C)
\tkzDrawPoints[color=red](E,H)
\tkzLabelPoints(E,H)
\tkzLabelPoints[color=blue](A,B,C)
\end{tikzpicture}
```

8.7. Middle of an arc

```
\tkzDefMidArc(⟨pt1,pt2,pt3⟩)
```

arguments	default	definition
pt1,pt2,pt3	no default	pt1 is the center, $\widehat{pt2pt3}$ the arc

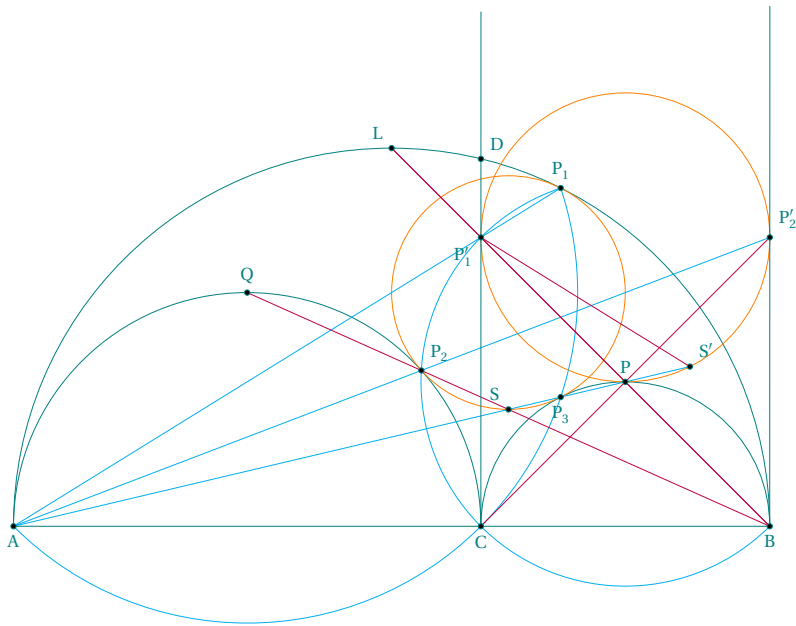

```

\begin{tikzpicture}[scale=1]
\tkzDefPoints{0/Q/A,10/Q/B}
\tkzDefGoldenRatio(A,B)
\tkzDefMidPoint(A,B)
\tkzDefMidPoint(A,C)
\tkzDefMidPoint(C,B)
\tkzDefMidArc(0_3,B,C)
\tkzDefMidArc(0_2,C,A)
\tkzDefMidArc(0_1,B,A)
\tkzDefPointBy[rotation=center C angle 90](B)
\tkzInterCC[common=B](P,B)(0_1,B)
\tkzInterCC[common=C](P,C)(0_2,C)
\tkzInterCC[common=C](Q,C)(0_3,C)
\tkzInterLC[near](c,C)(0_1,A)
\tkzInterLL(A,P_1)(C,D)
\tkzDefPointBy[inversion = center A through D](P_2)
\tkzDefCircle[circum](P_3,P_2,P_1)
\tkzInterLL(B,Q)(A,P)
\tkzDefMidPoint(P_2',P_1')
\tkzDefPointBy[inversion = center A through D](S)
\tkzDrawArc[cyan,delta=0](Q,A)(P_1)
\tkzDrawArc[cyan,delta=0](P,P_1)(B)
\tkzDrawSemiCircles[teal](0_1,B 0_2,C 0_3,B)
\tkzDrawCircles[new](o,P 0_4,P_1)
\tkzDrawSegments(A,B)
\tkzDrawSegments[cyan](A,P_1 A,S' A,P_2')
\tkzDrawSegments[purple](B,L C,P_2' B,Q B,L S',P_1')
\tkzDrawLines[add=0 and .8](B,P_2')
\tkzDrawLines[add=0 and .4](C,D)
\tkzDrawPoints(A,B,C,P,Q,P_3,P_2,P_1,P_1',D,P_2',L,S,S')
\tkzLabelPoints(A,B,C,P_3)
\tkzLabelPoints[above](P,Q,P_1)
\tkzLabelPoints[above right](P_2,P_2',D,S')
\tkzLabelPoints[above left](L,S)
\tkzLabelPoints[below left](P_1')
\end{tikzpicture}

```

9. Point on line or circle

9.1. Point on a line with `\tkzDefPointOnLine`

```
\tkzDefPointOnLine[<local options>](A,B)
```

arguments	default	definition
pt1,pt2	no default	Two points to define a line
options	default	definition
pos=nb		nb is a decimal

9.1.1. Use of option pos

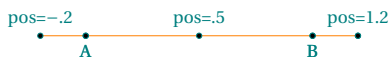

```

\begin{tikzpicture}
\tkzDefPoints{0/0/A,3/0/B}
\tkzDefPointOnLine[pos=1.2](A,B)\tkzGetPoint{P}
\tkzDefPointOnLine[pos=-0.2](A,B)\tkzGetPoint{R}
\tkzDefPointOnLine[pos=0.5](A,B)\tkzGetPoint{S}
\tkzDrawLine[new](A,B)
\tkzDrawPoints(A,B,P)
\tkzLabelPoints(A,B)
\tkzLabelPoint[above](P){pos=$1.2$}
\tkzLabelPoint[above](R){pos=$-.2$}
\tkzLabelPoint[above](S){pos=$.5$}
\tkzDrawPoints(A,B,P,R,S)
\tkzLabelPoints(A,B)
\end{tikzpicture}

```

9.2. Point on a circle with \tkzDefPointOnCircle

The order of the arguments has changed: now it is center, angle and point or radius. I have added two options for working with radians which are `through in rad` and `R in rad`.

```
\tkzDefPointOnCircle[⟨local options⟩]
```

options	default	examples definition
<code>through</code>		<code>through = center K1 angle 30 point B]</code>
<code>R</code>		<code>R = center K1 angle 30 radius \rAp</code>
<code>through in rad</code>		<code>through in rad= center K1 angle pi/4 point B]</code>
<code>R in rad</code>		<code>R in rad = center K1 angle pi/6 radius \rAp</code>

The new order for arguments are : center, angle and point or radius.

9.2.1. Altshiller's Theorem

The two lines joining the points of intersection of two orthogonal circles to a point on one of the circles met the other circle in two diametrically opposite points. Altshiller p 176

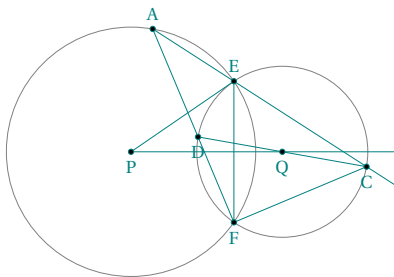

```

\begin{tikzpicture}[scale=.4]
\tkzDefPoints{0/0/P,5/0/Q,3/2/I}
\tkzDefCircle[orthogonal from=P](Q,I)
\tkzGetFirstPoint{E}
\tkzDrawCircles(P,E Q,E)
\tkzInterCC[common=E](P,E)(Q,E)\tkzGetFirstPoint{F}
\tkzDefPointOnCircle[through = center P angle 80 point E]
\tkzGetPoint{A}
\tkzInterLC[common=E](A,E)(Q,E)\tkzGetFirstPoint{C}
\tkzInterLL(A,F)(C,Q)\tkzGetPoint{D}
\tkzDrawLines[add=0 and .75](P,Q)
\tkzDrawLines[add=0 and 2](A,E)
\tkzDrawSegments(P,E E,F F,C A,F C,D)
\tkzDrawPoints(P,Q,E,F,A,C,D)
\tkzLabelPoints(P,Q,F,C,D)
\tkzLabelPoints[above](E,A)
\end{tikzpicture}

```

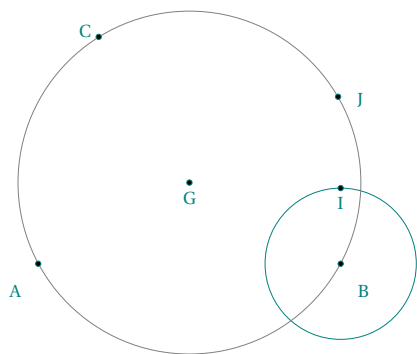
9.2.2. Use of `\tkzDefPointOnCircle`

```

\begin{tikzpicture}
\tkzDefPoints{0/0/A,4/0/B,0.8/3/C}
\tkzDefPointOnCircle[R = center B angle 90 radius 1]
\tkzGetPoint{I}
\tkzDefCircle[circum] (A,B,C)
\tkzGetPoints{G}{g}
\tkzDefPointOnCircle[through = center G angle 30 point g]
\tkzGetPoint{J}
\tkzDefCircle[R] (B,1) \tkzGetPoint{b}
\tkzDrawCircle[teal] (B,b)
\tkzDrawCircle(G,J)
\tkzDrawPoints(A,B,C,G,I,J)
\tkzAutoLabelPoints[center=G] (A,B,C,J)
\tkzLabelPoints[below] (G,I)
\end{tikzpicture}

```

10. Special points relating to a triangle

10.1. Triangle center: `\tkzDefTriangleCenter`

```
\tkzDefTriangleCenter[⟨local options⟩](⟨A,B,C⟩)
```

 This macro allows you to define the center of a triangle.. Be careful, the arguments are lists of three points. This macro is used in conjunction with `\tkzGetPoint` to get the center you are looking for. You can use `\tkzPointResult` if it is not necessary to keep the results.

arguments	default	example
(pt1,pt2,pt3)	no default	<code>\tkzDefTriangleCenter[ortho](B,C,A)</code>
options	default	definition
ortho	circum	intersection of the altitudes
orthic	circum	...
centroid	circum	intersection of the medians
median	circum	...
circum	circum	circle center circumscribed
in	circum	center of the circle inscribed in a triangle
in	circum	intersection of the bisectors
ex	circum	center of a circle exinscribed to a triangle
euler	circum	center of Euler's circle
gergonne	circum	defined with the Contact triangle
symmedian	circum	Lemoine's point or symmedian center or Grebe's point
lemoine	circum	...
grebe	circum	...
spieker	circum	Spieker circle center
nagel	circum	Nagel Center
mittenpunkt	circum	Or middlespoint
feuerbach	circum	Feuerbach Point

10.1.1. Option `ortho` or `orthic`

The intersection H of the three altitudes of a triangle is called the orthocenter.

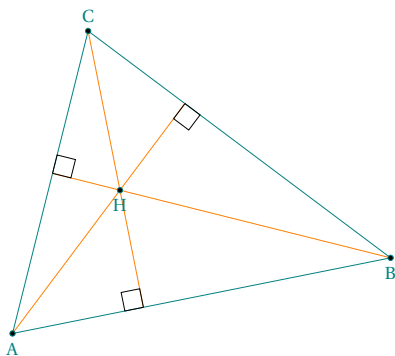

```
\begin{tikzpicture}
  \tkzDefPoint(0,0){A}
  \tkzDefPoint(5,1){B}
  \tkzDefPoint(1,4){C}
  \tkzDefTriangleCenter[ortho](B,C,A)
  \tkzGetPoint{H}
  \tkzDefSpcTriangle[orthic,name=H](A,B,C){a,b,c}
  \tkzDrawPolygon(A,B,C)
  \tkzDrawSegments[new](A,Ha B,Hb C,Hc)
  \tkzDrawPoints(A,B,C,H)
  \tkzLabelPoint(H){H}
  \tkzLabelPoints[below](A,B)
  \tkzLabelPoints[above](C)
  \tkzMarkRightAngles(A,Ha B,Hb C,Hc,A)
\end{tikzpicture}
```

10.1.2. Option centroid

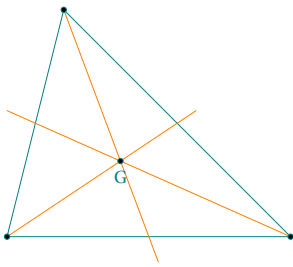

```
\begin{tikzpicture}[scale=.75]
  \tkzDefPoints{0/0/A,5/0/B,1/4/C}
  \tkzDefTriangleCenter[centroid](A,B,C)
  \tkzGetPoint{G}
  \tkzDrawPolygon(A,B,C)
  \tkzDrawLines[add = 0 and 2/3,new](A,G B,G C,G)
  \tkzDrawPoints(A,B,C,G)
  \tkzLabelPoint(G){G}
\end{tikzpicture}
```

10.1.3. Option circum

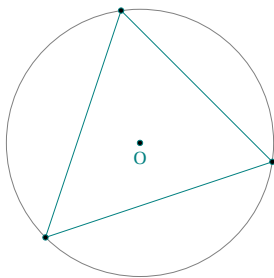

```
\begin{tikzpicture}
  \tkzDefPoints{0/1/A,3/2/B,1/4/C}
  \tkzDefTriangleCenter[circum](A,B,C)
  \tkzGetPoint{O}
  \tkzDrawPolygon(A,B,C)
  \tkzDrawCircle(O,A)
  \tkzDrawPoints(A,B,C,O)
  \tkzLabelPoint(O){O}
\end{tikzpicture}
```

10.1.4. Option in

In geometry, the incircle or inscribed circle of a triangle is the largest circle contained in the triangle; it touches (is tangent to) the three sides. The center of the incircle is a triangle center called the triangle's incenter. The center of the incircle, called the incenter, can be found as the intersection of the three internal angle bisectors. The center of an excircle is the intersection of the internal bisector of one angle (at vertex A, for example) and the external bisectors of the other two. The center of this excircle is called the excenter relative to the vertex A, or the excenter of A. Because the internal bisector of an angle is perpendicular to its external bisector, it follows that the center of the incircle together with the three excircle centers form an orthocentric system.

(Article on [Wikipedia](#))

We get the center of the inscribed circle of the triangle. The result is of course in `tkzPointResult`. We can retrieve it with `\tkzGetPoint`.

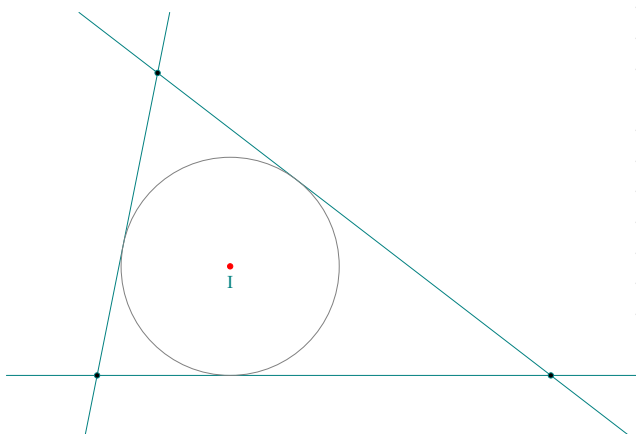

```
\begin{tikzpicture}
  \tkzDefPoints{0/0/A,6/0/B,0.8/4/C}
  \tkzDefTriangleCenter[in](A,B,C)
  \tkzGetPoint{I}
  \tkzDrawLines(A,B B,C C,A)
  \tkzDefCircle[in](A,B,C) \tkzGetPoints{I}{i}
  \tkzDrawCircle(I,i)
  \tkzDrawPoint[red](I)
  \tkzDrawPoints(A,B,C)
  \tkzLabelPoint(I){I}
\end{tikzpicture}
```

10.1.5. Option ex

An excircle or escribed circle of the triangle is a circle lying outside the triangle, tangent to one of its sides and tangent to the extensions of the other two. Every triangle has three distinct excircles, each tangent to one of the

triangle's sides.

(Article on [Wikipedia](#))

We get the center of an inscribed circle of the triangle. The result is of course in `tkzPointResult`. We can retrieve it with `\tkzGetPoint`.

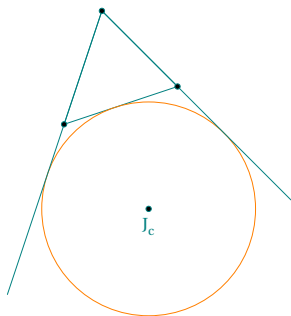

```
\begin{tikzpicture}[scale=.5]
  \tkzDefPoints{0/1/A,3/2/B,1/4/C}
  \tkzDefTriangleCenter[ex](B,C,A)
  \tkzGetPoint{J_c}
  \tkzDefPointBy[projection=onto A--B](J_c)
  \tkzGetPoint{Tc}
  \tkzDrawPolygon(A,B,C)
  \tkzDrawCircle[new](J_c,Tc)
  \tkzDrawLines[add=1.5 and 0](A,C B,C)
  \tkzDrawPoints(A,B,C,J_c)
  \tkzLabelPoints(J_c)
\end{tikzpicture}
```

10.1.6. Option euler

This macro allows to obtain the center of the circle of the nine points or Euler's circle or Feuerbach's circle. The nine-point circle, also called Euler's circle or the Feuerbach circle, is the circle that passes through the perpendicular feet H_A , H_B , and H_C dropped from the vertices of any reference triangle ABC on the sides opposite them. Euler showed in 1765 that it also passes through the midpoints M_A , M_B , M_C of the sides of ABC . By Feuerbach's theorem, the nine-point circle also passes through the midpoints E_A , E_B , and E_C of the segments that join the vertices and the orthocenter H . These points are commonly referred to as the Euler points.

(<https://mathworld.wolfram.com/Nine-PointCircle.html>)

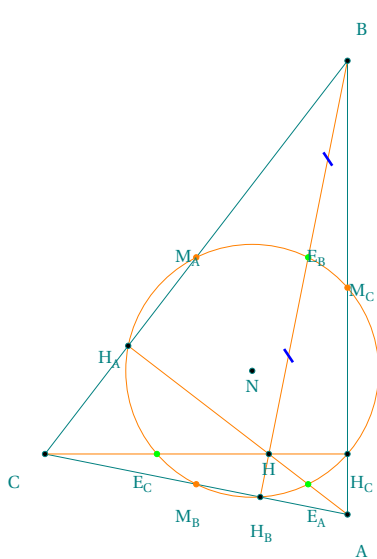

```
\begin{tikzpicture}[scale=1,rotate=90]
  \tkzDefPoints{0/0/A,6/0/B,0.8/4/C}
  \tkzDefSpcTriangle[medial,name=M](A,B,C){_A,_B,_C}
  \tkzDefTriangleCenter[euler](A,B,C)\tkzGetPoint{N}
  % I= N nine points
  \tkzDefTriangleCenter[ortho](A,B,C)\tkzGetPoint{H}
  \tkzDefMidPoint(A,H)\tkzGetPoint{E_A}
  \tkzDefMidPoint(C,H)\tkzGetPoint{E_C}
  \tkzDefMidPoint(B,H)\tkzGetPoint{E_B}
  \tkzDefSpcTriangle[ortho,name=H](A,B,C){_A,_B,_C}
  \tkzDrawPolygon(A,B,C)
  \tkzDrawCircle[new](N,E_A)
  \tkzDrawSegments[new](A,H_A B,H_B C,H_C)
  \tkzDrawPoints(A,B,C,N,H)
  \tkzDrawPoints[new](M_A,M_B,M_C)
  \tkzDrawPoints(H_A,H_B,H_C)
  \tkzDrawPoints[green](E_A,E_B,E_C)
  \tkzAutoLabelPoints[center=N,
font=\scriptsize](A,B,C,M_A,M_B,M_C,H_A,H_B,H_C,E_A,E_B,E_C)
  \tkzLabelPoints[font=\scriptsize](H,N)
  \tkzMarkSegments[mark=s|,size=3pt,
color=blue,line width=1pt](B,E_B E_B,H)
\end{tikzpicture}
```

10.1.7. Option symmedian

The point of concurrence K of the symmedians, sometimes also called the Lemoine point (in England and France) or the Grebe point (in Germany).

Weisstein, Eric W. "Symmedian Point." From [MathWorld—A Wolfram Web Resource](#).

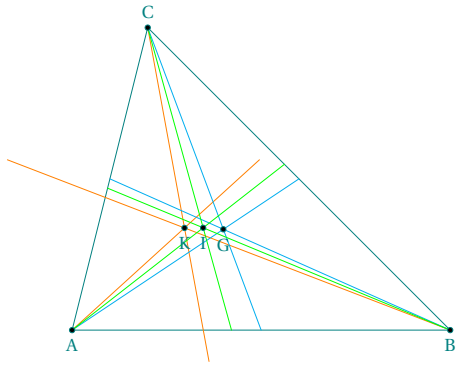

```

\begin{tikzpicture}
  \tkzDefPoint(0,0){A}
  \tkzDefPoint(5,0){B}
  \tkzDefPoint(1,4){C}
  \tkzDefTriangleCenter[symmedian](A,B,C)\tkzGetPoint{K}
  \tkzDefTriangleCenter[median](A,B,C)\tkzGetPoint{G}
  \tkzDefTriangleCenter[in](A,B,C)\tkzGetPoint{I}
  \tkzDefSpcTriangle[centroid,name=M](A,B,C){a,b,c}
  \tkzDefSpcTriangle[incentral,name=I](A,B,C){a,b,c}
  \tkzDrawPolygon(A,B,C)
  \tkzDrawLines[add = 0 and 2/3,new](A,K B,K C,K)
  \tkzDrawSegments[color=cyan](A,Ma B,Mb C,Mc)
  \tkzDrawSegments[color=green](A,Ia B,Ib C,Ic)
  \tkzDrawPoints(A,B,C,K,G,I)
  \tkzLabelPoints[font=\scriptsize](A,B,K,G,I)
  \tkzLabelPoints[above,font=\scriptsize](C)
\end{tikzpicture}

```

10.1.8. Option spieker

The Spieker center is the center Sp of the Spieker circle, i.e., the incenter of the medial triangle of a reference triangle.

Weisstein, Eric W. "Spieker Center." From MathWorld—A Wolfram Web Resource.

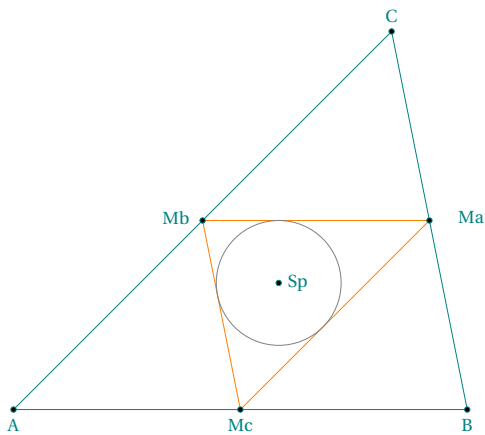

```

\begin{tikzpicture}
  \tkzDefPoints{0/0/A,6/0/B,5/5/C}
  \tkzDefSpcTriangle[medial](A,B,C){Ma,Mb,Mc}
  \tkzDefTriangleCenter[centroid](A,B,C)
  \tkzGetPoint{G}
  \tkzDefTriangleCenter[spieker](A,B,C)
  \tkzGetPoint{Sp}
  \tkzDrawPolygon[](A,B,C)
  \tkzDrawPolygon[new](Ma,Mb,Mc)
  \tkzDefCircle[in](Ma,Mb,Mc)\tkzGetPoints{I}{i}
  \tkzDrawCircle(I,i)
  \tkzDrawPoints(B,C,A,Sp,Ma,Mb,Mc)
  \tkzAutoLabelPoints[center=G,dist=.3](Ma,Mb)
  \tkzLabelPoints[right](Sp)
  \tkzLabelPoints[below](A,B,Mc)
  \tkzLabelPoints[above](C)
\end{tikzpicture}

```

10.1.9. Option gergonne

The Gergonne Point is the point of concurrency which results from connecting the vertices of a triangle to the opposite points of tangency of the triangle's incircle. (Joseph Gergonne French mathematician)

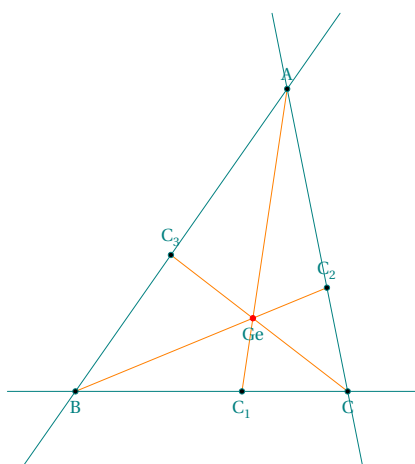

```

\begin{tikzpicture}
\tkzDefPoints{0/0/B,3.6/0/C,2.8/4/A}
\tkzDefTriangleCenter[gergonne](A,B,C)
\tkzGetPoint{Ge}
\tkzDefSpcTriangle[intouch](A,B,C){C_1,C_2,C_3}
\tkzDefCircle[in](A,B,C)\tkzGetPoints{I}{i}
\tkzDrawLines[add=.25 and .25,teal](A,B A,C B,C)
\tkzDrawSegments[new](A,C_1 B,C_2 C,C_3)
\tkzDrawPoints(A,...,C,C_1,C_2,C_3)
\tkzDrawPoints[red](Ge)
\tkzLabelPoints(B,C,C_1,Ge)
\tkzLabelPoints[above](A,C_2,C_3)
\end{tikzpicture}

```

10.1.10. Option nagel

Let T_a be the point at which the excircle with center J_a meets the side BC of a triangle ABC , and define T_b and T_c similarly. Then the lines AT_a , BT_b , and CT_c concur in the Nagel point N_a .

Weisstein, Eric W. "Nagel point." From MathWorld—A Wolfram Web Resource.

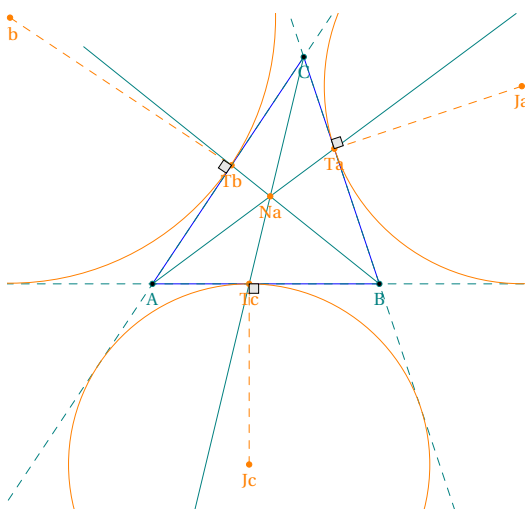

```

\begin{tikzpicture}[scale=.5]
\tkzDefPoints{0/0/A,6/0/B,4/6/C}
\tkzDefSpcTriangle[ex](A,B,C){Ja,Jb,Jc}
\tkzDefSpcTriangle[extouch](A,B,C){Ta,Tb,Tc}
\tkzDefTriangleCenter[nagel](A,B,C)
\tkzGetPoint{Na}
\tkzDrawPolygon[blue](A,B,C)
\tkzDrawLines[add=0 and 1](A,Ta B,Tb C,Tc)
\tkzDrawPoints[new](Ja,Jb,Jc,Ta,Tb,Tc)
\tkzClipBB
\tkzDrawLines[add=1 and 1,dashed](A,B B,C C,A)
\tkzDrawCircles[new](Ja,Ta Jb,Tb Jc,Tc)
\tkzDrawSegments[new,dashed](Ja,Ta Jb,Tb Jc,Tc)
\tkzDrawPoints(B,C,A)
\tkzDrawPoints[new](Na)
\tkzLabelPoints(B,C,A)
\tkzLabelPoints[new](Na)
\tkzLabelPoints[new](Ja,Jb,Jc,Ta,Tb,Tc)
\tkzMarkRightAngles[fill=gray!20](Ja,Ta,C
Jb,Tb,A Jc,Tc,B)
\end{tikzpicture}

```

10.1.11. Option mittenpunkt

The mittenpunkt (also called the middelpunkt) of a triangle ABC is the symmedian point of the excentral triangle, i.e., the point of concurrence M of the lines from the excenters through the corresponding triangle side midpoints.

Weisstein, Eric W. "Mittenpunkt." From MathWorld—A Wolfram Web Resource.

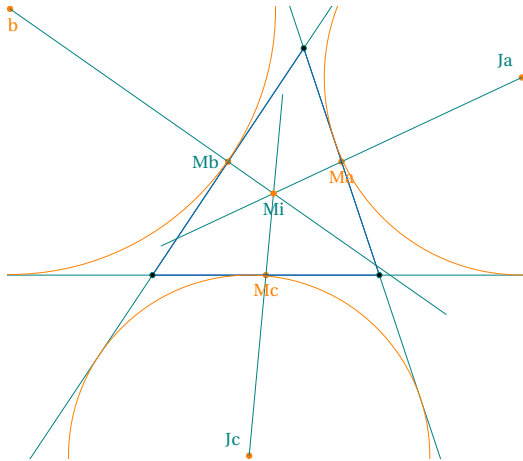

```

\begin{tikzpicture}[scale=.5]
\tkzDefPoints{0/0/A,6/0/B,4/6/C}
\tkzDefSpcTriangle[centroid](A,B,C){Ma,Mb,Mc}
\tkzDefSpcTriangle[ex](A,B,C){Ja,Jb,Jc}
\tkzDefTriangleCenter[mittelpunkt](A,B,C)
\tkzGetPoint{Mi}
\tkzDrawPoints[new](Ma,Mb,Mc,Ja,Jb,Jc)
\tkzClipBB
\tkzDrawPolygon[blue](A,B,C)
\tkzDrawLines[add=0 and 1](Ja,Ma
Jb,Mb Jc,Mc)
\tkzDrawLines[add=1 and 1](A,B A,C B,C)
\tkzDrawCircles[new](Ja,Ta Jb,Tb Jc,Tc)
\tkzDrawPoints(B,C,A)
\tkzDrawPoints[new](Mi)
\tkzLabelPoints(Mi)
\tkzLabelPoints[left](Mb)
\tkzLabelPoints[new](Ma,Mc,Jb,Jc)
\tkzLabelPoints[above left](Ja,Jc)
\end{tikzpicture}

```

10.1.12. Relation between gergonne, centroid and mittelpunkt

The Gergonne point Ge , triangle centroid G , and mittelpunkt M are collinear, with $GeG/GM=2$.

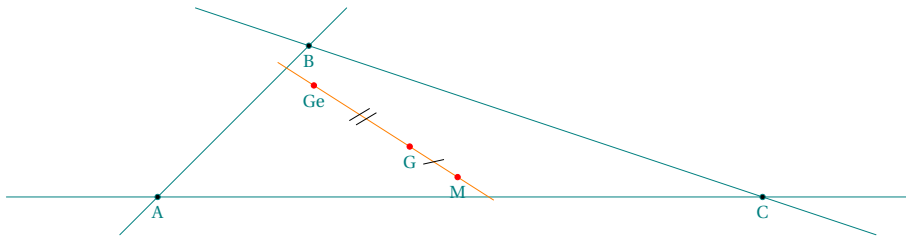

```

\begin{tikzpicture}
\tkzDefPoints{0/0/A,2/2/B,8/0/C}
\tkzDefTriangleCenter[gergonne](A,B,C) \tkzGetPoint{Ge}
\tkzDefTriangleCenter[centroid](A,B,C)
\tkzGetPoint{G}
\tkzDefTriangleCenter[mittelpunkt](A,B,C)
\tkzGetPoint{M}
\tkzDrawLines[add=.25 and .25,teal](A,B A,C B,C)
\tkzDrawLines[add=.25 and .25,new](Ge,M)
\tkzDrawPoints(A,...,C)
\tkzDrawPoints[red,size=2](G,M,Ge)
\tkzLabelPoints(A,...,C,M,G,Ge)
\tkzMarkSegment[mark=s||](Ge,G)
\tkzMarkSegment[mark=s|](G,M)
\end{tikzpicture}

```

11. Definition of points by transformation

These transformations are:

- translation;
- homothety;

- orthogonal reflection or symmetry;
- central symmetry;
- orthogonal projection;
- rotation (degrees or radians);
- inversion with respect to a circle.

11.1. `\tkzDefPointBy`

The choice of transformations is made through the options. There are two macros, one for the transformation of a single point `\tkzDefPointBy` and the other for the transformation of a list of points `\tkzDefPointsBy`. By default the image of A is A'. For example, we'll write:

```
\tkzDefPointBy[translation= from A to A'](B)
```

The result is in `tkzPointResult`

<code>\tkzDefPointBy[(local options)](<pt>)</code>		
The argument is a simple existing point and its image is stored in <code>tkzPointResult</code> . If you want to keep this point then the macro <code>\tkzGetPoint{M}</code> allows you to assign the name M to the point.		
arguments	definition	examples
pt	existing point name	(A)
options	examples	
translation	= from #1 to #2	[translation=from A to B](E)
homothety	= center #1 ratio #2	[homothety=center A ratio .5](E)
reflection	= over #1--#2	[reflection=over A--B](E)
symmetry	= center #1	[symmetry=center A](E)
projection	= onto #1--#2	[projection=onto A--B](E)
rotation	= center #1 angle #2	[rotation=center O angle 30](E)
rotation in rad	= center #1 angle #2	[rotation in rad=center O angle pi/3](E)
rotation with nodes	= center #1 from #2 to #3	[center O from A to B](E)
inversion	= center #1 through #2	[inversion =center O through A](E)
inversion negative	= center #1 through #2	...

The image is only defined and not drawn.

11.1.1. translation

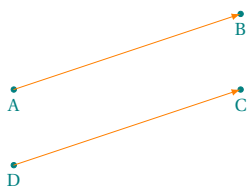

```
\begin{tikzpicture}[>=latex]
\tkzDefPoints{0/0/A,3/1/B,3/0/C}
\tkzDefPointBy[translation= from B to A](C)
\tkzGetPoint{D}
\tkzDrawPoints[teal](A,B,C,D)
\tkzLabelPoints[color=teal](A,B,C,D)
\tkzDrawSegments[orange,->](A,B D,C)
\end{tikzpicture}
```

11.1.2. reflection (orthogonal symmetry)

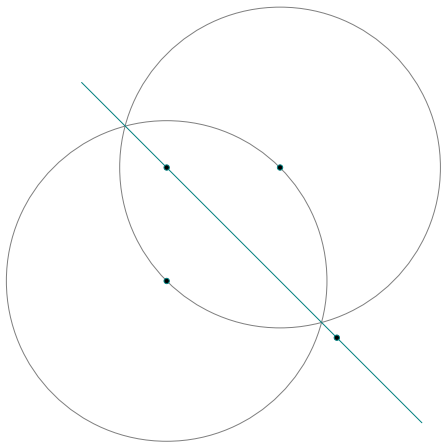

```

\begin{tikzpicture}[scale=.75]
  \tkzDefPoints{-2/-2/A,-1/-1/C,-4/2/D,-4/0/O}
  \tkzDrawCircle(O,A)
  \tkzDefPointBy[reflection = over C--D](A)
  \tkzGetPoint{A'}
  \tkzDefPointBy[reflection = over C--D](O)
  \tkzGetPoint{O'}
  \tkzDrawCircle(O',A')
  \tkzDrawLine[add= .5 and .5](C,D)
  \tkzDrawPoints(C,D,O,O')
\end{tikzpicture}

```

11.1.3. homothety and projection

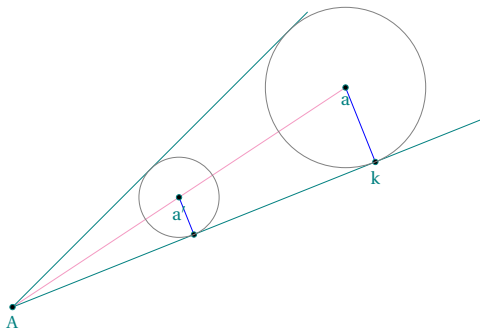

```

\begin{tikzpicture}
  \tkzDefPoints{0/1/A,5/3/B,3/4/C}
  \tkzDefLine[bisector](B,A,C) \tkzGetPoint{a}
  \tkzDrawLine[add=0 and 0,color=magenta!50](A,a)
  \tkzDefPointBy[homothety=center A ratio .5](a)
  \tkzGetPoint{a'}
  \tkzDefPointBy[projection = onto A--B](a')
  \tkzGetPoint{k'}
  \tkzDefPointBy[projection = onto A--B](a)
  \tkzGetPoint{k}
  \tkzDrawLines[add= 0 and .3](A,k A,C)
  \tkzDrawSegments[blue](a',k' a,k)
  \tkzDrawPoints(a,a',k,k',A)
  \tkzDrawCircles(a',k' a,k)
  \tkzLabelPoints(a,a',k,A)
\end{tikzpicture}

```

11.1.4. projection

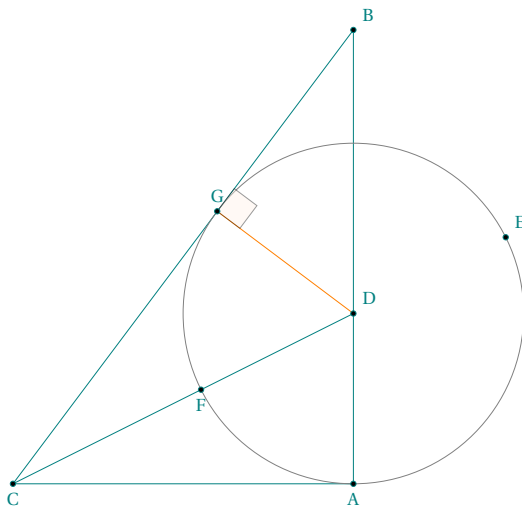

```

\begin{tikzpicture}[scale=1.5]
  \tkzDefPoints{0/0/A,0/4/B}
  \tkzDefTriangle[pythagore](B,A) \tkzGetPoint{C}
  \tkzDefLine[bisector](B,C,A) \tkzGetPoint{c}
  \tkzInterLL(C,c)(A,B) \tkzGetPoint{D}
  \tkzDefPointBy[projection=onto B--C](D)
  \tkzGetPoint{G}
  \tkzInterLC(C,D)(D,A) \tkzGetPoints{E}{F}
  \tkzDrawPolygon(A,B,C)
  \tkzDrawSegment(C,D)
  \tkzDrawCircle(D,A)
  \tkzDrawSegment[new](D,G)
  \tkzMarkRightAngle[fill=orange!10,opacity=.4](D,G,B)
  \tkzDrawPoints(A,C,F) \tkzLabelPoints(A,C,F)
  \tkzDrawPoints(B,D,E,G)
  \tkzLabelPoints[above right](B,D,E)
  \tkzLabelPoints[above](G)
\end{tikzpicture}

```

11.1.5. symmetry

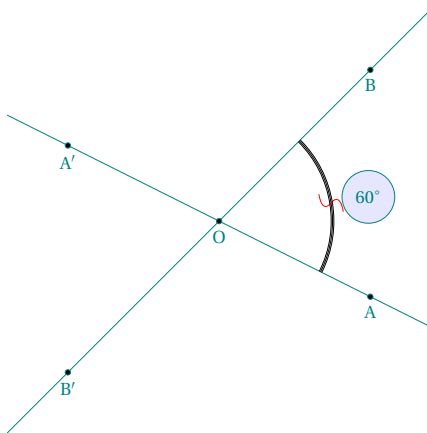

```

\begin{tikzpicture}[scale=1]
  \tkzDefPoints{2/-1/A,2/2/B,0/0/O}
  \tkzDefPointsBy[symmetry=center O](B,A){}
  \tkzDrawLine(A,A')
  \tkzDrawLine(B,B')
  \tkzMarkAngle[mark=s,arc=111,
    size=1.5,mkcolor=red](A,O,B)
  \tkzLabelAngle[pos=2,circle,draw,
    fill=blue!10,font=\scriptsize](A,O,B){$60^\circ$}
  \tkzDrawPoints(A,B,O,A',B')
  \tkzLabelPoints(B,B')
  \tkzLabelPoints[below](A,O,A')
\end{tikzpicture}

```

11.1.6. rotation

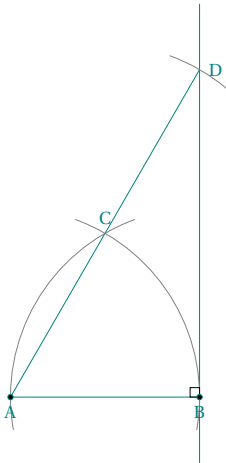

```

\begin{tikzpicture}[scale=0.5]
  \tkzDefPoints{0/0/A,5/0/B}
  \tkzDrawSegment(A,B)
  \tkzDefPointBy[rotation=center A angle 60](B)
  \tkzGetPoint{C}
  \tkzDefPointBy[symmetry=center C](A)
  \tkzGetPoint{D}
  \tkzDrawSegment(A,t kzPointResult)
  \tkzDrawLine(B,D)
  \tkzDrawArc(A,B)(C) \tkzDrawArc(B,C)(A)
  \tkzDrawArc(C,D)(D)
  \tkzMarkRightAngle(D,B,A)
  \tkzDrawPoints(A,B)
  \tkzLabelPoints(A,B)
  \tkzLabelPoints[above](C)
  \tkzLabelPoints[right](D)
\end{tikzpicture}

```

11.1.7. rotation in radian

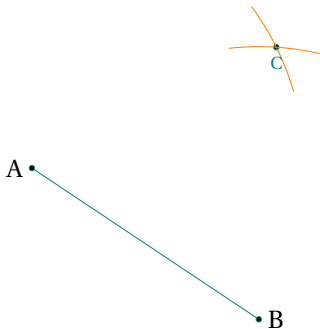

```

\begin{tikzpicture}
  \tkzDefPoint["$A$" left](1,5){A}
  \tkzDefPoint["$B$" right](4,3){B}
  \tkzDefPointBy[rotation in rad= center A angle pi/3](B)
  \tkzGetPoint{C}
  \tkzDrawSegment(A,B)
  \tkzDrawPoints(A,B,C)
  \tkzCompass(A,C)
  \tkzCompass(B,C)
  \tkzLabelPoints(C)
\end{tikzpicture}

```

11.1.8. rotation with nodes

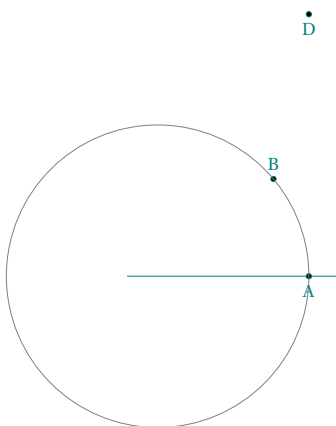

```

\begin{tikzpicture}
  \tkzDefPoint(0,0){O}
  \tkzDefPoint(0:2){A}
  \tkzDefPoint(40:2){B}
  \tkzDefPoint(20:4){C}
  \tkzDrawLine(O,A)
  \tkzDefPointBy[rotation with nodes%
    =center O from A to B](C)
  \tkzGetPoint{D}
  \tkzDrawPoints(A,B,C,D)
  \tkzDrawCircle(O,A)
  \tkzLabelPoints(A,C,D)
  \tkzLabelPoints[above](B)
\end{tikzpicture}

```

11.1.9. inversion

Inversion is the process of transforming points to a corresponding set of points known as their inverse points. Two points P and P' are said to be inverses with respect to an inversion circle having inversion center O and inversion radius k if P' is the perpendicular foot of the altitude of OQP , where Q is a point on the circle such that

OQ is perpendicular to PQ.

The quantity k^2 is known as the circle power (Coxeter 1969, p. 81). (<https://mathworld.wolfram.com/Inversion.html>)

Some propositions :

- The inverse of a circle (not through the center of inversion) is a circle.
- The inverse of a circle through the center of inversion is a line.
- The inverse of a line (not through the center of inversion) is a circle through the center of inversion.
- A circle orthogonal to the circle of inversion is its own inverse.
- A line through the center of inversion is its own inverse.
- Angles are preserved in inversion.

Explanation:

Directly (Center O power= $k^2 = OA^2 = OP \times OP'$)

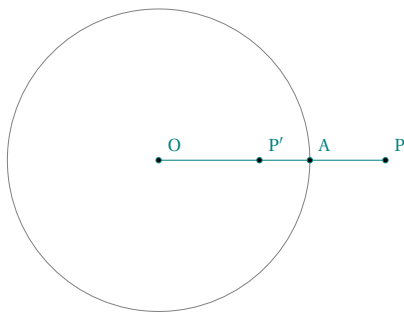

```
\begin{tikzpicture}[scale=.5]
  \tkzDefPoints{4/0/A,6/0/P,0/0/O}
  \tkzDefPointBy[inversion = center O through A](P)
  \tkzGetPoint{P'}
  \tkzDrawSegments(O,P)
  \tkzDrawCircle(O,A)
  \tkzLabelPoints[above right,font=\scriptsize](O,A,P,P')
  \tkzDrawPoints(O,A,P,P')
\end{tikzpicture}
```

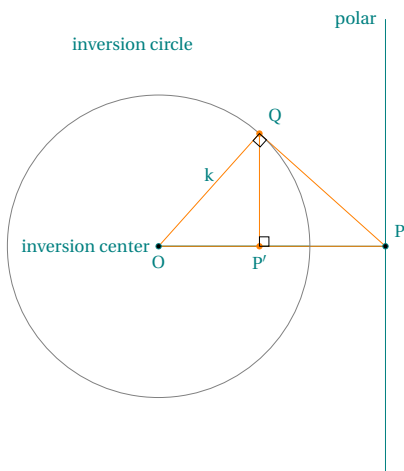

```
\begin{tikzpicture}[scale=.5]
  \tkzDefPoints{4/0/A,6/0/P,0/0/O}
  \tkzDefLine[orthogonal=through P](O,P)
  \tkzGetPoint{L}
  \tkzDefLine[tangent from = P](O,A) \tkzGetPoints{R}{Q}
  \tkzDefPointBy[projection=onto O--A](Q) \tkzGetPoint{P'}
  \tkzDrawSegments(O,P O,A)
  \tkzDrawSegments[new](O,P O,Q P,Q Q,P')
  \tkzDrawCircle(O,A)
  \tkzDrawLines[add=1 and 0](P,L)
  \tkzLabelPoints[below,font=\scriptsize](O,P')
  \tkzLabelPoints[above right,font=\scriptsize](P,Q)
  \tkzDrawPoints(O,P) \tkzDrawPoints[new](Q,P')
  \tkzLabelSegment[above](O,Q){k}
  \tkzMarkRightAngles(A,P',Q P,Q,O)
  \tkzLabelCircle[above=.5cm,
    font=\scriptsize](O,A)(100){inversion circle}
  \tkzLabelPoint[left,font=\scriptsize](O){inversion center}
  \tkzLabelPoint[left,font=\scriptsize](L){polar}
\end{tikzpicture}
```

11.1.10. Inversion of lines ex 1

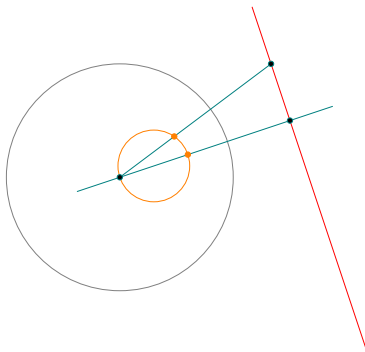

```

\begin{tikzpicture}[scale=.5]
\tkzDefPoints{O/Q/0,3/Q/I,4/3/P,6/-3/Q}
\tkzDrawCircle(O,I)
\tkzDefPointBy[projection= onto P--Q](O)\tkzGetPoint{A}
\tkzDefPointBy[inversion = center O through I](A)
\tkzGetPoint{A'}
\tkzDefPointBy[inversion = center O through I](P)
\tkzGetPoint{P'}
\tkzDefCircle[diameter](O,A')\tkzGetPoint{o}
\tkzDrawCircle[new](o,A')
\tkzDrawLines[add=.25 and .25,red](P,Q)
\tkzDrawLines[add=.25 and .25](O,A)
\tkzDrawSegments(O,P)
\tkzDrawPoints(A,P,O)\tkzDrawPoints[new](A',P')
\end{tikzpicture}

```

11.1.11. inversion of lines ex 2

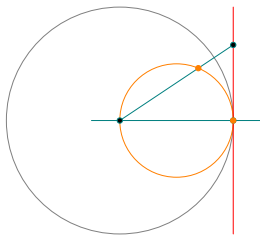

```

\begin{tikzpicture}[scale=.5]
\tkzDefPoints{O/Q/0,3/Q/I,3/2/P,3/-2/Q}
\tkzDrawCircle(O,I)
\tkzDefPointBy[projection= onto P--Q](O)\tkzGetPoint{A}
\tkzDefPointBy[inversion = center O through I](A)
\tkzGetPoint{A'}
\tkzDefPointBy[inversion = center O through I](P)
\tkzGetPoint{P'}
\tkzDefCircle[diameter](O,A')\tkzGetPoint{o}
\tkzDrawCircle[new](o,A')
\tkzDrawLines[add=.25 and .25,red](P,Q)
\tkzDrawLines[add=.25 and .25](O,A)
\tkzDrawSegments(O,P)
\tkzDrawPoints(A,P,O)\tkzDrawPoints[new](A',P')
\end{tikzpicture}

```

11.1.12. inversion of lines ex 3

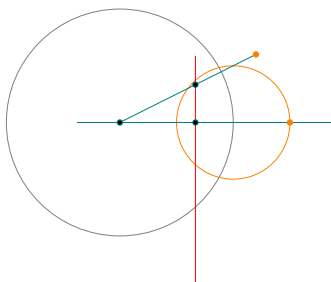

```

\begin{tikzpicture}[scale=.5]
\tkzDefPoints{O/Q/0,3/Q/I,2/1/P,2/-2/Q}
\tkzDrawCircle(O,I)
\tkzDefPointBy[projection= onto P--Q](O)\tkzGetPoint{A}
\tkzDefPointBy[inversion = center O through I](A)
\tkzGetPoint{A'}
\tkzDefPointBy[inversion = center O through I](P)
\tkzGetPoint{P'}
\tkzDefCircle[diameter](O,A')
\tkzDrawCircle[new](I,A')
\tkzDrawLines[add=.25 and .75,red](P,Q)
\tkzDrawLines[add=.25 and .25](O,A')
\tkzDrawSegments(O,P')
\tkzDrawPoints(A,P,O)\tkzDrawPoints[new](A',P')
\end{tikzpicture}

```

11.1.13. inversion of circle and homothety

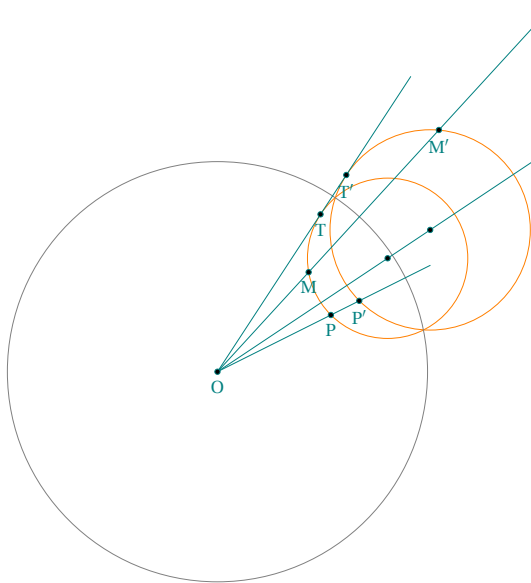

```

\begin{tikzpicture}[scale=.75]
\tkzDefPoints{0/0/0,3/2/A,2/1/P}
\tkzDefLine[tangent from = O](A,P) \tkzGetPoints{T}{X}
\tkzDefPointsBy[homothety = center O%
ratio 1.25](A,P,T){}
\tkzInterCC(A,P)(A',P') \tkzGetPoints{C}{D}
\tkzCalcLength(A,P)
\tkzGetLength{rAP}
\tkzDefPointOnCircle[R= center A angle 190 radius \rAP]
\tkzGetPoint{M}
\tkzDefPointBy[inversion = center O through C](M)
\tkzGetPoint{M'}
\tkzDrawCircles[new](A,P A',P')
\tkzDrawCircle(O,C)
\tkzDrawLines[add=0 and .5](O,T' O,A' O,M' O,P')
\tkzDrawPoints(A,A',P,P',O,T,T',M,M')
\tkzLabelPoints(O,T,T',M,M')
\tkzLabelPoints[below](P,P')
\end{tikzpicture}

```

11.1.14. inversion of Triangle with respect to the Incircle

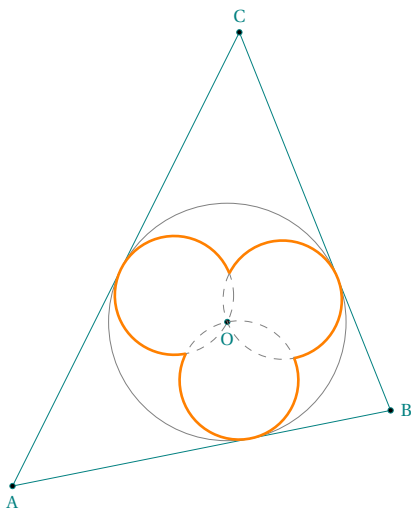

```

\begin{tikzpicture}[scale=1]
\tkzDefPoints{0/0/A,5/1/B,3/6/C}
\tkzDefTriangleCenter[in](A,B,C) \tkzGetPoint{O}
\tkzDefPointBy[projection= onto A--C](O) \tkzGetPoint{b}
\tkzDefPointBy[projection= onto A--C](O) \tkzGetPoint{c}
\tkzDefPointBy[projection= onto B--C](O) \tkzGetPoint{a}
\tkzDefPointBy[projection= onto A--B](O) \tkzGetPoint{c}
\tkzDefPointsBy[inversion = center O through b](a,b,c)%
{Ia,Ib,Ic}
\tkzDefMidPoint(O,Ia) \tkzGetPoint{Ja}
\tkzDefMidPoint(O,Ib) \tkzGetPoint{Jb}
\tkzDefMidPoint(O,Ic) \tkzGetPoint{Jc}
\tkzInterCC(Ja,O)(Jb,O) \tkzGetPoints{x}{y}
\tkzInterCC(Ja,O)(Jc,O) \tkzGetPoints{y}{z}
\tkzInterCC(Jb,O)(Jc,O) \tkzGetPoints{z}{x}
\tkzDrawPolygon(A,B,C)
\tkzDrawCircle(O,b)\tkzDrawPoints(A,B,C,O)
\tkzDrawCircles[dashed,gray](Ja,y Jb,x Jc,z)
\tkzDrawArc[line width=1pt,orange,delta=0](Jb,x)(z)
\tkzDrawArc[line width=1pt,orange,delta=0](Jc,z)(y)
\tkzDrawArc[line width=1pt,orange,delta=0](Ja,y)(x)
\tkzLabelPoint[below](A){$A$}\tkzLabelPoint[above](C){$C$}
\tkzLabelPoint[right](B){$B$}\tkzLabelPoint[below](O){$O$}
\end{tikzpicture}

```

11.1.15. inversion: orthogonal circle with inversion circle

The inversion circle itself, circles orthogonal to it, and lines through the inversion center are invariant under inversion. If the circle meets the reference circle, these invariant points of intersection are also on the inverse circle. See I and J in the next figure.

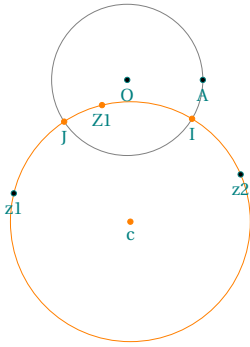

```

\begin{tikzpicture}[scale=1]
\tkzDefPoint(0,0){O}\tkzDefPoint(1,0){A}
\tkzDefPoint(-1.5,-1.5){z1}
\tkzDefPoint(1.5,-1.25){z2}
\tkzDefCircle[orthogonal through=z1 and z2](O,A)
\tkzGetPoint{c}
\tkzDrawCircle[new](c,z1)
\tkzDefPointBy[inversion = center O through A](z1)
\tkzGetPoint{Z1}
\tkzInterCC(O,A)(c,z1) \tkzGetPoints{I}{J}
\tkzDefPointBy[inversion = center O through A](I)
\tkzGetPoint{I'}
\tkzDrawCircle(O,A)
\tkzDrawPoints(O,A,z1,z2)
\tkzDrawPoints[new](c,Z1,I,J)
\tkzLabelPoints(O,A,z1,z2,c,Z1,I,J)
\end{tikzpicture}

```

For a more complex example see Pappus 45.25

11.1.16. inversion negative

It's an inversion followed by a symmetry of center O

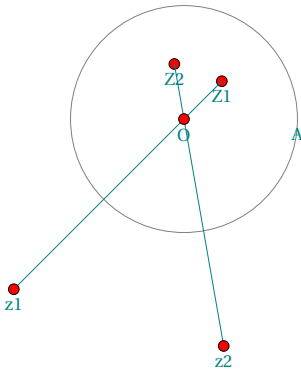

```

\begin{tikzpicture}[scale=1.5]
\tkzDefPoints{1/0/A,0/0/O}
\tkzDefPoint(-1.5,-1.5){z1}
\tkzDefPoint(0.35,-2){z2}
\tkzDefPointBy[inversion negative = center O through A](z1)
\tkzGetPoint{Z1}
\tkzDefPointBy[inversion negative = center O through A](z2)
\tkzGetPoint{Z2}
\tkzDrawCircle(O,A)
\tkzDrawPoints[color=black, fill=red,size=4](Z1,Z2)
\tkzDrawSegments(z1,Z1 z2,Z2)
\tkzDrawPoints[color=black, fill=red,size=4](O,z1,z2)
\tkzLabelPoints[font=\scriptsize](O,A,z1,z2,Z1,Z2)
\end{tikzpicture}

```

11.2. Transformation of multiple points; `\tkzDefPointsBy`

Variante of the previous macro for defining multiple images. You must give the names of the images as arguments, or indicate that the names of the images are formed from the names of the antecedents, leaving the argument empty.

```
\tkzDefPointsBy[translation= from A to A'](B,C){}
```

The images are B' and C' .

```
\tkzDefPointsBy[translation= from A to A'](B,C){D,E}
```

The images are D and E .

```
\tkzDefPointsBy[translation= from A to A'](B)
```

The image is B' .

<code>\tkzDefPointsBy[local options](list of points){list of points}</code>	
arguments	examples
<code>(list of points){list of pts}</code>	<code>(A,B){E,F}</code> E, F images of A, B
If the list of images is empty then the name of the image is the name of the antecedent to which " ' " is added.	
options	examples
<code>translation = from #1 to #2</code>	<code>[translation=from A to B] (E){}</code>
<code>homothety = center #1 ratio #2</code>	<code>[homothety=center A ratio .5] (E){F}</code>
<code>reflection = over #1--#2</code>	<code>[reflection=over A--B] (E){F}</code>
<code>symmetry = center #1</code>	<code>[symmetry=center A] (E){F}</code>
<code>projection = onto #1--#2</code>	<code>[projection=onto A--B] (E){F}</code>
<code>rotation = center #1 angle #2</code>	<code>[rotation=center angle 30] (E){F}</code>
<code>rotation in rad = center #1 angle #2</code>	for instance <code>angle pi/3</code>
<code>rotation with nodes = center #1 from #2 to #3</code>	<code>[center O from A to B] (E){F}</code>
<code>inversion = center #1 through #2</code>	<code>[inversion = center O through A] (E){F}</code>
<code>inversion negative = center #1 through #2</code>	...
The points are only defined and not drawn.	

11.2.1. translation of multiple points

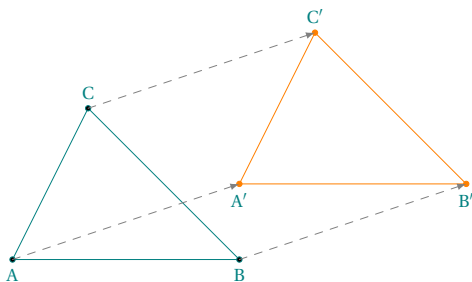

```
\begin{tikzpicture}[>=latex]
\tkzDefPoints{O/Q/A,3/Q/B,3/1/A',1/2/C}
\tkzDefPointsBy[translation= from A to A'](B,C){}
\tkzDrawPolygon(A,B,C)
\tkzDrawPolygon[new] (A',B',C')
\tkzDrawPoints(A,B,C)
\tkzDrawPoints[new] (A',B',C')
\tkzLabelPoints(A,B,A',B')
\tkzLabelPoints[above] (C,C')
\tkzDrawSegments[color = gray,->,
style=dashed](A,A' B,B' C,C')
\end{tikzpicture}
```

11.2.2. symmetry of multiple points: an oval

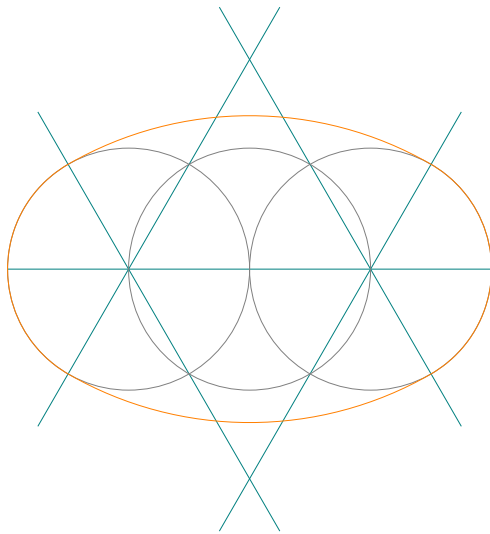

```

\begin{tikzpicture}[scale=0.4]
  \tkzDefPoint(-4,0){I}
  \tkzDefPoint(4,0){J}
  \tkzDefPoint(0,0){O}
  \tkzInterCC(J,O)(O,J) \tkzGetPoints{L}{H}
  \tkzInterCC(I,O)(O,I) \tkzGetPoints{K}{G}
  \tkzInterLL(I,K)(J,H) \tkzGetPoint{M}
  \tkzInterLL(I,G)(J,L) \tkzGetPoint{N}
  \tkzDefPointsBy[symmetry=center J](L,H){D,E}
  \tkzDefPointsBy[symmetry=center I](G,K){C,F}
  \begin{scope}[line style/.style = {very thin,teal}]
    \tkzDrawLines[add=1.5 and 1.5](I,K I,G J,H J,L)
    \tkzDrawLines[add=.5 and .5](I,J)
    \tkzDrawCircles(O,I I,O J,O)
    \tkzDrawArc[delta=0,orange](N,D)(C)
    \tkzDrawArc[delta=0,orange](M,F)(E)
    \tkzDrawArc[delta=0,orange](J,E)(D)
    \tkzDrawArc[delta=0,orange](I,C)(F)
  \end{scope}
\end{tikzpicture}

```

12. Defining points using a vector

12.1. \tkzDefPointWith

There are several possibilities to create points that meet certain vector conditions. This can be done with `\tkzDefPointWith`. The general principle is as follows, two points are passed as arguments, i.e. a vector. The different options allow to obtain a new point forming with the first point (with some exceptions) a collinear vector or a vector orthogonal to the first vector. Then the length is either proportional to that of the first one, or proportional to the unit. Since this point is only used temporarily, it does not have to be named immediately. The result is in `tkzPointResult`. The macro `\tkzGetPoint` allows you to retrieve the point and name it differently. There are options to define the distance between the given point and the obtained point. In the general case this distance is the distance between the 2 points given as arguments if the option is of the "normed" type then the distance between the given point and the obtained point is 1 cm. Then the K option allows to obtain multiples.

```
\tkzDefPointWith(<pt1,pt2>)
```

It is in fact the definition of a point meeting vectorial conditions.

arguments	definition	explanation
(pt1,pt2)	point couple	the result is a point in <code>tkzPointResult</code>

In what follows, it is assumed that the point is recovered by `\tkzGetPoint{C}`

options	example	explanation
orthogonal	[orthogonal] (A,B)	$AC = AB$ and $\overrightarrow{AC} \perp \overrightarrow{AB}$
orthogonal normed	[orthogonal normed] (A,B)	$AC = 1$ and $\overrightarrow{AC} \perp \overrightarrow{AB}$
linear	[linear] (A,B)	$\overrightarrow{AC} = K \times \overrightarrow{AB}$
linear normed	[linear normed] (A,B)	$AC = K$ and $\overrightarrow{AC} = k \times \overrightarrow{AB}$
colinear= at #1	[colinear= at C] (A,B)	$\overrightarrow{CD} = \overrightarrow{AB}$
colinear normed= at #1	[colinear normed= at C] (A,B)	$\overrightarrow{CD} = \overrightarrow{AB}$
K	[linear] (A,B),K=2	$\overrightarrow{AC} = 2 \times \overrightarrow{AB}$

12.1.1. Option colinear at, simple example

$$\overrightarrow{AB} = \overrightarrow{CD}$$

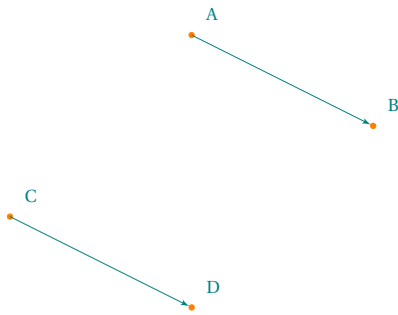

```
\begin{tikzpicture}[scale=1.2,
  vect/.style={->,shorten >=1pt,>=latex'}]
  \tkzDefPoint(2,3){A}   \tkzDefPoint(4,2){B}
  \tkzDefPoint(0,1){C}
  \tkzDefPointWith[colinear=at C](A,B)
  \tkzGetPoint{D}
  \tkzDrawPoints[new](A,B,C,D)
  \tkzLabelPoints[above right=3pt](A,B,C,D)
  \tkzDrawSegments[vect](A,B C,D)
\end{tikzpicture}
```

12.1.2. Option colinear at, complex example

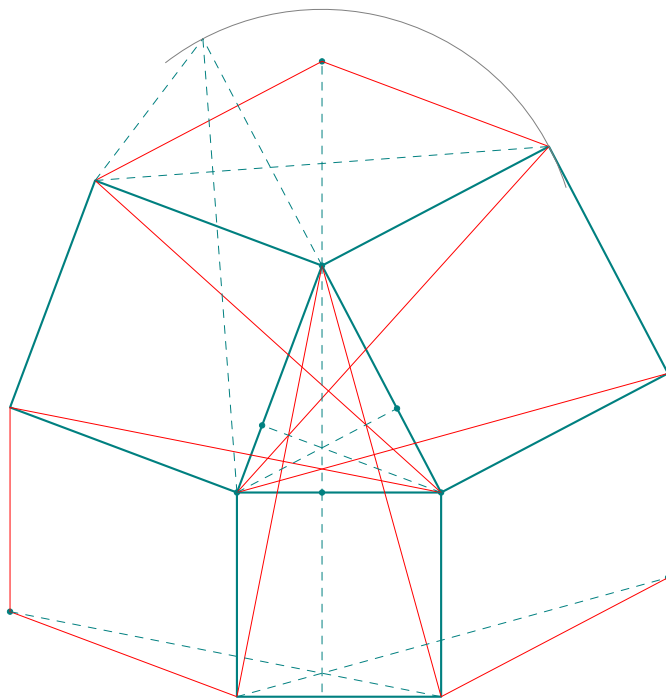

```

\begin{tikzpicture}[scale=.75]
\tkzDefPoints{0/0/B,3.6/0/C,1.5/4/A}
\tkzDefSpcTriangle[ortho](A,B,C){Ha,Hb,Hc}
\tkzDefTriangleCenter[ortho](A,B,C)\tkzGetPoint{H}
\tkzDefSquare(A,C)\tkzGetPoints{R}{S}
\tkzDefSquare(B,A)\tkzGetPoints{M}{N}
\tkzDefSquare(C,B)\tkzGetPoints{P}{Q}
\tkzDefPointWith[colinear= at M](A,S)\tkzGetPoint{A'}
\tkzDefPointWith[colinear= at P](B,N)\tkzGetPoint{B'}
\tkzDefPointWith[colinear= at Q](C,R)\tkzGetPoint{C'}
\tkzDefPointBy[projection=onto P--Q](Ha)\tkzGetPoint{Pa}
\tkzDrawPolygon[teal,thick](A,C,R,S)\tkzDrawPolygon[teal,thick](A,B,N,M)
\tkzDrawPolygon[teal,thick](C,B,P,Q)
\tkzDrawPoints[teal,size=2](A,B,C,Ha,Hb,Hc,A',B',C')
\tkzDrawSegments[ultra thin,red](M,A' A',S P,B' B',N Q,C' C',R B,S C,M C,N B,R A,P A,Q)
\tkzDrawSegments[ultra thin,teal,dashed](A,Ha B,Hb C,Hc)
\tkzDefPointBy[rotation=center A angle 90](S)\tkzGetPoint{S'}
\tkzDrawSegments[ultra thin,teal,dashed](B,S' A,S' A,A' M,S' B',Q P,C' M,S Ha,Pa)
\tkzDrawArc(A,S)(S')
\end{tikzpicture}

```

12.1.3. Option colinear at

How to use K

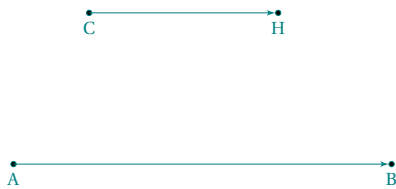

```

\begin{tikzpicture}[vect/.style={->,
shorten >=1pt,>=latex'}]
\tkzDefPoints{0/0/A,5/0/B,1/2/C}
\tkzDefPointWith[colinear=at C](A,B)
\tkzGetPoint{G}
\tkzDefPointWith[colinear=at C, K=0.5](A,B)
\tkzGetPoint{H}
\tkzLabelPoints(A,B,C,G,H)
\tkzDrawPoints(A,B,C,G,H)
\tkzDrawSegments[vect](A,B C,H)
\end{tikzpicture}

```

12.1.4. Option colinear at

With $K = \frac{\sqrt{2}}{2}$

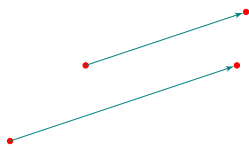

```

\begin{tikzpicture}[vect/.style={->,
shorten >=1pt,>=latex'}]
\tkzDefPoints{1/1/A,4/2/B,2/2/C}
\tkzDefPointWith[colinear=at C,K=sqrt(2)/2](A,B)
\tkzGetPoint{D}
\tkzDrawPoints[color=red](A,B,C,D)
\tkzDrawSegments[vect](A,B C,D)
\end{tikzpicture}

```

12.1.5. Option orthogonal

$AB=AC$ since $K = 1$.

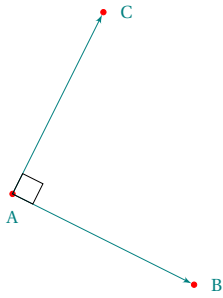

```
\begin{tikzpicture}[scale=1.2,
  vect/.style={->,shorten >=1pt,>=latex'}]
\tkzDefPoints{2/3/A,4/2/B}
\tkzDefPointWith[orthogonal,K=1](A,B)
\tkzGetPoint{C}
\tkzDrawPoints[color=red](A,B,C)
\tkzLabelPoints[right=3pt](B,C)
\tkzLabelPoints[below=3pt](A)
\tkzDrawSegments[vect](A,B A,C)
\tkzMarkRightAngle(B,A,C)
\end{tikzpicture}
```

12.1.6. Option orthogonal

With $K = -1$ $OK=OI$ since $|K| = 1$ then $OI=OJ=OK$.

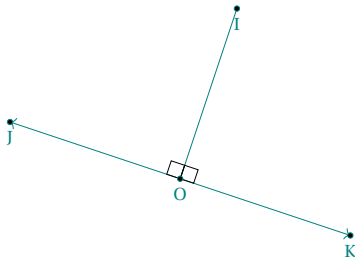

```
\begin{tikzpicture}[scale=.75]
\tkzDefPoints{1/2/0,2/5/I}
\tkzDefPointWith[orthogonal](O,I)
\tkzGetPoint{J}
\tkzDefPointWith[orthogonal,K=-1](O,I)
\tkzGetPoint{K}
\tkzDrawSegment(O,I)
\tkzDrawSegments[->](O,J O,K)
\tkzMarkRightAngles(I,O,J I,O,K)
\tkzDrawPoints(O,I,J,K)
\tkzLabelPoints(O,I,J,K)
\end{tikzpicture}
```

12.1.7. Option orthogonal more complicated example

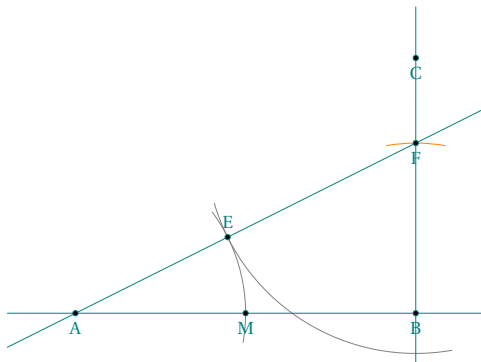

```
\begin{tikzpicture}[scale=.75]
\tkzDefPoints{0/0/A,6/0/B}
\tkzDefMidPoint(A,B)
\tkzGetPoint{I}
\tkzDefPointWith[orthogonal,K=-.75](B,A)
\tkzGetPoint{C}
\tkzInterLC(B,C)(B,I)
\tkzGetPoints{D}{F}
\tkzDuplicateSegment(B,F)(A,F)
\tkzGetPoint{E}
\tkzDrawArc[delta=10](F,E)(B)
\tkzInterLC(A,B)(A,E)
\tkzGetPoints{N}{M}
\tkzDrawArc[delta=10](A,M)(E)
\tkzDrawLines(A,B B,C A,F)
\tkzCompass(B,F)
\tkzDrawPoints(A,B,C,F,M,E)
\tkzLabelPoints(A,B,C,F,M)
\tkzLabelPoints[above](E)
\end{tikzpicture}
```

12.1.8. Options colinear and orthogonal

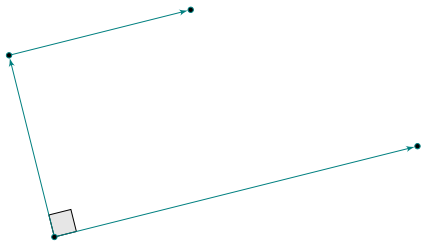

```
\begin{tikzpicture}[scale=1.2,
  vect/.style={->,shorten >=1pt,>=latex'}]
  \tkzDefPoints{2/1/A,6/2/B}
  \tkzDefPointWith[orthogonal,K=.5](A,B)
  \tkzGetPoint{C}
  \tkzDefPointWith[colinear=at C,K=.5](A,B)
  \tkzGetPoint{D}
  \tkzMarkRightAngle[fill=gray!20](B,A,C)
  \tkzDrawSegments[vect](A,B A,C C,D)
  \tkzDrawPoints(A,...,D)
\end{tikzpicture}
```

12.1.9. Option orthogonal normed

$K = 1$ $AC = 1$.

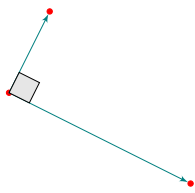

```
\begin{tikzpicture}[scale=1.2,
  vect/.style={->,shorten >=1pt,>=latex'}]
  \tkzDefPoints{2/3/A,4/2/B}
  \tkzDefPointWith[orthogonal normed](A,B)
  \tkzGetPoint{C}
  \tkzDrawPoints[color=red](A,B,C)
  \tkzDrawSegments[vect](A,B A,C)
  \tkzMarkRightAngle[fill=gray!20](B,A,C)
\end{tikzpicture}
```

12.1.10. Option orthogonal normed and $K=2$

$K = 2$ therefore $AC = 2$.

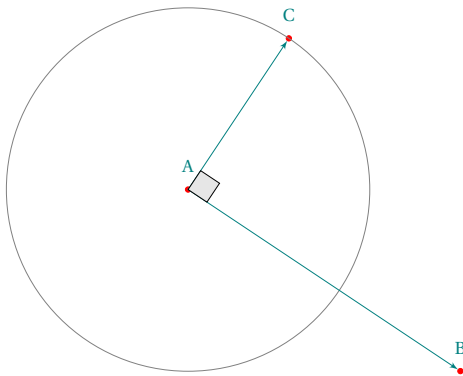

```
\begin{tikzpicture}[scale=1.2,
  vect/.style={->,shorten >=1pt,>=latex'}]
  \tkzDefPoints{2/3/A,5/1/B}
  \tkzDefPointWith[orthogonal normed,K=2](A,B)
  \tkzGetPoint{C}
  \tkzDrawPoints[color=red](A,B,C)
  \tkzDefCircle[R](A,2) \tkzGetPoint{a}
  \tkzDrawCircle(A,a)
  \tkzDrawSegments[vect](A,B A,C)
  \tkzMarkRightAngle[fill=gray!20](B,A,C)
  \tkzLabelPoints[above=3pt](A,B,C)
\end{tikzpicture}
```

12.1.11. Option linear

Here $K = 0.5$.

This amounts to applying a homothety or a multiplication of a vector by a real. Here is the middle of [AB].

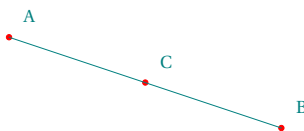

```
\begin{tikzpicture}[scale=1.2]
  \tkzDefPoints{1/3/A,4/2/B}
  \tkzDefPointWith[linear,K=0.5](A,B)
  \tkzGetPoint{C}
  \tkzDrawPoints[color=red](A,B,C)
  \tkzDrawSegment(A,B)
  \tkzLabelPoints[above right=3pt](A,B,C)
\end{tikzpicture}
```

12.1.12. Option linear normed

In the following example $AC = 1$ and C belongs to (AB) .

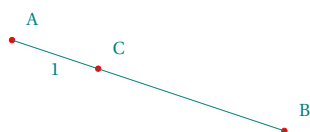

```
\begin{tikzpicture}[scale=1.2]
\tkzDefPoints{1/3/A,4/2/B}
\tkzDefPointWith[linear normed](A,B)
\tkzGetPoint{C}
\tkzDrawPoints[color=red](A,B,C)
\tkzDrawSegment(A,B)
\tkzLabelSegment(A,C){$1$}
\tkzLabelPoints[above right=3pt](A,B,C)
\end{tikzpicture}
```

12.2. \tkzGetVectxy

Retrieving the coordinates of a vector.

arguments	example	explanation
$\langle \text{point} \rangle \langle \text{name of macro} \rangle$	$\text{\tkzGetVectxy}(A,B)\{V\}$	$\backslash V_x, \backslash V_y$: coordinates of \overline{AB}

12.2.1. Coordinate transfer with \tkzGetVectxy

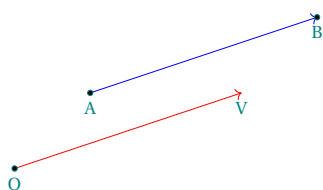

```
\begin{tikzpicture}
\tkzDefPoints{0/0/O,1/1/A,4/2/B}
\tkzGetVectxy(A,B)\{v\}
\tkzDefPoint(\vx,\vy)\{V\}
\tkzDrawSegment[->,color=red](O,V)
\tkzDrawSegment[->,color=blue](A,B)
\tkzDrawPoints(A,B,O)
\tkzLabelPoints(A,B,O,V)
\end{tikzpicture}
```

13. Straight lines

It is of course essential to draw straight lines, but before this can be done, it is necessary to be able to define certain particular lines such as mediators, bisectors, parallels or even perpendiculars. The principle is to determine two points on the straight line.

13.1. Definition of straight lines

arguments	example	explanation
$\langle \text{pt1,pt2} \rangle$	$[\text{mediator}](A,B)$	mediator of the segment $[A,B]$
$\langle \text{pt1,pt2,pt3} \rangle$	$[\text{bisector}](A,B,C)$	bisector of \widehat{ABC}
$\langle \text{pt1,pt2,pt3} \rangle$	$[\text{altitude}](A,B,C)$	altitude from B
$\langle \text{pt1} \rangle$	$[\text{tangent at=A}](O)$	tangent at A on the circle center O
$\langle \text{pt1,pt2} \rangle$	$[\text{tangent from=A}](O,B)$	circle center O through B

options	default	definition
mediator		perpendicular bisector of a line segment
perpendicular=through...	mediator	perpendicular to a straight line passing through a point
orthogonal=through...	mediator	see above
parallel=through...	mediator	parallel to a straight line passing through a point
bisector	mediator	bisector of an angle defined by three points
bisector out	mediator	exterior angle bisector
symmedian	mediator	symmedian from a vertex
altitude	mediator	altitude from a vertex
euler	mediator	euler line of a triangle
tangent at	mediator	tangent at a point of a circle
tangent from	mediator	tangent from an exterior point
K	1	coefficient for the perpendicular line
normed	false	normalizes the created segment

13.1.1. With mediator

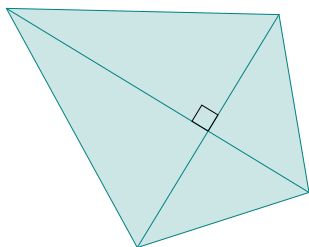

```
\begin{tikzpicture}[rotate=25]
\tkzDefPoints{-2/0/A,1/2/B}
\tkzDefLine[mediator](A,B) \tkzGetPoints{C}{D}
\tkzDefPointWith[linear,K=.75](C,D) \tkzGetPoint{D}
\tkzDefMidPoint(A,B) \tkzGetPoint{I}
\tkzFillPolygon[color=teal!20](A,C,B,D)
\tkzDrawSegments(A,B C,D)
\tkzMarkRightAngle(B,I,C)
\tkzDrawSegments(D,B D,A)
\tkzDrawSegments(C,B C,A)
\end{tikzpicture}
```

13.1.2. An envelope with option mediator

Based on a figure from O. Reboux with pst-eucl by D Rodriguez.

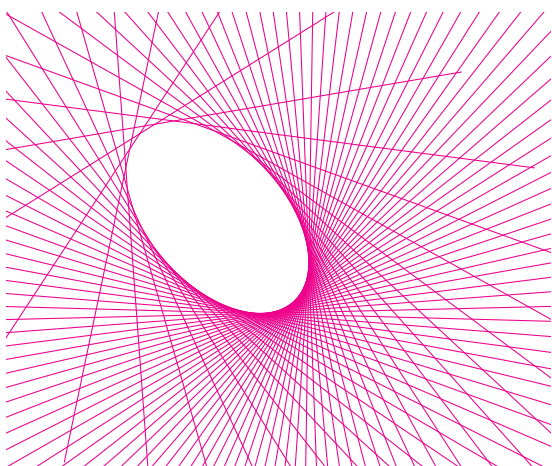

```
\begin{tikzpicture}[scale=.6]
% necessary
\tkzInit[xmin=-6,ymin=-4,xmax=6,ymax=6]
\tkzClip
\tkzSetUpLine[thin,color=magenta]
\tkzDefPoint(0,0){O}
\tkzDefPoint(132:4){A}
\tkzDefPoint(5,0){B}
\foreach \ang in {5,10,...,360}{%
\tkzDefPoint(\ang:5){M}
\tkzDefLine[mediator](A,M)
\tkzGetPoints{x}{y}
\tkzDrawLine[add= 3 and 3](x,y)}
\end{tikzpicture}
```

13.1.3. A parabola with option mediator

Based on a figure from O. Reboux with pst-eucl by D Rodriguez. It is not necessary to name the two points that define the mediator.

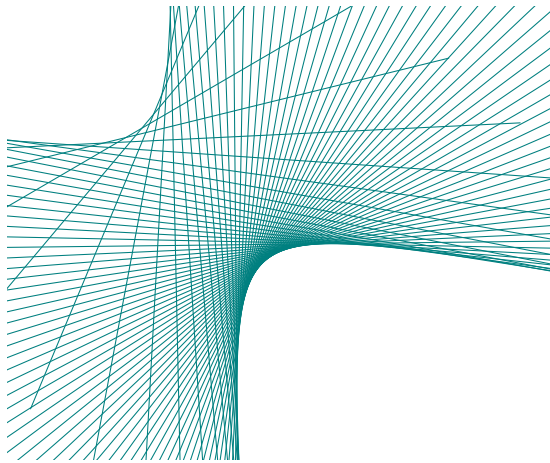

```
\begin{tikzpicture}[scale=.6]
\tkzInit[xmin=-6,ymin=-4,xmax=6,ymax=6]
\tkzClip
\tkzSetUpLine[thin,color=teal]
\tkzDefPoint(0,0){O}
\tkzDefPoint(132:5){A}
\tkzDefPoint(4,0){B}
\foreach \ang in {5,10,...,360}{%
\tkzDefPoint(\ang:4){M}
\tkzDefLine[mediator](A,M)
\tkzGetPoints{x}{y}
\tkzDrawLine[add= 3 and 3](x,y)}
\end{tikzpicture}
```

13.1.4. With options bisector and normed

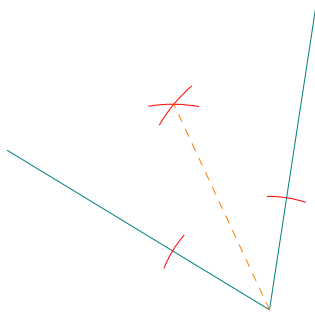

```
\begin{tikzpicture}[rotate=25,scale=.75]
\tkzDefPoints{0/0/C, 2/-3/A, 4/0/B}
\tkzDefLine[bisector,normed](B,A,C) \tkzGetPoint{a}
\tkzDrawLines[add= 0 and .5](A,B A,C)
\tkzShowLine[bisector,gap=4,size=2,color=red](B,A,C)
\tkzDrawLines[new,dashed,add= 0 and 3](A,a)
\end{tikzpicture}
```

13.1.5. With option parallel=through

Archimedes' Book of Lemmas proposition 1

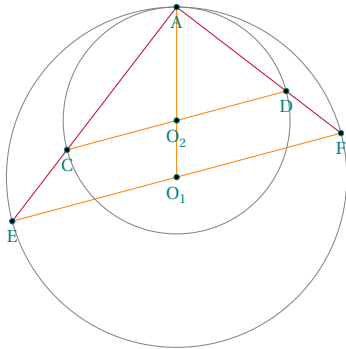

```
\begin{tikzpicture}[scale=.75]
\tkzDefPoints{0/0/O_1,0/1/O_2,0/3/A}
\tkzDefPoint(15:3){F}
\tkzInterLC(F,O_1)(O_1,A) \tkzGetSecondPoint{E}
\tkzDefLine[parallel=through O_2](E,F) \tkzGetPoint{x}
\tkzInterLC(x,O_2)(O_2,A) \tkzGetPoints{D}{C}
\tkzDrawCircles(O_1,A O_2,A)
\tkzDrawSegments[new](O_1,A E,F C,D)
\tkzDrawSegments[purple](A,E A,F)
\tkzDrawPoints(A,O_1,O_2,E,F,C,D)
\tkzLabelPoints(A,O_1,O_2,E,F,C,D)
\end{tikzpicture}
```

13.1.6. With option orthogonal and parallel

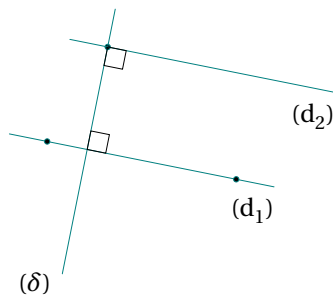

```

\begin{tikzpicture}
  \tkzDefPoints{-1.5/-0.25/A,1/-0.75/B,-0.7/1/C}
  \tkzDrawLine(A,B)
  \tkzLabelLine[pos=1.25,below left](A,B){$(d_1)$}
  \tkzDrawPoints(A,B,C)
  \tkzDefLine[orthogonal=through C](B,A) \tkzGetPoint{c}
  \tkzDrawLine(C,c)
  \tkzLabelLine[pos=1.25,left](C,c){$(\delta)$}
  \tkzInterLL(A,B)(C,c) \tkzGetPoint{I}
  \tkzMarkRightAngle(C,I,B)
  \tkzDefLine[parallel=through C](A,B) \tkzGetPoint{c'}
  \tkzDrawLine(C,c')
  \tkzLabelLine[pos=1.25,below left](C,c'){$(d_2)$}
  \tkzMarkRightAngle(I,C,c')
\end{tikzpicture}

```

13.1.7. With option altitude

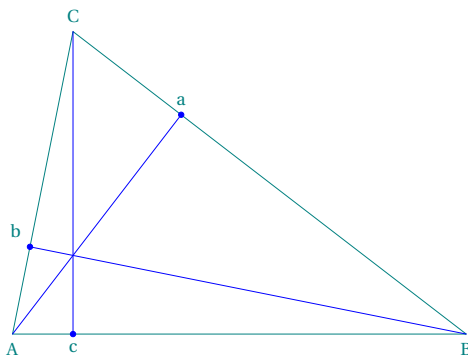

```

\begin{tikzpicture}
  \tkzDefPoints{0/0/A,6/0/B,0.8/4/C}
  \tkzDefLine[altitude](A,B,C) \tkzGetPoint{b}
  \tkzDefLine[altitude](B,C,A) \tkzGetPoint{c}
  \tkzDefLine[altitude](B,A,C) \tkzGetPoint{a}
  \tkzDrawPolygon(A,B,C)
  \tkzDrawPoints[blue](a,b,c)
  \tkzDrawSegments[blue](A,a B,b C,c)
  \tkzLabelPoints(A,B,C)
  \tkzLabelPoints[above](C,a)
  \tkzLabelPoints[above left](b)
\end{tikzpicture}

```

13.1.8. With option euler

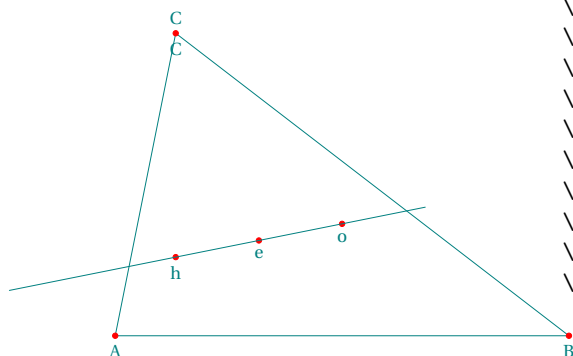

```

\begin{tikzpicture}
  \tkzDefPoints{0/0/A,6/0/B,0.8/4/C}
  \tkzDefLine[euler](A,B,C) \tkzGetPoints{h}{e}
  \tkzDefTriangleCenter[circum](A,B,C) \tkzGetPoint{o}
  \tkzDrawPolygon[teal](A,B,C)
  \tkzDrawPoints[red](A,B,C,h,e,o)
  \tkzDrawLine[add= 2 and 2](h,e)
  \tkzLabelPoints(A,B,C,h,e,o)
  \tkzLabelPoints[above](C)
\end{tikzpicture}

```

13.1.9. Tangent passing through a point on the circle tangent at

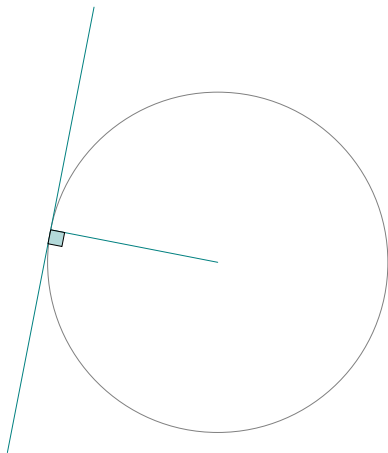

```
\begin{tikzpicture}[scale=.75]
  \tkzDefPoint(0,0){O}
  \tkzDefPoint(6,6){E}
  \tkzDefRandPointOn[ $\text{circle}=\text{center } O \text{ radius } 3$ ]
  \tkzGetPoint{A}
  \tkzDrawSegment(O,A)
  \tkzDrawCircle(O,A)
  \tkzDefLine[tangent at=A](O)
  \tkzGetPoint{h}
  \tkzDrawLine[add = 4 and 3](A,h)
  \tkzMarkRightAngle[fill=teal!30](O,A,h)
\end{tikzpicture}
```

13.1.10. Choice of contact point with tangents passing through an external point tangent from

The tangent is not drawn. With option `at`, a point of the tangent is given by `tkzPointResult`. With option `from` you get two points of the circle with `tkzFirstPointResult` and `tkzSecondPointResult`. You can choose between these two points by comparing the angles formed with the outer point, the contact point and the center. The two possible angles have different directions. Angle counterclockwise refers to `tkzFirstPointResult`.

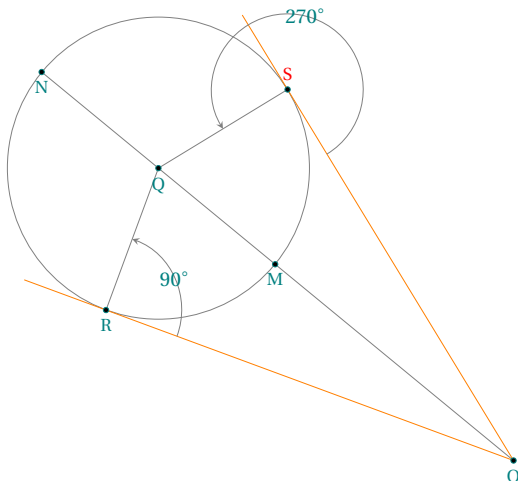

```
\begin{tikzpicture}[scale=1,rotate=-30]
  \tkzDefPoints{0/0/Q,0/2/A,6/-1/O}
  \tkzDefLine[tangent from = O](Q,A) \tkzGetPoints{R}{S}
  \tkzInterLC[near](O,Q)(Q,A) \tkzGetPoints{M}{N}
  \tkzDrawCircle(Q,M)
  \tkzDrawSegments[new,add = 0 and .2](O,R O,S)
  \tkzDrawSegments[gray](N,O R,Q S,Q)
  \tkzDrawPoints(O,Q,R,S,M,N)
  \tkzMarkAngle[gray,-stealth,size=1](O,R,Q)
  \tkzFindAngle(O,R,Q) \tkzGetAngle{an}
  \tkzLabelAngle(O,R,Q){\pgfmathprintnumber{\an}^\circ}
  \tkzMarkAngle[gray,-stealth,size=1](O,S,Q)
  \tkzFindAngle(O,S,Q) \tkzGetAngle{an}
  \tkzLabelAngle(O,S,Q){\pgfmathprintnumber{\an}^\circ}
  \tkzLabelPoints(Q,O,M,N,R)
  \tkzLabelPoints[above,text=red](S)
\end{tikzpicture}
```

13.1.11. Example of tangents passing through an external point

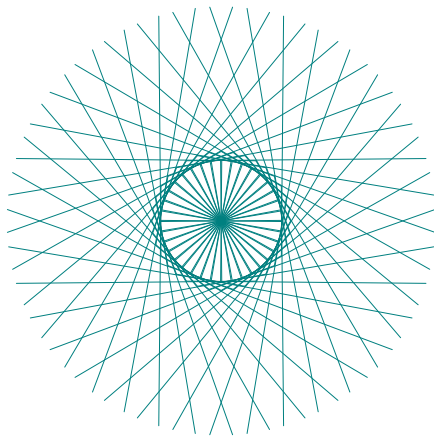

```

\begin{tikzpicture}[scale=.8]
\tkzDefPoints{0/0/c,1/0/d,3/0/a0}
\def\tkzRadius{1}
\tkzDrawCircle(c,d)
\foreach \an in {0,10,...,350}{
\tkzDefPointBy[rotation=center c angle \an](a0)
\tkzGetPoint{a}
\tkzDefLine[tangent from = a](c,d)
\tkzGetPoints{e}{f}
\tkzDrawLines(a,f a,e)
\tkzDrawSegments(c,e c,f)}
\end{tikzpicture}

```

13.1.12. Example of Andrew Mertz

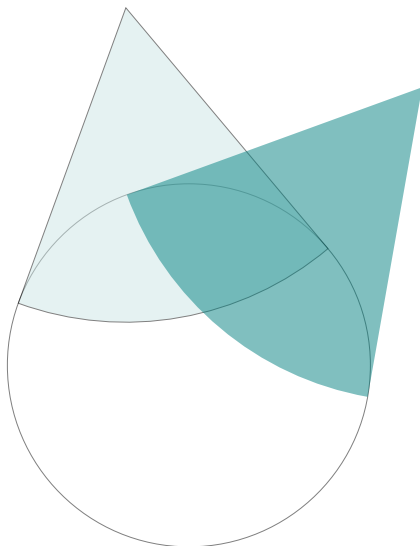

```

\begin{tikzpicture}[scale=.6]
\tkzDefPoint(100:8){A}\tkzDefPoint(50:8){B}
\tkzDefPoint(0,0){C} \tkzDefPoint(0,-4){R}
\tkzDrawCircle(C,R)
\tkzDefLine[tangent from = A](C,R) \tkzGetPoints{D}{E}
\tkzDefLine[tangent from = B](C,R) \tkzGetPoints{F}{G}
\tkzDrawSector[fill=teal!20,opacity=0.5](A,E)(D)
\tkzFillSector[color=teal,opacity=0.5](B,G)(F)
\end{tikzpicture}

```

<http://www.texample.net/tikz/examples/>

13.1.13. Drawing a tangent option tangent from

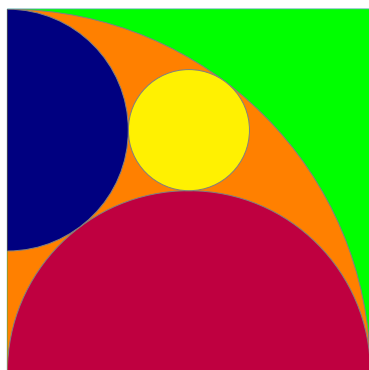

```

\begin{tikzpicture}[scale=.6]
  \tkzDefPoint(0,0){B}
  \tkzDefPoint(0,8){A}
  \tkzDefSquare(A,B)
  \tkzGetPoints{C}{D}
  \tkzDrawPolygon(A,B,C,D)
  \tkzClipPolygon(A,B,C,D)
  \tkzDefPoint(4,8){F}
  \tkzDefPoint(4,0){E}
  \tkzDefPoint(4,4){Q}
  \tkzFillPolygon[color = green](A,B,C,D)
  \tkzDrawCircle[fill = orange](B,A)
  \tkzDrawCircle[fill = purple](E,B)
  \tkzDefLine[tangent from = B](F,A)
  \tkzInterLL(F,t kzSecondPointResult)(C,D)
  \tkzInterLL(A,t kzPointResult)(F,E)
  \tkzDrawCircle[fill = yellow](tkzPointResult,Q)
  \tkzDefPointBy[projection= onto B--A](tkzPointResult)
  \tkzDrawCircle[fill = blue!50!black](tkzPointResult,A)
\end{tikzpicture}

```

14. Triangles

14.1. Definition of triangles `\tkzDefTriangle`

The following macros will allow you to define or construct a triangle from at least two points. At the moment, it is possible to define the following triangles:

- `two angles` determines a triangle with two angles;
- `equilateral` determines an equilateral triangle;
- `isosceles right` determines an isosceles right triangle;
- `half` determines a right-angled triangle such that the ratio of the measurements of the two adjacent sides to the right angle is equal to 2;
- `pythagore` determines a right-angled triangle whose side measurements are proportional to 3, 4 and 5;
- `school` determines a right-angled triangle whose angles are 30, 60 and 90 degrees;
- `golden` determines a right-angled triangle such that the ratio of the measurements on the two adjacent sides to the right angle is equal to $\Phi = 1.618034$, I chose "golden triangle" as the denomination because it comes from the golden rectangle and I kept the denomination "gold triangle" or "Euclid's triangle" for the isosceles triangle whose angles at the base are 72 degrees;
- `euclid` or `gold` for the gold triangle; in the previous version the option was "euclide" with an "e".
- `cheops` determines a third point such that the triangle is isosceles with side measurements proportional to 2, Φ and Φ .

`\tkzDefTriangle[⟨local options⟩](⟨A,B⟩)`

The points are ordered because the triangle is constructed following the direct direction of the trigonometric circle. This macro is either used in partnership with `\tkzGetPoint` or by using `tkzPointResult` if it is not necessary to keep the name.

options	default	definition
two angles= #1 and #2	no default	triangle knowing two angles
equilateral	equilateral	equilateral triangle
half	equilateral	B rectangle AB=2BC AC hypotenuse
isosceles right	equilateral	isosceles right triangle
pythagore	equilateral	proportional to the pythagorean triangle 3-4-5
pythagoras	equilateral	same as above
egyptian	equilateral	same as above
school	equilateral	angles of 30, 60 and 90 degrees
gold	equilateral	B rectangle and $AB/AC = \Phi$
euclid	equilateral	angles of 72, 72 and 36 degrees, A is the apex
golden	equilateral	angles of 72, 72 and 36 degrees, C is the apex
sublime	equilateral	angles of 72, 72 and 36 degrees, C is the apex
cheops	equilateral	AC=BC, AC and BC are proportional to 2 and Φ .
swap	false	gives the symmetric point with respect to AB

`\tkzGetPoint` allows you to store the point otherwise `tkzPointResult` allows for immediate use.

14.1.1. Option equilateral

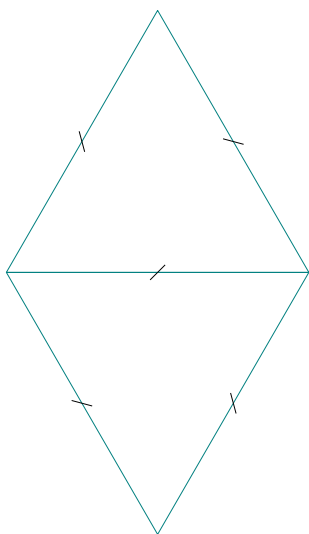

```
\begin{tikzpicture}
  \tkzDefPoint(0,0){A}
  \tkzDefPoint(4,0){B}
  \tkzDefTriangle[equilateral](A,B)
  \tkzGetPoint{C}
  \tkzDrawPolygons(A,B,C)
  \tkzDefTriangle[equilateral](B,A)
  \tkzGetPoint{D}
  \tkzDrawPolygon(B,A,D)
  \tkzMarkSegments[mark=s](A,B B,C A,C A,D B,D)
\end{tikzpicture}
```

14.1.2. Option two angles

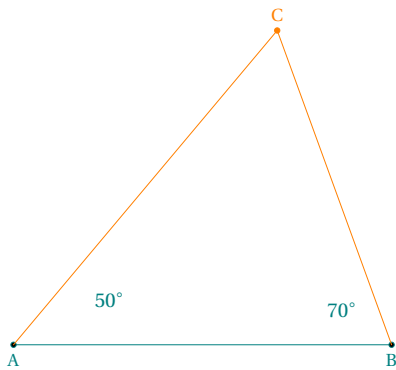

```

\begin{tikzpicture}
\tkzDefPoint(0,0){A}
\tkzDefPoint(5,0){B}
\tkzDefTriangle[two angles = 50 and 70](A,B)
\tkzGetPoint{C}
\tkzDrawSegment(A,B)
\tkzDrawPoints(A,B)
\tkzLabelPoints(A,B)
\tkzDrawSegments[new](A,C B,C)
\tkzDrawPoints[new](C)
\tkzLabelPoints[above,new](C)
\tkzLabelAngle[pos=1.4](B,A,C){$50^\circ$}
\tkzLabelAngle[pos=0.8](C,B,A){$70^\circ$}
\end{tikzpicture}

```

14.1.3. Option school

The angles are 30, 60 and 90 degrees.

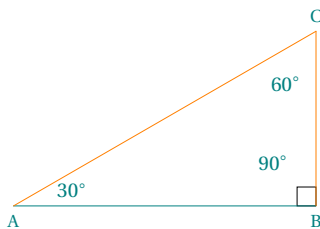

```

\begin{tikzpicture}
\tkzDefPoints{0/0/A,4/0/B}
\tkzDefTriangle[school](A,B)
\tkzGetPoint{C}
\tkzMarkRightAngles(C,B,A)
\tkzLabelAngle[pos=0.8](B,A,C){$30^\circ$}
\tkzLabelAngle[pos=0.8](C,B,A){$90^\circ$}
\tkzLabelAngle[pos=0.8](A,C,B){$60^\circ$}
\tkzDrawSegments(A,B)
\tkzDrawSegments[new](A,C B,C)
\tkzLabelPoints(A,B)
\tkzLabelPoints[above](C)
\end{tikzpicture}

```

14.1.4. Option pythagore

This triangle has sides whose lengths are proportional to 3, 4 and 5.

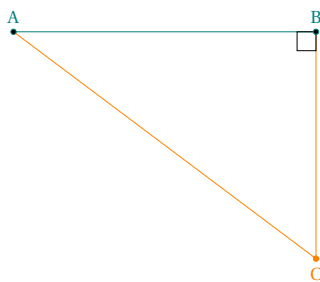

```

\begin{tikzpicture}
\tkzDefPoints{0/0/A,4/0/B}
\tkzDefTriangle[pythagore](A,B)
\tkzGetPoint{C}
\tkzDrawSegments(A,B)
\tkzDrawSegments[new](A,C B,C)
\tkzMarkRightAngles(A,B,C)
\tkzDrawPoints[new](C)
\tkzDrawPoints(A,B)
\tkzLabelPoints[above](A,B)
\tkzLabelPoints[new](C)
\end{tikzpicture}

```

14.1.5. Option pythagore and swap

This triangle has sides whose lengths are proportional to 3, 4 and 5.

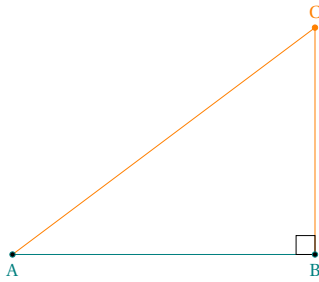

```
\begin{tikzpicture}
  \tkzDefPoints{0/0/A,4/0/B}
  \tkzDefTriangle[pythagore,swap](A,B)
  \tkzGetPoint{C}
  \tkzDrawSegments(A,B)
  \tkzDrawSegments[new](A,C B,C)
  \tkzMarkRightAngles(A,B,C)
  \tkzLabelPoint[above,new](C){C}
  \tkzDrawPoints[new](C)
  \tkzDrawPoints(A,B)
  \tkzLabelPoints(A,B)
\end{tikzpicture}
```

14.1.6. Option golden

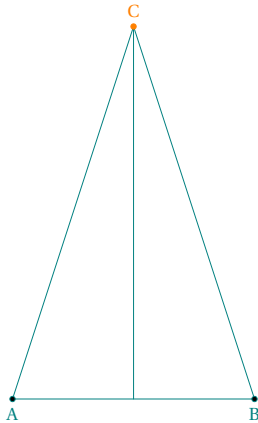

```
\begin{tikzpicture}[scale=.8]
  \tkzDefPoint(0,0){A} \tkzDefPoint(4,0){B}
  \tkzDefTriangle[golden](A,B)\tkzGetPoint{C}
  \tkzDefSpcTriangle[in,name=M](A,B,C){a,b,c}
  \tkzDrawPolygon(A,B,C)
  \tkzDrawPoints(A,B)
  \tkzDrawSegment(C,Mc)
  \tkzDrawPoints[new](C)
  \tkzLabelPoints(A,B)
  \tkzLabelPoints[above,new](C)
\end{tikzpicture}
```

14.1.7. Option euclid

Euclid and **golden** are identical but the segment AB is a base in one and a side in the other.

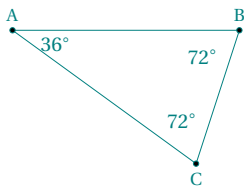

```
\begin{tikzpicture}[scale=.75]
  \tkzDefPoint(0,0){A} \tkzDefPoint(4,0){B}
  \tkzDefTriangle[euclid](A,B)\tkzGetPoint{C}
  \tkzDrawPolygon(A,B,C)
  \tkzDrawPoints(A,B,C)
  \tkzLabelPoints(C)
  \tkzLabelPoints[above](A,B)
  \tkzLabelAngle[pos=0.8](A,B,C){72^\circ}
  \tkzLabelAngle[pos=0.8](B,C,A){72^\circ}
  \tkzLabelAngle[pos=0.8](C,A,B){36^\circ}
\end{tikzpicture}
```

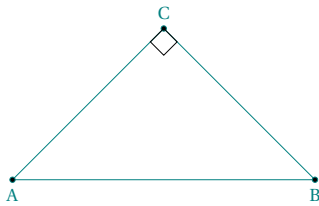
14.1.8. Option `isosceles right`

```

\begin{tikzpicture}
  \tkzDefPoint(0,0){A}
  \tkzDefPoint(4,0){B}
  \tkzDefTriangle[isosceles right](A,B)
  \tkzGetPoint{C}
  \tkzDrawPolygons(A,B,C)
  \tkzDrawPoints(A,B,C)
  \tkzMarkRightAngles(A,C,B)
  \tkzLabelPoints(A,B)
  \tkzLabelPoints[above](C)
\end{tikzpicture}

```

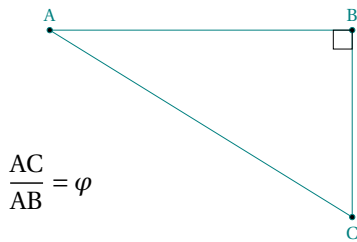
14.1.9. Option `gold`

$$\frac{AC}{AB} = \varphi$$

```

\begin{tikzpicture}
  \tkzDefPoints{0/0/A,4/0/B}
  \tkzDefTriangle[gold](A,B)
  \tkzGetPoint{C}
  \tkzDrawPolygon(A,B,C)
  \tkzDrawPoints(A,B,C)
  \tkzLabelPoints[above](A,B)
  \tkzLabelPoints[below](C)
  \tkzMarkRightAngle(A,B,C)
  \tkzText(0,-2){$\dfrac{AC}{AB}=\varphi$}
\end{tikzpicture}

```

14.2. Specific triangles with `\tkzDefSpcTriangle`

The centers of some triangles have been defined in the "points" section, here it is a question of determining the three vertices of specific triangles.

```
\tkzDefSpcTriangle[⟨local options⟩](⟨p1,p2,p3⟩){⟨r1,r2,r3⟩}
```

The order of the points is important! `p1p2p3` defines a triangle then the result is a triangle whose vertices have as reference a combination with `name` and `r1,r2,r3`. If `name` is empty then the references are `r1,r2` and `r3`.

options	default	definition
orthic	centroid	determined by endpoints of the altitudes ...
centroid or medial	centroid	intersection of the triangle's three triangle medians
in or incentral	centroid	determined with the angle bisectors
ex or excentral	centroid	determined with the excenters
extouch	centroid	formed by the points of tangency with the excircles
intouch or contact	centroid	formed by the points of tangency of the incircle each of the vertices
euler	centroid	formed by Euler points on the nine-point circle
symmedial	centroid	intersection points of the symmedians
tangential	centroid	formed by the lines tangent to the circumcircle
feuerbach	centroid	formed by the points of tangency of the nine-point ... circle with the excircles
name	empty	used to name the vertices

14.2.1. How to name the vertices

With `\tkzDefSpcTriangle[medial,name=M](A,B,C){_A,_B,_C}` you get three vertices named M_A , M_B and M_C .

With `\tkzDefSpcTriangle[medial](A,B,C){a,b,c}` you get three vertices named and labeled `a`, `b` and `c`.

Possible `\tkzDefSpcTriangle[medial,name=M_](A,B,C){A,B,C}` you get three vertices named M_A , M_B and M_C .

14.3. Option `medial` or `centroid`

The geometric centroid of the polygon vertices of a triangle is the point `G` (sometimes also denoted `M`) which is also the intersection of the triangle's three triangle medians. The point is therefore sometimes called the median point. The centroid is always in the interior of the triangle.

Weisstein, Eric W. "Centroid triangle" From MathWorld—A Wolfram Web Resource.

In the following example, we obtain the Euler circle which passes through the previously defined points.

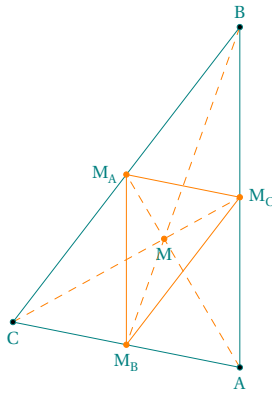

```

\begin{tikzpicture}[rotate=90,scale=.75]
\tkzDefPoints{0/0/A,6/0/B,0.8/4/C}
\tkzDefTriangleCenter[centroid](A,B,C)
\tkzGetPoint{M}
\tkzDefSpcTriangle[medial,name=M](A,B,C){_A,_B,_C}
\tkzDrawPolygon(A,B,C)
\tkzDrawSegments[dashed,new](A,M_A B,M_B C,M_C)
\tkzDrawPolygon[new](M_A,M_B,M_C)
\tkzDrawPoints(A,B,C)
\tkzDrawPoints[new](M,M_A,M_B,M_C)
\tkzLabelPoints[above](B)
\tkzLabelPoints[below](A,C,M_B)
\tkzLabelPoints[right](M_C)
\tkzLabelPoints[left](M_A)
\tkzLabelPoints[font=\scriptsize](M)
\end{tikzpicture}

```

14.3.1. Option in or incentral

The incentral triangle is the triangle whose vertices are determined by the intersections of the reference triangle's angle bisectors with the respective opposite sides.

Weisstein, Eric W. "Incentral triangle" From MathWorld—A Wolfram Web Resource.

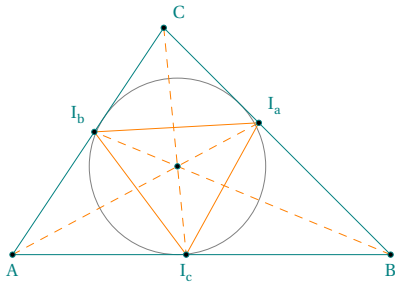

```

\begin{tikzpicture}[scale=1]
\tkzDefPoints{0/0/A,5/0/B,2/3/C}
\tkzDefSpcTriangle[in,name=I](A,B,C){_a,_b,_c}
\tkzDefCircle[in](A,B,C) \tkzGetPoints{I}{a}
\tkzDrawCircle(I,a)
\tkzDrawPolygon(A,B,C)
\tkzDrawPolygon[new](I_a,I_b,I_c)
\tkzDrawSegments[dashed,new](A,I_a B,I_b C,I_c)
\tkzDrawPoints(A,B,C,I,I_a,I_b,I_c)
\tkzLabelPoints[below](A,B,I_c)
\tkzLabelPoints[above left](I_b)
\tkzLabelPoints[above right](C,I_a)
\end{tikzpicture}

```

14.3.2. Option ex or excentral

The excentral triangle of a triangle ABC is the triangle $J_a J_b J_c$ with vertices corresponding to the excenters of ABC.

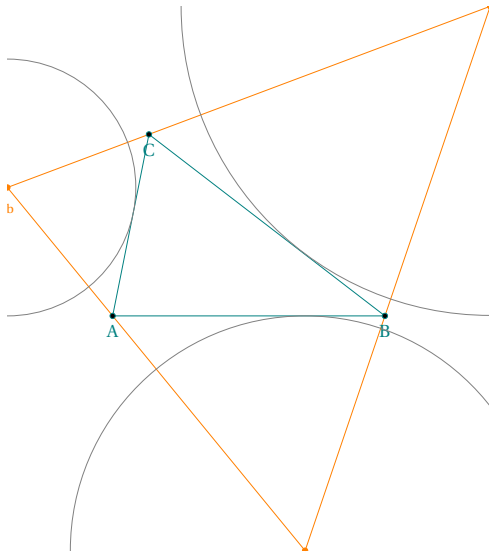

```
\begin{tikzpicture}[scale=.6]
\tkzDefPoints{0/0/A,6/0/B,0.8/4/C}
\tkzDefSpcTriangle[excentral,name=J](A,B,C){_a,_b,_c}
\tkzDefSpcTriangle[extouch,name=T](A,B,C){_a,_b,_c}
\tkzDrawPolygon(A,B,C)
\tkzDrawPolygon[new](J_a,J_b,J_c)
\tkzClipBB
\tkzDrawPoints(A,B,C)
\tkzDrawPoints[new](J_a,J_b,J_c)
\tkzLabelPoints(A,B,C)
\tkzLabelPoints[new](J_b,J_c)
\tkzLabelPoints[new,above](J_a)
\tkzDrawCircles[gray](J_a,T_a J_b,T_b J_c,T_c)
\end{tikzpicture}
```

14.3.3. Option intouch or contact

The contact triangle of a triangle ABC , also called the intouch triangle, is the triangle formed by the points of tangency of the incircle of ABC with ABC .

Weisstein, Eric W. "Contact triangle" From MathWorld—A Wolfram Web Resource.

We obtain the intersections of the bisectors with the sides.

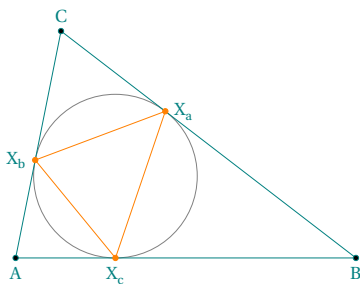

```
\begin{tikzpicture}[scale=.75]
\tkzDefPoints{0/0/A,6/0/B,0.8/4/C}
\tkzDefSpcTriangle[intouch,name=X](A,B,C){_a,_b,_c}
\tkzInCenter(A,B,C)\tkzGetPoint{I}
\tkzDefCircle[in](A,B,C)\tkzGetPoints{I}{i}
\tkzDrawCircle(I,i)
\tkzDrawPolygon(A,B,C)
\tkzDrawPolygon[new](X_a,X_b,X_c)
\tkzDrawPoints(A,B,C)
\tkzDrawPoints[new](X_a,X_b,X_c)
\tkzLabelPoints[right](X_a)
\tkzLabelPoints[left](X_b)
\tkzLabelPoints[above](C)
\tkzLabelPoints[below](A,B,X_c)
\end{tikzpicture}
```

14.3.4. Option extouch

The extouch triangle $T_aT_bT_c$ is the triangle formed by the points of tangency of a triangle ABC with its excircles J_a , J_b , and J_c . The points T_a , T_b , and T_c can also be constructed as the points which bisect the perimeter of $A_1A_2A_3$ starting at A , B , and C .

Weisstein, Eric W. "Extouch triangle" From MathWorld—A Wolfram Web Resource.

We obtain the points of contact of the exinscribed circles as well as the triangle formed by the centers of the exinscribed circles.

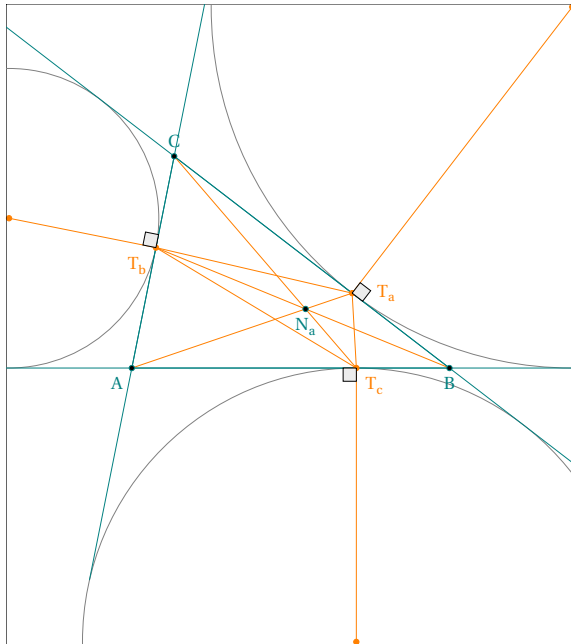

```

\begin{tikzpicture}[scale=.7]
\tkzDefPoints{0/0/A,6/0/B,0.8/4/C}
\tkzDefSpcTriangle[excentral,
  name=J](A,B,C){_a,_b,_c}
\tkzDefSpcTriangle[extouch,
  name=T](A,B,C){_a,_b,_c}
\tkzDefTriangleCenter[nagel](A,B,C)
\tkzGetPoint{N_a}
\tkzDefTriangleCenter[centroid](A,B,C)
\tkzGetPoint{G}
\tkzDrawPoints[new](J_a,J_b,J_c)
\tkzClipBB \tkzShowBB
\tkzDrawCircles[gray](J_a,T_a J_b,T_b J_c,T_c)
\tkzDrawLines[add=1 and 1](A,B B,C C,A)
\tkzDrawSegments[new](A,T_a B,T_b C,T_c)
\tkzDrawSegments[new](J_a,T_a J_b,T_b J_c,T_c)
\tkzDrawPolygon(A,B,C)
\tkzDrawPolygon[new](T_a,T_b,T_c)
\tkzDrawPoints(A,B,C,N_a)
\tkzDrawPoints[new](T_a,T_b,T_c)
\tkzLabelPoints[below left](A)
\tkzLabelPoints[below](N_a,B)
\tkzLabelPoints[above](C)
\tkzLabelPoints[new,below left](T_b)
\tkzLabelPoints[new,below right](T_c)
\tkzLabelPoints[new,right=6pt](T_a)
\tkzMarkRightAngles[fill=gray!15](J_a,T_a,B
  J_b,T_b,C J_c,T_c,A)
\end{tikzpicture}

```

14.3.5. Option orthic

Given a triangle ABC , the triangle $H_A H_B H_C$ whose vertices are endpoints of the altitudes from each of the vertices of ABC is called the orthic triangle, or sometimes the altitude triangle. The three lines AH_A , BH_B , and CH_C are concurrent at the orthocenter H of ABC .

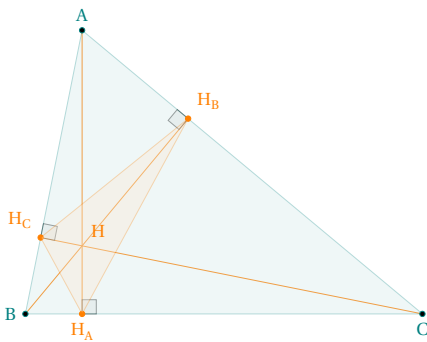

```

\begin{tikzpicture}[scale=.75]
\tkzDefPoints{1/5/A,0/0/B,7/0/C}
\tkzDefSpcTriangle[orthic](A,B,C){H_A,H_B,H_C}
\tkzDefTriangleCenter[ortho](B,C,A)
\tkzGetPoint{H}
\tkzDefPointWith[orthogonal,normed](H_A,B)
\tkzGetPoint{a}
\tkzDrawSegments[new](A,H_A B,H_B C,H_C)
\tkzMarkRightAngles[fill=gray!20,
  opacity=.5](A,H_A,C B,H_B,A C,H_C,A)
\tkzDrawPolygon[fill=teal!20,opacity=.3](A,B,C)
\tkzDrawPoints(A,B,C)
\tkzDrawPoints[new](H_A,H_B,H_C)
\tkzDrawPolygon[new,fill=orange!20,
  opacity=.3](H_A,H_B,H_C)
\tkzLabelPoints(C)
\tkzLabelPoints[left](B)
\tkzLabelPoints[above](A)
\tkzLabelPoints[new](H_A)
\tkzLabelPoints[new,above left](H_C)
\tkzLabelPoints[new,above right](H_B,H)
\end{tikzpicture}

```

14.3.6. Option feuerbach

The Feuerbach triangle is the triangle formed by the three points of tangency of the nine-point circle with the excircles.

Weisstein, Eric W. "Feuerbach triangle" From MathWorld—A Wolfram Web Resource.

The points of tangency define the Feuerbach triangle.

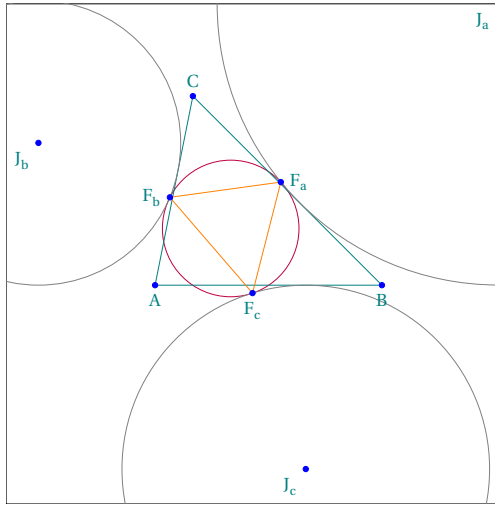

```
\begin{tikzpicture}[scale=1]
  \tkzDefPoint(0,0){A}
  \tkzDefPoint(3,0){B}
  \tkzDefPoint(0.5,2.5){C}
  \tkzDefCircle[euler](A,B,C) \tkzGetPoint{N}
  \tkzDefSpcTriangle[feuerbach,
    name=F](A,B,C){_a,_b,_c}
  \tkzDefSpcTriangle[excentral,
    name=J](A,B,C){_a,_b,_c}
  \tkzDefSpcTriangle[extouch,
    name=T](A,B,C){_a,_b,_c}
  \tkzLabelPoints[below left](J_a,J_b,J_c)
  \tkzClipBB \tkzShowBB
  \tkzDrawCircle[purple](N,F_a)
  \tkzDrawPolygon(A,B,C)
  \tkzDrawPolygon[new](F_a,F_b,F_c)
  \tkzDrawCircles[gray](J_a,F_a J_b,F_b J_c,F_c)
  \tkzDrawPoints[blue](J_a,J_b,J_c,%
    F_a,F_b,F_c,A,B,C)
  \tkzLabelPoints(A,B,F_c)
  \tkzLabelPoints[above](C)
  \tkzLabelPoints[right](F_a)
  \tkzLabelPoints[left](F_b)
\end{tikzpicture}
```

14.3.7. Option tangential

The tangential triangle is the triangle $T_a T_b T_c$ formed by the lines tangent to the circumcircle of a given triangle ABC at its vertices. It is therefore antipedal triangle of ABC with respect to the circumcenter O .

Weisstein, Eric W. "Tangential Triangle." From MathWorld—A Wolfram Web Resource.

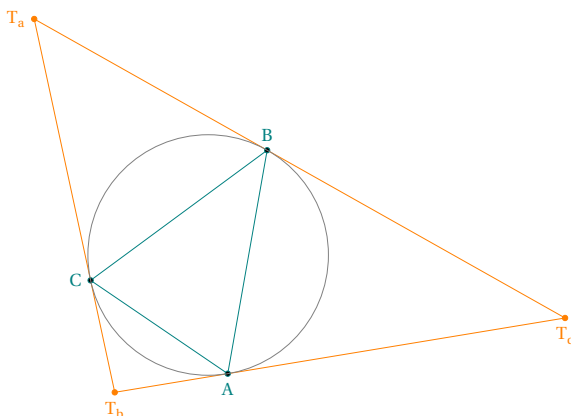

```
\begin{tikzpicture}[scale=.5,rotate=80]
  \tkzDefPoints{0/0/A,6/0/B,1.8/4/C}
  \tkzDefSpcTriangle[tangential,
    name=T](A,B,C){_a,_b,_c}
  \tkzDrawPolygon(A,B,C)
  \tkzDrawPolygon[new](T_a,T_b,T_c)
  \tkzDrawPoints(A,B,C)
  \tkzDrawPoints[new](T_a,T_b,T_c)
  \tkzDefCircle[circum](A,B,C)
  \tkzGetPoint{O}
  \tkzDrawCircle(O,A)
  \tkzLabelPoints(A)
  \tkzLabelPoints[above](B)
  \tkzLabelPoints[left](C)
  \tkzLabelPoints[new](T_b,T_c)
  \tkzLabelPoints[new,left](T_a)
\end{tikzpicture}
```

14.3.8. Option euler

The Euler triangle of a triangle ABC is the triangle $E_A E_B E_C$ whose vertices are the midpoints of the segments joining the orthocenter H with the respective vertices. The vertices of the triangle are known as the Euler points, and lie on the nine-point circle.

Weisstein, Eric W. "Euler Triangle." From MathWorld—A Wolfram Web Resource.

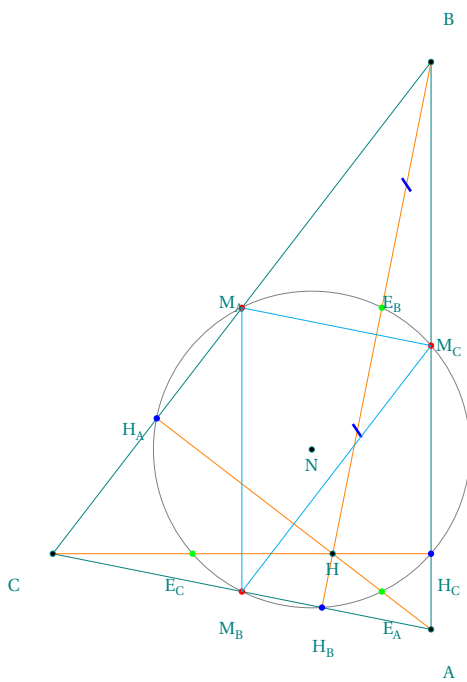

```
\begin{tikzpicture}[rotate=90,scale=1.25]
\tkzDefPoints{0/0/A,6/0/B,0.8/4/C}
\tkzDefSpcTriangle[medial,
name=M](A,B,C){_A,_B,_C}
\tkzDefTriangleCenter[euler](A,B,C)
\tkzGetPoint{N} % I= N nine points
\tkzDefTriangleCenter[ortho](A,B,C)
\tkzGetPoint{H}
\tkzDefMidPoint(A,H) \tkzGetPoint{E_A}
\tkzDefMidPoint(C,H) \tkzGetPoint{E_C}
\tkzDefMidPoint(B,H) \tkzGetPoint{E_B}
\tkzDefSpcTriangle[ortho,name=H](A,B,C){_A,_B,_C}
\tkzDrawPolygon(A,B,C)
\tkzDrawCircle(N,E_A)
\tkzDrawSegments[new](A,H_A B,H_B C,H_C)
\tkzDrawPoints(A,B,C,N,H)
\tkzDrawPoints[red](M_A,M_B,M_C)
\tkzDrawPoints[blue](H_A,H_B,H_C)
\tkzDrawPoints[green](E_A,E_B,E_C)
\tkzAutoLabelPoints[center=N,font=\scriptsize]%
(A,B,C,M_A,M_B,M_C,H_A,H_B,H_C,E_A,E_B,E_C)
\tkzLabelPoints[font=\scriptsize](H,N)
\tkzMarkSegments[mark=s|,size=3pt,
color=blue,line width=1pt](B,E_B E_B,H)
\tkzDrawPolygon[color=cyan](M_A,M_B,M_C)
\end{tikzpicture}
```

14.3.9. Option euler and Option orthic

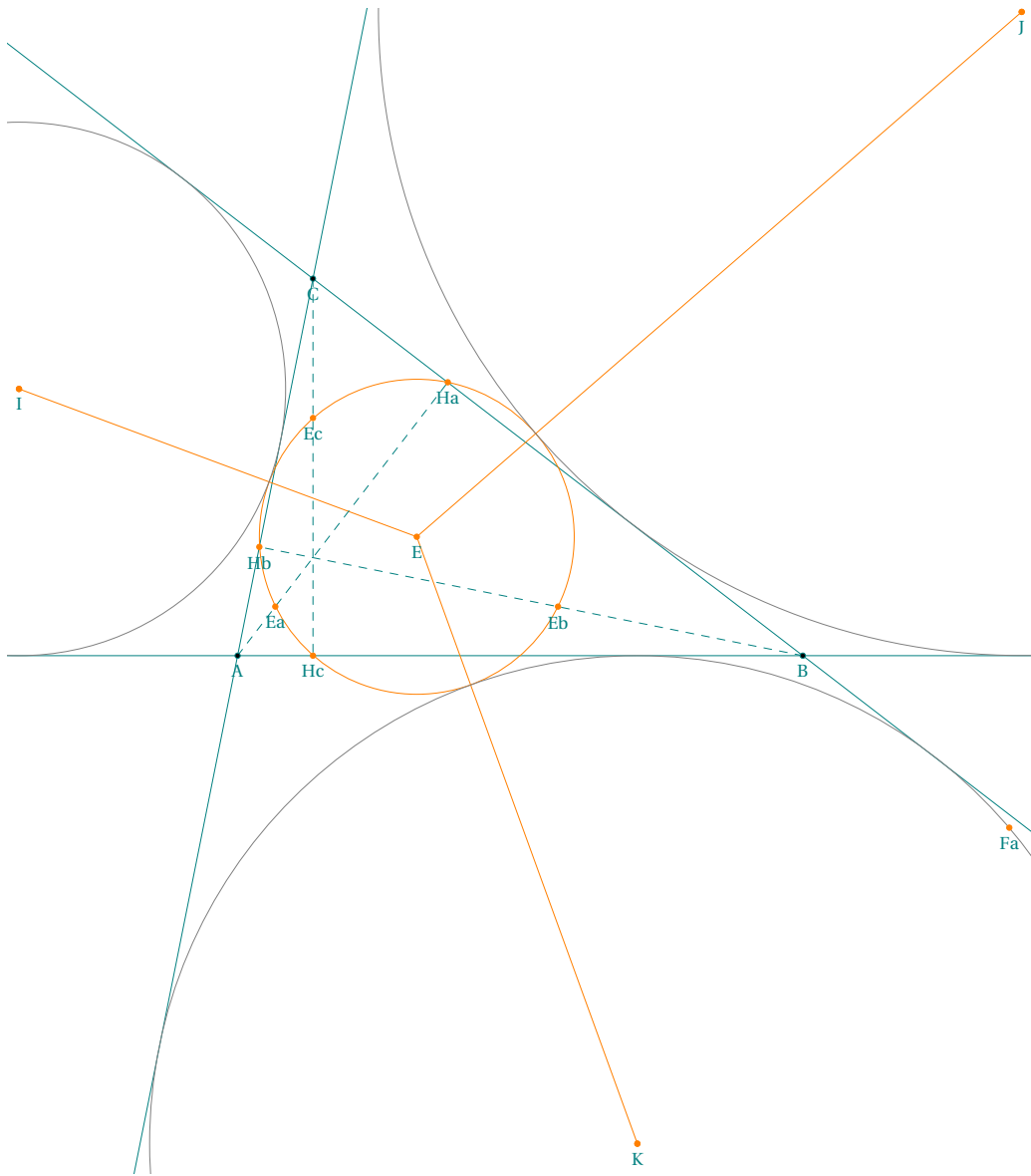

```

\begin{tikzpicture}[scale=1.25]
\tkzDefPoints{0/0/A,6/0/B,0.8/4/C}
\tkzDefSpcTriangle[euler,name=E](A,B,C){a,b,c}
\tkzDefSpcTriangle[orthic,name=H](A,B,C){a,b,c}
\tkzDefExCircle(A,B,C)\tkzGetPoints{I}{i}
\tkzDefExCircle(C,A,B)\tkzGetPoints{J}{j}
\tkzDefExCircle(B,C,A)\tkzGetPoints{K}{k}
\tkzDrawPoints[orange](I,J,K)
\tkzLabelPoints[font=\scriptsize](A,B,C,I,J,K)
\tkzClipBB
\tkzInterLC(I,C)(I,i)\tkzGetSecondPoint{Fc}
\tkzInterLC(J,B)(J,j)\tkzGetSecondPoint{Fb}
\tkzInterLC(K,A)(K,k)\tkzGetSecondPoint{Fa}
\tkzDrawLines[add=1.5 and 1.5](A,B A,C B,C)
\tkzDefCircle[euler](A,B,C)\tkzGetPoints{E}{e}
\tkzDrawCircle[orange](E,e)
\tkzDrawSegments[orange](E,I E,J E,K)
\tkzDrawSegments[dashed](A,Ha B,Hb C,Hc)
\tkzDrawCircles(J,j I,i K,k)
\tkzDrawPoints(A,B,C)
\tkzDrawPoints[orange](E,I,J,K,Ha,Hb,Hc,Ea,Eb,Ec,Fa,Fb,Fc)
\tkzLabelPoints[font=\scriptsize](E,Ea,Eb,Ec,Ha,Hb,Hc,Fa,Fb,Fc)
\end{tikzpicture}

```

14.3.10. Option symmedial

The symmedial triangle $K_A K_B K_C$ is the triangle whose vertices are the intersection points of the symmedians with the reference triangle ABC .

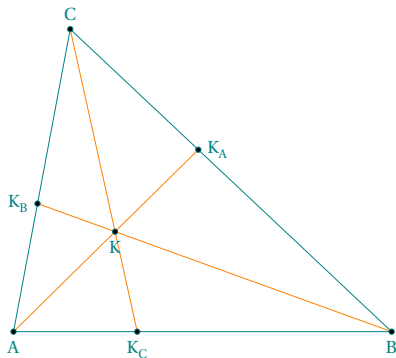

```

\begin{tikzpicture}
\tkzDefPoint(0,0){A}
\tkzDefPoint(5,0){B}
\tkzDefPoint(.75,4){C}
\tkzDefTriangleCenter[symmedial](A,B,C)\tkzGetPoint{K}
\tkzDefSpcTriangle[symmedial,name=K_](A,B,C){A,B,C}
\tkzDrawPolygon(A,B,C)
\tkzDrawSegments[new](A,K_A B,K_B C,K_C)
\tkzDrawPoints(A,B,C,K,K_A,K_B,K_C)
\tkzLabelPoints(A,B,K,K_C)
\tkzLabelPoints[above](C)
\tkzLabelPoints[right](K_A)
\tkzLabelPoints[left](K_B)
\end{tikzpicture}

```

14.4. Permutation of two points of a triangle

<code>\tkzPermute(<pt1,pt2,pt3>)</code>		
arguments	example	explanation
<code>(pt1,pt2,pt3)</code>	<code>\tkzPermute(A,B,C)</code>	$A, \widehat{B,A,C}$ are unchanged, B, C exchange their position
<i>The triangle is unchanged.</i>		

14.4.1. Modification of the school triangle

This triangle is constructed from the segment $[AB]$ on $[A, x]$.

If we want the segment $[AC]$ to be on $[A, x]$, we just have to swap B and C.

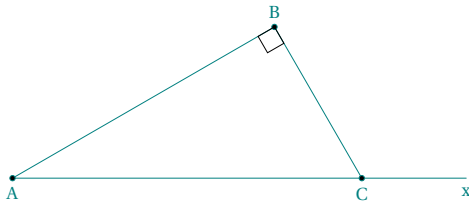

```
\begin{tikzpicture}
\tkzDefPoints{0/0/A,4/0/B,6/0/x}
\tkzDefTriangle[school](A,B)
\tkzGetPoint{C}
\tkzPermute(A,B,C)
\tkzDrawSegments(A,B C,x)
\tkzDrawSegments(A,C B,C)
\tkzDrawPoints(A,B,C)
\tkzLabelPoints(A,C,x)
\tkzLabelPoints[above](B)
\tkzMarkRightAngles(C,B,A)
\end{tikzpicture}
```

Remark: Only the first point is unchanged. The order of the last two parameters is not important.

15. Definition of polygons

15.1. Defining the points of a square

We have seen the definitions of some triangles. Let us look at the definitions of some quadrilaterals and regular polygons.

```
\tkzDefSquare(<pt1,pt2>)
```

The square is defined in the forward direction. From two points, two more points are obtained such that the four taken in order form a square. The square is defined in the forward direction.

The results are in `tkzFirstPointResult` and `tkzSecondPointResult`.

We can rename them with `\tkzGetPoints`.

Arguments	example	explanation
<code><pt1,pt2></code>	<code>\tkzDefSquare(<A,B>)</code>	The square is defined in the direct direction.

15.1.1. Using `\tkzDefSquare` with two points

Note the inversion of the first two points and the result.

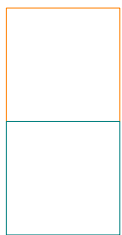

```
\begin{tikzpicture}[scale=.5]
\tkzDefPoint(0,0){A} \tkzDefPoint(3,0){B}
\tkzDefSquare(A,B)
\tkzDrawPolygon[new](A,B,tkzFirstPointResult,%
tkzSecondPointResult)
\tkzDefSquare(B,A)
\tkzDrawPolygon(B,A,tkzFirstPointResult,%
tkzSecondPointResult)
\end{tikzpicture}
```

We may only need one point to draw an isosceles right-angled triangle so we use `\tkzGetFirstPoint` or `\tkzGetSecondPoint`.

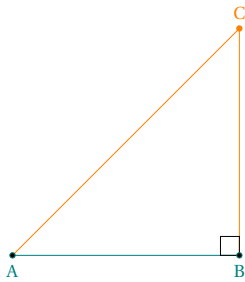
15.1.2. Use of `\tkzDefSquare` to obtain an isosceles right-angled triangle

```
\begin{tikzpicture}[scale=1]
  \tkzDefPoint(0,0){A}
  \tkzDefPoint(3,0){B}
  \tkzDefSquare(A,B) \tkzGetFirstPoint{C}
  \tkzDrawSegment(A,B)
  \tkzDrawSegments[new](A,C B,C)
  \tkzMarkRightAngles(A,B,C)
  \tkzDrawPoints(A,B) \tkzDrawPoint[new](C)
  \tkzLabelPoints(A,B)
  \tkzLabelPoints[new,above](C)
\end{tikzpicture}
```

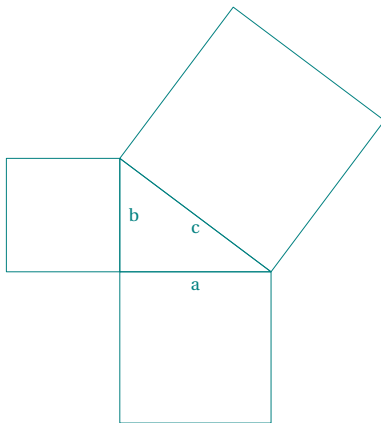
15.1.3. Pythagorean Theorem and `\tkzDefSquare`

```
\begin{tikzpicture}[scale=.5]
  \tkzDefPoint(0,0){C}
  \tkzDefPoint(4,0){A}
  \tkzDefPoint(0,3){B}
  \tkzDefSquare(B,A)\tkzGetPoints{E}{F}
  \tkzDefSquare(A,C)\tkzGetPoints{G}{H}
  \tkzDefSquare(C,B)\tkzGetPoints{I}{J}
  \tkzDrawPolygon(A,B,C)
  \tkzDrawPolygon(A,C,G,H)
  \tkzDrawPolygon(C,B,I,J)
  \tkzDrawPolygon(B,A,E,F)
  \tkzLabelSegment(A,C){$a$}
  \tkzLabelSegment[right](C,B){$b$}
  \tkzLabelSegment[swap](A,B){$c$}
\end{tikzpicture}
```

15.2. Defining the points of a rectangle

.

```
\tkzDefRectangle(<pt1,pt2>)
```

The rectangle is defined in the forward direction. From two points, two more points are obtained such that the four taken in order form a rectangle. The two points passed in arguments are the ends of a diagonal of the rectangle. The sides are parallel to the axes.

The results are in `tkzFirstPointResult` and `tkzSecondPointResult`.

We can rename them with `\tkzGetPoints`.

Arguments	example	explanation
<code>(<pt1,pt2>)</code>	<code>\tkzDefRectangle(<A,B>)</code>	The rectangle is defined in the direct direction.

15.2.1. Example of a rectangle definition

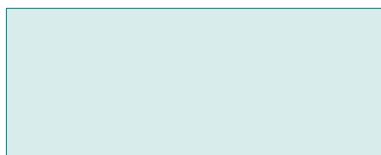

```
\begin{tikzpicture}
  \tkzDefPoints{0/0/A,5/2/C}
  \tkzDefRectangle(A,C) \tkzGetPoints{B}{D}
  \tkzDrawPolygon[fill=teal!15](A,...,D)
\end{tikzpicture}
```

15.3. Definition of parallelogram

Defining the points of a parallelogram. It is a matter of completing three points in order to obtain a parallelogram.

<code>\tkzDefParallelogram(<pt1,pt2,pt3>)</code>		
arguments	default	definition
<code>(<pt1,pt2,pt3>)</code>	no default	Three points are necessary

From three points, another point is obtained such that the four taken in order form a parallelogram. The result is in `tkzPointResult`.

We can rename it with the name `\tkzGetPoint...`

15.3.1. Example of a parallelogram definition

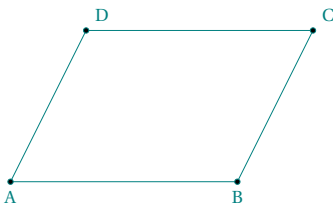

```
\begin{tikzpicture}[scale=1]
\tkzDefPoints{0/0/A,3/0/B,4/2/C}
\tkzDefParallelogram(A,B,C)
% or \tkzDefPointWith[colinear= at C](B,A)
\tkzGetPoint{D}
\tkzDrawPolygon(A,B,C,D)
\tkzLabelPoints(A,B)
\tkzLabelPoints[above right](C,D)
\tkzDrawPoints(A,...,D)
\end{tikzpicture}
```

15.4. The golden rectangle

<code>\tkzDefGoldenRectangle(<point,point>)</code>		
The macro determines a rectangle whose size ratio is the number Φ .		
The created points are in <code>tkzFirstPointResult</code> and <code>tkzSecondPointResult</code> .		
They can be obtained with the macro <code>\tkzGetPoints</code> . The following macro is used to draw the rectangle.		
arguments	example	explanation
<code>(<pt1,pt2>)</code>	<code>(<A,B>)</code>	If C and D are created then $AB/BC = \Phi$.
<code>\tkzDefGoldenRectangle</code> or <code>\tkzDefGoldRectangle</code>		

15.4.1. Golden Rectangles

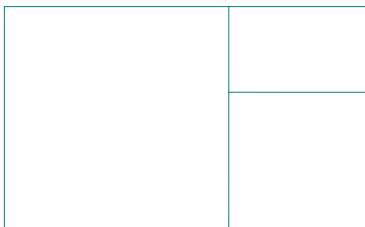

```
\begin{tikzpicture}[scale=.6]
\tkzDefPoint(0,0){A} \tkzDefPoint(8,0){B}
\tkzDefGoldRectangle(A,B) \tkzGetPoints{C}{D}
\tkzDefGoldRectangle(B,C) \tkzGetPoints{E}{F}
\tkzDefGoldRectangle(C,E) \tkzGetPoints{G}{H}
\tkzDrawPolygon(A,B,C,D)
\tkzDrawSegments(E,F G,H)
\end{tikzpicture}
```

15.4.2. Construction of the golden rectangle

Without the previous macro here is how to get the golden rectangle.

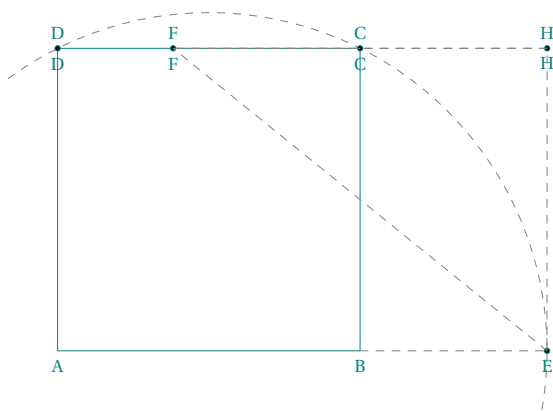

```
\begin{tikzpicture}[scale=.5]
\tkzDefPoint(0,0){A}
\tkzDefPoint(8,0){B}
\tkzDefMidPoint(A,B)
\tkzGetPoint{I}
\tkzDefSquare(A,B)\tkzGetPoints{C}{D}
\tkzInterLC(A,B)(I,C)\tkzGetPoints{G}{E}
\tkzDefPointWith[colinear= at C](E,B)
\tkzGetPoint{F}
\tkzDefPointBy[projection=onto D--C](E)
\tkzGetPoint{H}
\tkzDrawArc[style=dashed](I,E)(D)
\tkzDrawPolygon(A,B,C,D)
\tkzDrawPoints(C,D,E,F,H)
\tkzLabelPoints(A,B,C,D,E,F,H)
\tkzLabelPoints[above](C,D,F,H)
\tkzDrawSegments[style=dashed,color=gray]%(E,F C,F B,E F,H H,C E,H)
\end{tikzpicture}
```

15.5. Regular polygon

```
\tkzDefRegPolygon[<local options>](<pt1,pt2>)
```

From the number of sides, depending on the options, this macro determines a regular polygon according to its center or one side.

arguments	example	explanation
$(\langle pt1,pt2 \rangle)$	$(\langle O,A \rangle)$	with option "center", O is the center of the polygon.
$(\langle pt1,pt2 \rangle)$	$(\langle A,B \rangle)$	with option "side", [AB] is a side.

options	default	example
name	P	The vertices are named P1,P2,...
sides	5	number of sides.
center	center	The first point is the center.
side	center	The two points are vertices.
Options TikZ	...	

15.5.1. Option center

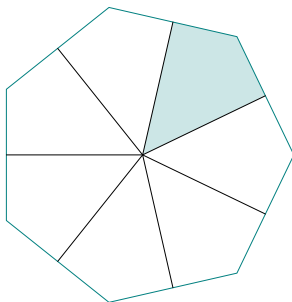

```
\begin{tikzpicture}
\tkzDefPoints{0/0/P0,0/0/Q0,2/0/P1}
\tkzDefMidPoint(P0,P1) \tkzGetPoint{Q1}
\tkzDefRegPolygon[center,sides=7](P0,P1)
\tkzDefMidPoint(P1,P2) \tkzGetPoint{Q1}
\tkzDefRegPolygon[center,sides=7,name=Q](P0,Q1)
\tkzFillPolygon[teal!20](Q0,Q1,P2,Q2)
\tkzDrawPolygon(P1,P...P7)
\foreach \j in {1,...,7} {
\tkzDrawSegment[black](P0,Q\j)}
\end{tikzpicture}
```

15.5.2. Option side

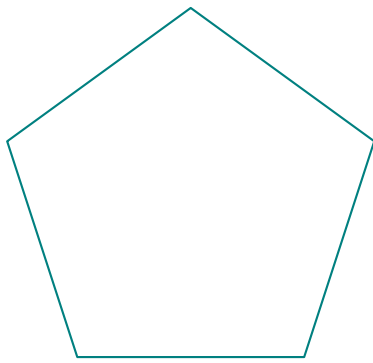

```
\begin{tikzpicture}[scale=1]
  \tkzDefPoints{-4/0/A, -1/0/B}
  \tkzDefRegPolygon[side,sides=5,name=P](A,B)
  \tkzDrawPolygon[thick](P1,P...,P5)
\end{tikzpicture}
```

16. Circles

Among the following macros, one will allow you to draw a circle, which is not a real feat. To do this, you will need to know the center of the circle and either the radius of the circle or a point on the circumference. It seemed to me that the most frequent use was to draw a circle with a given center passing through a given point. This will be the default method, otherwise you will have to use the R option. There are a large number of special circles, for example the circle circumscribed by a triangle.

- I have created a first macro `\tkzDefCircle` which allows, according to a particular circle, to retrieve its center and the measurement of the radius in cm. This recovery is done with the macros `\tkzGetPoint` and `\tkzGetLength`;
- then a macro `\tkzDrawCircle`;
- then a macro that allows you to color in a disc, but without drawing the circle `\tkzFillCircle`;
- sometimes, it is necessary for a drawing to be contained in a disk, this is the role assigned to `\tkzClipCircle`;
- it finally remains to be able to give a label to designate a circle and if several possibilities are offered, we will see here `\tkzLabelCircle`.

16.1. Characteristics of a circle: `\tkzDefCircle`

This macro allows you to retrieve the characteristics (center and radius) of certain circles.

```
\tkzDefCircle[local options](<A,B>) or (<A,B,C>)
```



Attention the arguments are lists of two or three points. This macro is either used in partnership with `\tkzGetPoints` to obtain the center and a point on the circle, or by using `tkzFirstPointResult` and `tkzSecondPointResult` if it is not necessary to keep the results. You can also use `\tkzGetLength` to get the radius.

arguments	example	explanation
<code>(<i><pt1,pt2></i>)</code> or <code>(<i><pt1,pt2,pt3></i>)</code>	<code>(<i><A,B></i>)</code>	<code>[AB]</code> is radius A is the center
options	default	definition
R	circum	circle characterized by a center and a radius
diameter	circum	circle characterized by two points defining a diameter
circum	circum	circle circumscribed of a triangle
in	circum	incircle a triangle
ex	circum	excircle of a triangle
euler or nine	circum	Euler's Circle
spieker	circum	Spieker Circle
apollonius	circum	circle of Apollonius
orthogonal from	circum	<code>[orthogonal from = A](O,M)</code>
orthogonal through	circum	<code>[orthogonal through = A and B](O,M)</code>
K	1	coefficient used for a circle of Apollonius

In the following examples, I draw the circles with a macro not yet presented. You may only need the center and a point on the circle.

16.1.1. Example with option R

We obtain with the macro `\tkzGetPoint` a point of the circle which is the East pole.

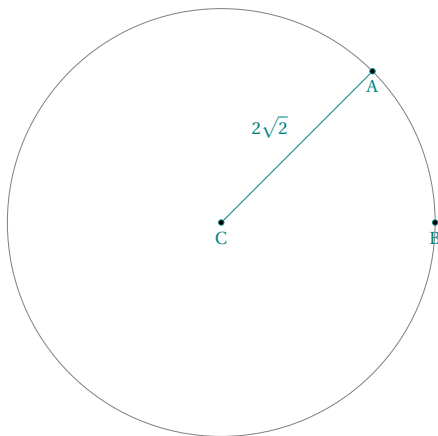

```
\begin{tikzpicture}[scale=1]
  \tkzDefPoint(3,3){C}
  \tkzDefPoint(5,5){A}
  \tkzCalcLength(A,C) \tkzGetLength{rAC}
  \tkzDefCircle[R](C,\rAC) \tkzGetPoint{B}
  \tkzDrawCircle(C,B)
  \tkzDrawSegment(C,A)
  \tkzLabelSegment[above left](C,A){ $2\sqrt{2}$ }
  \tkzDrawPoints(A,B,C)
  \tkzLabelPoints(A,C,B)
\end{tikzpicture}
```

16.1.2. Example with option diameter

It is simpler here to search directly for the middle of [AB]. The result is the center and if necessary

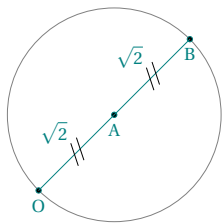

```
\begin{tikzpicture}
  \tkzDefPoint(0,0){O}
  \tkzDefPoint(2,2){B}
  \tkzDefCircle[diameter](O,B) \tkzGetPoint{A}
  \tkzDrawCircle(A,B)
  \tkzDrawPoints(O,A,B)
  \tkzDrawSegment(O,B)
  \tkzLabelPoints(O,A,B)
  \tkzLabelSegment[above left](O,A){ $\sqrt{2}$ }
  \tkzLabelSegment[above left](A,B){ $\sqrt{2}$ }
  \tkzMarkSegments[mark=s||](O,A A,B)
\end{tikzpicture}
```

16.1.3. Circles inscribed and circumscribed for a given triangle

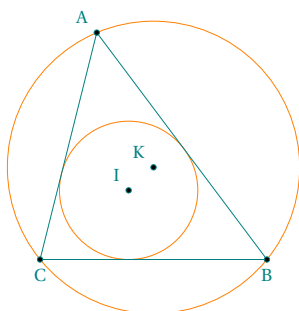

```
\begin{tikzpicture}[scale=.75]
  \tkzDefPoint(2,2){A} \tkzDefPoint(5,-2){B}
  \tkzDefPoint(1,-2){C}
  \tkzDefCircle[in](A,B,C)
  \tkzGetPoints{I}{x}
  \tkzDefCircle[circum](A,B,C)
  \tkzGetPoint{K}
  \tkzDrawCircles[new](I,x K,A)
  \tkzLabelPoints[below](B,C)
  \tkzLabelPoints[above left](A,I,K)
  \tkzDrawPolygon(A,B,C)
  \tkzDrawPoints(A,B,C,I,K)
\end{tikzpicture}
```

16.1.4. Example with option ex

We want to define an excircle of a triangle relatively to point C

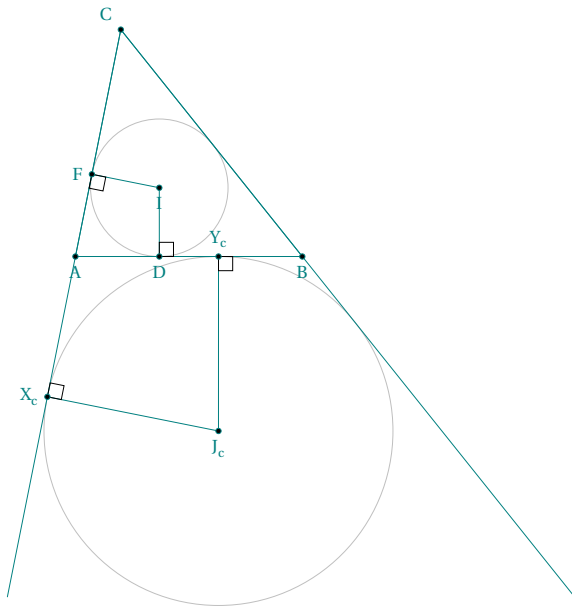

```

\begin{tikzpicture}[scale=.75]
  \tkzDefPoints{ 0/0/A,4/0/B,0.8/4/C}
  \tkzDefCircle[ex] (B,C,A)
  \tkzGetPoints{J_c}{h}
  \tkzDefPointBy[projection=onto A--C ](J_c)
  \tkzGetPoint{X_c}
  \tkzDefPointBy[projection=onto A--B ](J_c)
  \tkzGetPoint{Y_c}
  \tkzDefCircle[in] (A,B,C)
  \tkzGetPoints{I}{y}
  \tkzDrawCircles[color=lightgray] (J_c,h I,y)
  \tkzDefPointBy[projection=onto A--C ](I)
  \tkzGetPoint{F}
  \tkzDefPointBy[projection=onto A--B ](I)
  \tkzGetPoint{D}
  \tkzDrawPolygon(A,B,C)
  \tkzDrawLines[add=0 and 1.5] (C,A C,B)
  \tkzDrawSegments(J_c,X_c I,D I,F J_c,Y_c)
  \tkzMarkRightAngles(A,F,I B,D,I J_c,X_c,A J_c,Y_c,B)
  \tkzDrawPoints(B,C,A,I,D,F,X_c,J_c,Y_c)
  \tkzLabelPoints(B,A,J_c,I,D)
  \tkzLabelPoints[above] (Y_c)
  \tkzLabelPoints[left] (X_c)
  \tkzLabelPoints[above left] (C)
  \tkzLabelPoints[left] (F)
\end{tikzpicture}

```

16.1.5. Euler's circle for a given triangle with option euler

We verify that this circle passes through the middle of each side.

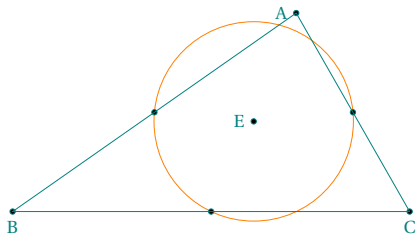

```

\begin{tikzpicture}[scale=.75]
  \tkzDefPoint(5,3.5){A}
  \tkzDefPoint(0,0){B} \tkzDefPoint(7,0){C}
  \tkzDefCircle[euler] (A,B,C)
  \tkzGetPoints{E}{e}
  \tkzDefSpcTriangle[medial] (A,B,C){M_a,M_b,M_c}
  \tkzDrawCircle[new] (E,e)
  \tkzDrawPoints(A,B,C,E,M_a,M_b,M_c)
  \tkzDrawPolygon(A,B,C)
  \tkzLabelPoints[below] (B,C)
  \tkzLabelPoints[left] (A,E)
\end{tikzpicture}

```

16.1.6. Apollonius circles for a given segment option apollonius

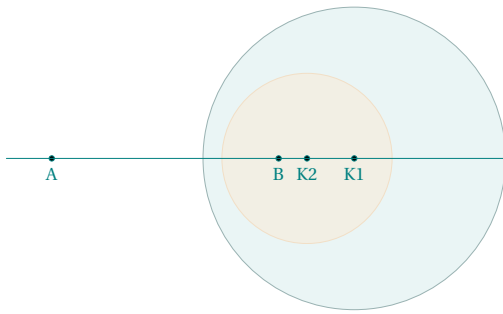

```

\begin{tikzpicture}[scale=0.75]
  \tkzDefPoint(0,0){A}
  \tkzDefPoint(4,0){B}
  \tkzDefCircle[apollonius,K=2](A,B)
  \tkzGetPoints{K1}{x}
  \tkzDrawCircle[color = teal!50!black,
    fill=teal!20,opacity=.4](K1,x)
  \tkzDefCircle[apollonius,K=3](A,B)
  \tkzGetPoints{K2}{y}
  \tkzDrawCircle[color=orange!50,
    fill=orange!20,opacity=.4](K2,y)
  \tkzLabelPoints[below](A,B,K1,K2)
  \tkzDrawPoints(A,B,K1,K2)
  \tkzDrawLine[add=.2 and 1](A,B)
\end{tikzpicture}

```

16.1.7. Circles exinscribed to a given triangle option ex

You can also get the center and the projection of it on one side of the triangle.
with `\tkzGetFirstPoint{Jb}` and `\tkzGetSecondPoint{Tb}`.

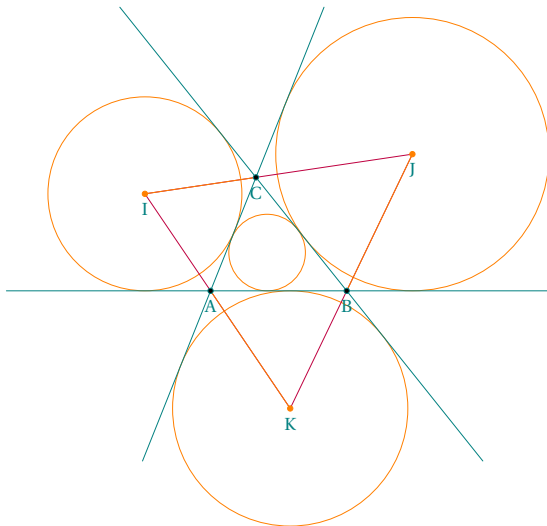

```

\begin{tikzpicture}[scale=.6]
  \tkzDefPoint(0,0){A}
  \tkzDefPoint(3,0){B}
  \tkzDefPoint(1,2.5){C}
  \tkzDefCircle[ex](A,B,C) \tkzGetPoints{I}{i}
  \tkzDefCircle[ex](C,A,B) \tkzGetPoints{J}{j}
  \tkzDefCircle[ex](B,C,A) \tkzGetPoints{K}{k}
  \tkzDefCircle[in](B,C,A) \tkzGetPoints{o}{o}
  \tkzDrawCircles[new](J,j I,i K,k O,o)
  \tkzDrawLines[add=1.5 and 1.5](A,B A,C B,C)
  \tkzDrawPolygon[purple](I,J,K)
  \tkzDrawSegments[new](A,K B,J C,I)
  \tkzDrawPoints(A,B,C)
  \tkzDrawPoints[new](I,J,K)
  \tkzLabelPoints(A,B,C,I,J,K)
\end{tikzpicture}

```

16.1.8. Spieker circle with option spieker

The incircle of the medial triangle $M_aM_bM_c$ is the Spieker circle:

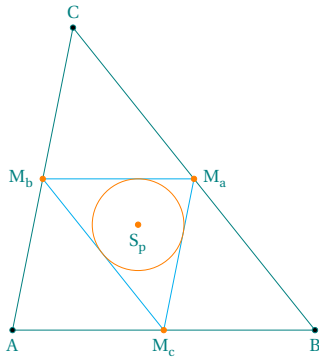

```

\begin{tikzpicture}[scale=1]
  \tkzDefPoints{ 0/0/A,4/0/B,0.8/4/C}
  \tkzDefSpcTriangle[medial](A,B,C){M_a,M_b,M_c}
  \tkzDefTriangleCenter[spieker](A,B,C)
  \tkzGetPoint{S_p}
  \tkzDrawPolygon(A,B,C)
  \tkzDrawPolygon[cyan](M_a,M_b,M_c)
  \tkzDrawPoints(B,C,A)
  \tkzDefCircle[spieker](A,B,C)
  \tkzDrawPoints[new](M_a,M_b,M_c,S_p)
  \tkzDrawCircle[new](tkzFirstPointResult,tkzSecondPointResult)
  \tkzLabelPoints[right](M_a)
  \tkzLabelPoints[left](M_b)
  \tkzLabelPoints[below](A,B,M_c,S_p)
  \tkzLabelPoints[above](C)
\end{tikzpicture}

```

16.2. Projection of excenters

```
\tkzDefProjExcenter[⟨local options⟩](⟨A,B,C⟩)(⟨a,b,c⟩){⟨X,Y,Z⟩}
```

Each excenter has three projections on the sides of the triangle ABC. We can do this with one macro

```
\tkzDefProjExcenter[name=J](A,B,C)(a,b,c){Y,Z,X}.
```

options	default	definition
name	no default	used to name the vertices
arguments	default	definition
(pt1= α_1 ,pt2= α_2 ,...)	no default	Each point has a assigned weight

16.2.1. Excircles

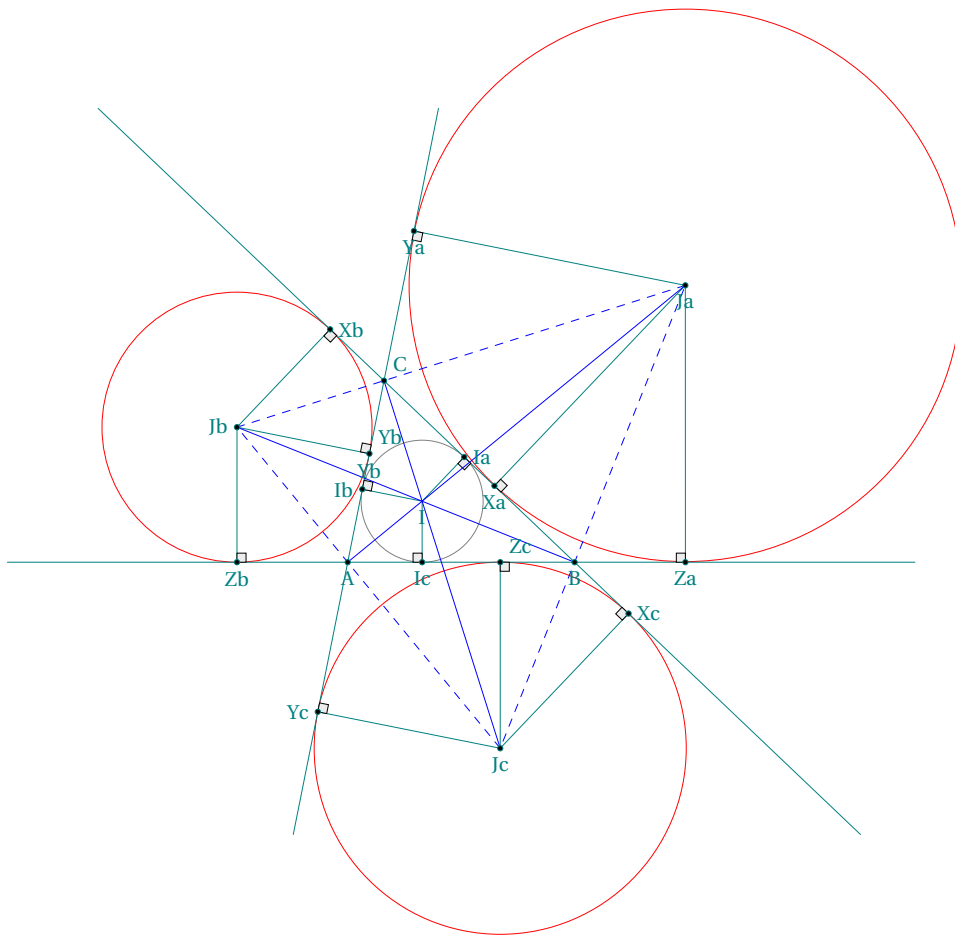

```

\begin{tikzpicture}[scale=.6]
\tikzset{line style/.append style={line width=.2pt}}
\tikzset{label style/.append style={color=teal,font=\footnotesize}}
\tkzDefPoints{0/0/A,5/0/B,0.8/4/C}
\tkzDefSpcTriangle[excentral,name=J](A,B,C){a,b,c}
\tkzDefSpcTriangle[intouch,name=I](A,B,C){a,b,c}
\tkzDefProjExcenter[name=J](A,B,C)(a,b,c){X,Y,Z}
\tkzDefCircle[in](A,B,C)\tkzGetPoint{I}\tkzGetSecondPoint{T}
\tkzDrawCircles[red](Ja,Xa Jb,Yb Jc,Zc)
\tkzDrawCircle(I,T)
\tkzDrawPolygon[dashed,color=blue](Ja,Jb,Jc)
\tkzDrawLines[add=1.5 and 1.5](A,C A,B B,C)
\tkzDrawSegments(Ja,Xa Ja,Ya Ja,Za
                Jb,Xb Jb,Yb Jb,Zb
                Jc,Xc Jc,Yc Jc,Zc
                I,Ia I,Ib I,Ic)
\tkzMarkRightAngles[size=.2,fill=gray!15](Ja,Za,B Ja,Xa,B Ja,Ya,C Jb,Yb,C)
\tkzMarkRightAngles[size=.2,fill=gray!15](Jb,Zb,B Jb,Xb,C Jc,Yc,A Jc,Zc,B Jc,Xc,C I,Ia,B I,Ib,C I,Ic,A)
\tkzDrawSegments[blue](Jc,C Ja,A Jb,B)
\tkzDrawPoints(A,B,C,Xa,Xb,Xc,Ja,Jb,Jc,Ia,Ib,Ic,Ya,Yb,Yc,Za,Zb,Zc)
\tkzLabelPoints(A,Ya,Yb,Ja,I)
\tkzLabelPoints[left](Jb,Ib,Yc)
\tkzLabelPoints[below](Zb,Ic,Jc,B,Za,Xa)
\tkzLabelPoints[above right](C,Zc,Yb)
\tkzLabelPoints[right](Xb,Ia,Xc)
\end{tikzpicture}

```

16.2.2. Orthogonal from

Orthogonal circle of given center. `\tkzGetPoints{z1}{z2}` gives two points of the circle.

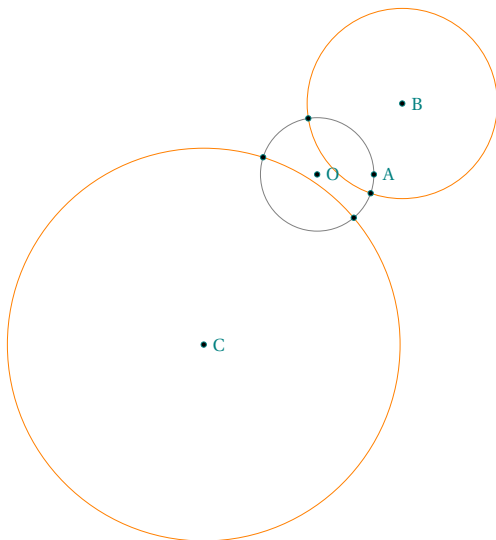

```

\begin{tikzpicture}[scale=.75]
\tkzDefPoints{0/0/0,1/0/A}
\tkzDefPoints{1.5/1.25/B,-2/-3/C}
\tkzDefCircle[orthogonal from=B](O,A)
\tkzGetPoints{z1}{z2}
\tkzDefCircle[orthogonal from=C](O,A)
\tkzGetPoints{t1}{t2}
\tkzDrawCircle(O,A)
\tkzDrawCircles[new](B,z1 C,t1)
\tkzDrawPoints(t1,t2,C)
\tkzDrawPoints(z1,z2,O,A,B)
\tkzLabelPoints[right](O,A,B,C)
\end{tikzpicture}

```

16.2.3. Orthogonal through

Orthogonal circle passing through two given points.

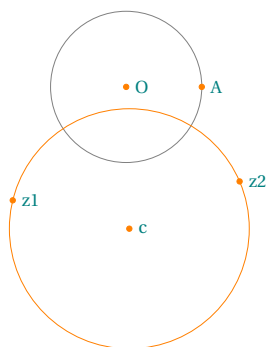

```

\begin{tikzpicture}[scale=1]
  \tkzDefPoint(0,0){O}
  \tkzDefPoint(1,0){A}
  \tkzDrawCircle(O,A)
  \tkzDefPoint(-1.5,-1.5){z1}
  \tkzDefPoint(1.5,-1.25){z2}
  \tkzDefCircle[orthogonal through=z1 and z2](O,A)
  \tkzGetPoint{c}
  \tkzDrawCircle[new](tkzPointResult,z1)
  \tkzDrawPoints[new](O,A,z1,z2,c)
  \tkzLabelPoints[right](O,A,z1,z2,c)
\end{tikzpicture}

```

16.3. Definition of circle by transformation; `\tkzDefCircleBy`

These transformations are:

- translation;
- homothety;
- orthogonal reflection or symmetry;
- central symmetry;
- orthogonal projection;
- rotation (degrees);
- inversion.

The choice of transformations is made through the options. The macro is `\tkzDefCircleBy` and the other for the transformation of a list of points `\tkzDefCirclesBy`. For example, we'll write:

```
\tkzDefCircleBy[translation= from A to A'](O,M)
```

O is the center and M is a point on the circle. The image is a circle. The new center is `tkzFirstPointResult` and `tkzSecondPointResult` is a point on the new circle. You can get the results with the macro `\tkzGetPoints`.

```
\tkzDefCircleBy[<local options>](<pt1,pt2>)
```

The argument is a couple of points. The results is a couple of points. If you want to keep these points then the macro `\tkzGetPoints{O'}{M'}` allows you to assign the name O' to the center and M' to the point on the circle.

arguments	definition	examples
pt1,pt2	existing points	(O,M)
options	examples	
translation	= from #1 to #2	[translation=from A to B](O,M)
homothety	= center #1 ratio #2	[homothety=center A ratio .5](O,M)
reflection	= over #1--#2	[reflection=over A--B](O,M)
symmetry	= center #1	[symmetry=center A](O,M)
projection	= onto #1--#2	[projection=onto A--B](O,M)
rotation	= center #1 angle #2	[rotation=center O angle 30](O,M)
inversion	= center #1 through #2	[inversion =center O through A](O,M)

The image is only defined and not drawn.

16.3.1. Translation

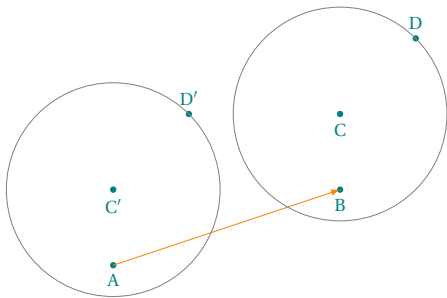

```
\begin{tikzpicture}[>=latex]
\tkzDefPoint(0,0){A} \tkzDefPoint(3,1){B}
\tkzDefPoint(3,2){C} \tkzDefPoint(4,3){D}
\tkzDefCircleBy[translation= from B to A](C,D)
\tkzGetPoints{C'}{D'}
\tkzDrawPoints[teal](A,B,C,D,C',D')
\tkzDrawSegments[orange,->](A,B)
\tkzDrawCircles(C,D C',D')
\tkzLabelPoints[color=teal](A,B,C,C')
\tkzLabelPoints[color=teal,above](D,D')
\end{tikzpicture}
```

16.3.2. Reflection (orthogonal symmetry)

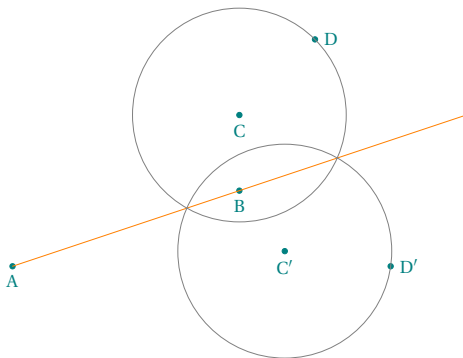

```
\begin{tikzpicture}[>=latex]
\tkzDefPoint(0,0){A} \tkzDefPoint(3,1){B}
\tkzDefPoint(3,2){C} \tkzDefPoint(4,3){D}
\tkzDefCircleBy[reflection = over A--B](C,D)
\tkzGetPoints{C'}{D'}
\tkzDrawPoints[teal](A,B,C,D,C',D')
\tkzDrawLine[add =0 and 1][orange](A,B)
\tkzDrawCircles(C,D C',D')
\tkzLabelPoints[color=teal](A,B,C,C')
\tkzLabelPoints[color=teal,right](D,D')
\end{tikzpicture}
```

16.3.3. Homothety

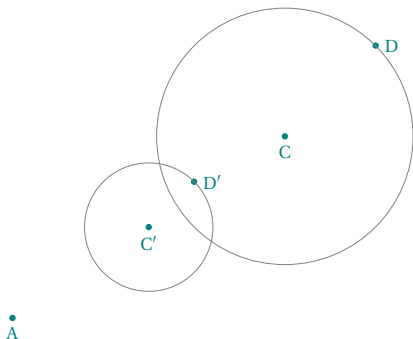

```
\begin{tikzpicture}[scale=1.2]
\tkzDefPoint(0,0){A} \tkzDefPoint(3,1){B}
\tkzDefPoint(3,2){C} \tkzDefPoint(4,3){D}
\tkzDefCircleBy[homothety=center A ratio .5](C,D)
\tkzGetPoints{C'}{D'}
\tkzDrawPoints[teal](A,C,D,C',D')
\tkzDrawCircles(C,D C',D')
\tkzLabelPoints[color=teal](A,C,C')
\tkzLabelPoints[color=teal,right](D,D')
\end{tikzpicture}
```

16.3.4. Symmetry

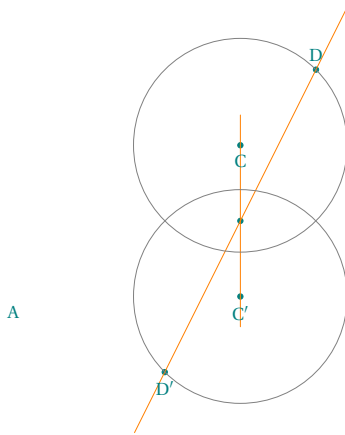

```

\begin{tikzpicture}[scale=1]
  \tkzDefPoint(0,0){A}   \tkzDefPoint(3,1){B}
  \tkzDefPoint(3,2){C}   \tkzDefPoint(4,3){D}
  \tkzDefCircleBy[symmetry=center B](C,D)
  \tkzGetPoints{C'}{D'}
  \tkzDrawPoints[teal](B,C,D,C',D')
  \tkzDrawLines[orange](C,C' D,D')
  \tkzDrawCircles(C,D C',D')
  \tkzLabelPoints[color=teal](A,C,C')
  \tkzLabelPoints[color=teal,above](D)
  \tkzLabelPoints[color=teal,below](D')
\end{tikzpicture}

```

16.3.5. Rotation

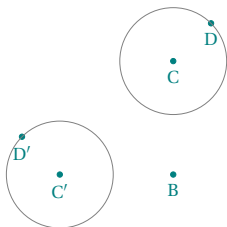

```

\begin{tikzpicture}[scale=0.5]
  \tkzDefPoint(3,-1){B}
  \tkzDefPoint(3,2){C}   \tkzDefPoint(4,3){D}
  \tkzDefCircleBy[rotation=center B angle 90](C,D)
  \tkzGetPoints{C'}{D'}
  \tkzDrawPoints[teal](B,C,D,C',D')
  \tkzLabelPoints[color=teal](B,C,D,C',D')
  \tkzDrawCircles(C,D C',D')
\end{tikzpicture}

```

16.3.6. Inversion

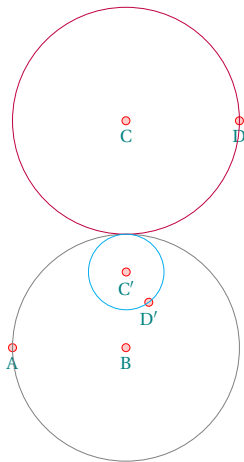

```

\begin{tikzpicture}[scale=1.5]
  \tkzSetUpPoint[size=3,color=red,fill=red!20]
  \tkzSetUpStyle[color=purple,ultra thin]{st1}
  \tkzSetUpStyle[color=cyan,ultra thin]{st2}
  \tkzDefPoint(2,0){A} \tkzDefPoint(3,0){B}
  \tkzDefPoint(3,2){C} \tkzDefPoint(4,2){D}
  \tkzDefCircleBy[inversion = center B through A](C,D)
  \tkzGetPoints{C'}{D'}
  \tkzDrawPoints(A,B,C,D,C',D')
  \tkzLabelPoints(A,B,C,D,C',D')
  \tkzDrawCircles(B,A)
  \tkzDrawCircles[st1](C,D)
  \tkzDrawCircles[st2](C',D')
\end{tikzpicture}

```

17. Intersections

It is possible to determine the coordinates of the points of intersection between two straight lines, a straight line and a circle, and two circles.

The associated commands have no optional arguments and the user must determine the existence of the intersection points himself.

17.1. Intersection of two straight lines `\tkzInterLL`

$$\text{\tkzInterLL}(\langle A,B \rangle) (\langle C,D \rangle)$$

Defines the intersection point `\tkzPointResult` of the two lines (AB) and (CD). The known points are given in pairs (two per line) in brackets, and the resulting point can be retrieved with the macro `\tkzDefPoint`.

17.1.1. Example of intersection between two straight lines

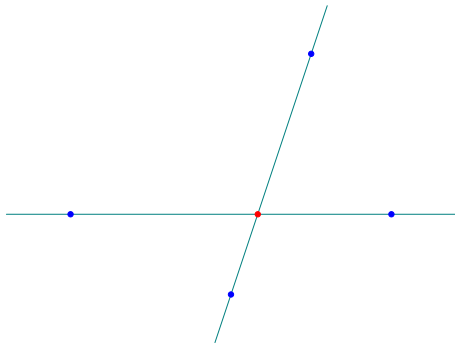

```
\begin{tikzpicture}[rotate=-45,scale=.75]
  \tkzDefPoint(2,1){A}
  \tkzDefPoint(6,5){B}
  \tkzDefPoint(3,6){C}
  \tkzDefPoint(5,2){D}
  \tkzDrawLines(A,B C,D)
  \tkzInterLL(A,B) (C,D)
  \tkzGetPoint{I}
  \tkzDrawPoints[color=blue] (A,B,C,D)
  \tkzDrawPoint[color=red] (I)
\end{tikzpicture}
```

17.2. Intersection of a straight line and a circle `\tkzInterLC`

As before, the line is defined by a couple of points. The circle is also defined by a couple:

- (O,C) which is a pair of points, the first is the center and the second is any point on the circle.
- (O,r) The r measure is the radius measure.

$$\text{\tkzInterLC}[\langle \text{options} \rangle] (\langle A,B \rangle) (\langle O,C \rangle) \text{ or } (\langle O,r \rangle) \text{ or } (\langle O,C,D \rangle)$$

So the arguments are two couples.

options	default	definition
N	N	(O,C) determines the circle
R	N	(O, 1) unit 1 cm
with nodes	N	(O,C,D) CD is a radius
common=pt		pt is common point; <code>\tkzFirstPoint</code> gives the other point
near		<code>\tkzFirstPoint</code> is the closest point to the first point of the line

The macro defines the intersection points I and J of the line (AB) and the center circle O with radius r if they exist; otherwise, an error will be reported in the .log file. **with nodes** avoids you to calculate the radius which is the length of [CD]. If **common** and **near** are not used then `\tkzFirstPoint` is the smallest angle (angle with `\tkzSecondPoint` and the center of the circle).

$$\text{\tkzTestInterLC}(\langle O,A \rangle) (\langle O',B \rangle)$$

So the arguments are two couples which define a line and a circle with a center and a point on the circle. If there is a non empty intersection between these the line and the circle then the test `\if\tkzFlagLC` gives true.

17.2.1. test line-circle intersection

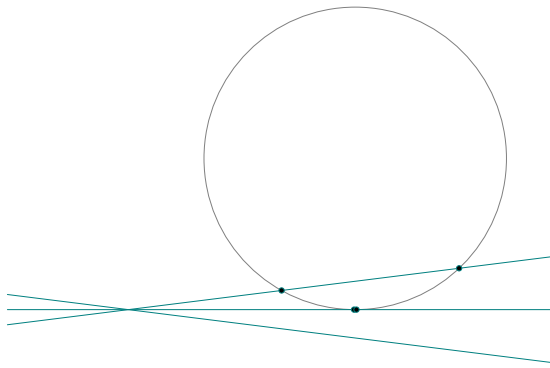

```

\begin{tikzpicture}[scale=1]
  \tkzDefPoints{% x   y   name
                 3   /4   /I,
                 3   /2   /P,
                 0   /2   /La,
                 8   /3   /Lb}

  \tkzDrawCircle(I,P)
  \foreach \i in {1,...,3}{%
    \coordinate (Lb) at (8,\i);
    \tkzDrawLine(La,Lb)
    \tkzTestInterLC(La,Lb)(I,P)
    \iftkzFlagLC
      \tkzInterLC(La,Lb)(I,P)
      \tkzGetPoints{a}{b}
      \tkzDrawPoints(a,b)
    \fi
  }
\end{tikzpicture}

```

17.2.2. Line-circle intersection

In the following example, the drawing of the circle uses two points and the intersection of the straight line and the circle uses two pairs of points. We will compare the angles $\widehat{D,E,O}$ and $\widehat{E,D,O}$. These angles are in opposite directions. `tkzFirstPoint` is assigned to the point that forms the angle with the smallest measure (counterclockwise direction). The counterclockwise angle $\widehat{D,E,O}$ has a measure equal to 360° minus the measure of $\widehat{O,E,D}$.

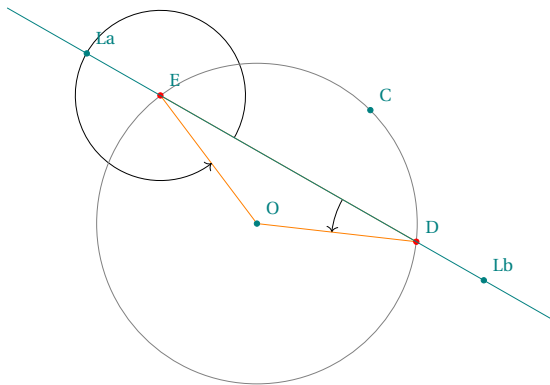

```

\begin{tikzpicture}[scale=.75]
  \tkzInit[xmax=5,ymax=4]
  \tkzDefPoint(1,1){O}
  \tkzDefPoint(-2,4){La}
  \tkzDefPoint(5,0){Lb}
  \tkzDefPoint(3,3){C}
  \tkzInterLC(La,Lb)(O,C) \tkzGetPoints{D}{E}
  \tkzMarkAngle[->,size=1.5](E,D,O)
  \tkzDrawPolygons[new](O,D,E)
  \tkzMarkAngle[->,size=1.5](D,E,O)
  \tkzDrawCircle(O,C)
  \tkzDrawPoints[color=teal](O,La,Lb,C)
  \tkzDrawPoints[color=red](D,E)
  \tkzDrawLine(La,Lb)
  \tkzLabelPoints[above right](O,La,Lb,C,D,E)
\end{tikzpicture}

```

17.2.3. Line passing through the center option common

This case is special. You cannot compare the angles. In this case, the option `near` must be used. `tkzFirstPoint` is assigned to the point closest to the first point given for the line. Here we want A to be closest to Lb.

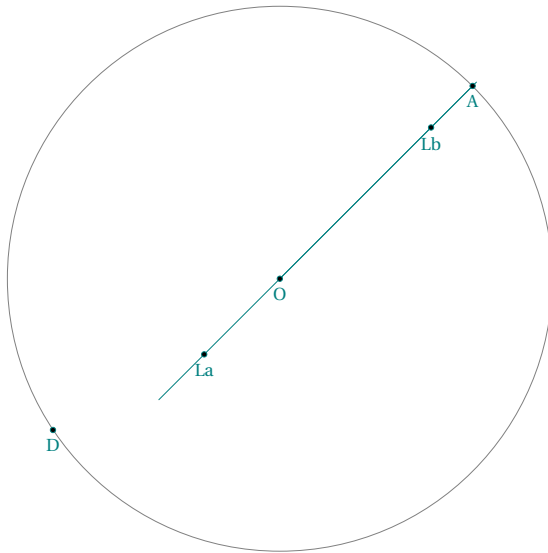

```

\begin{tikzpicture}
\tkzDefPoints{% x    y    name
                0    /1   /D,
                6    /0   /B,
                3    /3   /O,
                2    /2   /La,
                5    /5   /Lb}
\tkzDrawCircle(0,D)
\tkzDrawLine(La,Lb)
\tkzInterLC[near](Lb,La)(0,D)
\tkzGetFirstPoint{A}
\tkzDrawSegments(O,A)
\tkzDrawPoints(O,D,A,La,Lb)
\tkzLabelPoints(O,D,A,La,Lb)
\end{tikzpicture}

```

17.2.4. Line-circle intersection with option common

A special case that we often meet, a point of the line is on the circle and we are looking for the other common point.

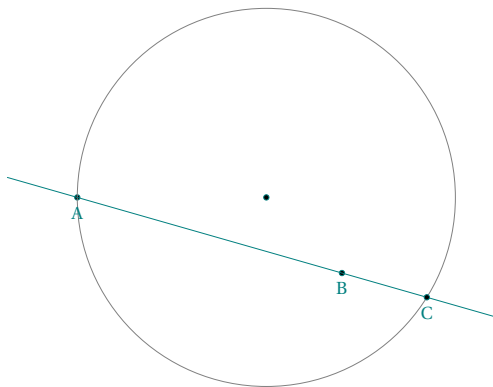

```

\begin{tikzpicture}[scale=.5]
\tkzDefPoints{0/0/O,-5/0/A,2/-2/B,0/5/D}
\tkzInterLC[common=A](B,A)(O,D)
\tkzGetFirstPoint{C}
\tkzDrawPoints(O,A,B)
\tkzDrawCircle(O,A)
\tkzDrawLine(A,C)
\tkzDrawPoint(C)
\tkzLabelPoints(A,B,C)
\end{tikzpicture}

```

17.2.5. Line-circle intersection order of points

The idea is to compare the angles formed with the first defining point of the line, a resultant point and the center of the circle. The first point is the one that corresponds to the smallest angle.

As you can see $\widehat{BCO} < \widehat{BEO}$. To tell the truth, \widehat{BEO} is counterclockwise.

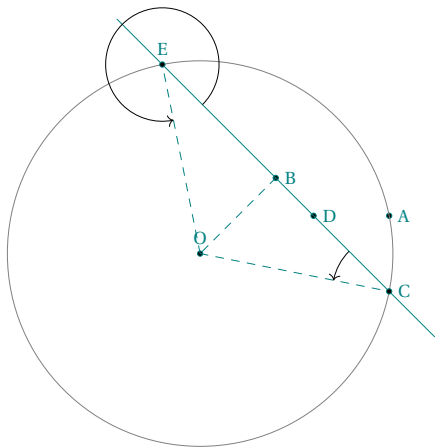

```
\begin{tikzpicture}[scale=.5]
  \tkzDefPoints{O/Q/0,5/1/A,2/2/B,3/1/D}
  \tkzInterLC[common=A] (B,D) (O,A) \tkzGetPoints{C}{E}
  \tkzDrawPoints(O,A,B,D)
  \tkzDrawCircle(O,A) \tkzDrawLine(E,C)
  \tkzDrawSegments[dashed] (B,O O,C)
  \tkzMarkAngle[->,size=1.5] (B,C,O)
  \tkzDrawSegments[dashed] (O,E)
  \tkzMarkAngle[->,size=1.5] (B,E,O)
  \tkzDrawPoints(C,E)
  \tkzLabelPoints[above] (O,E)
  \tkzLabelPoints[right] (A,B,C,D)
\end{tikzpicture}
```

17.2.6. Example with \foreach

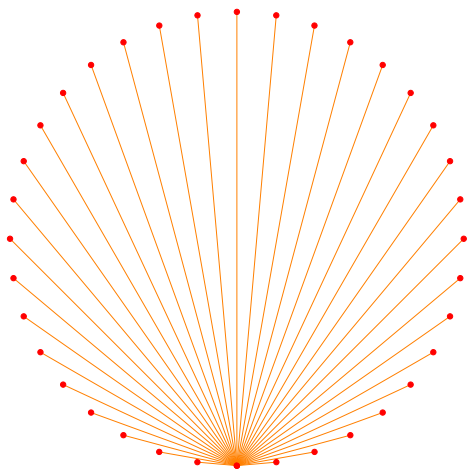

```
\begin{tikzpicture}[scale=3,rotate=180]
  \tkzDefPoint(O,1){J}
  \tkzDefPoint(O,0){O}
  \foreach \i in {0,-5,-10,...,-90}{
    \tkzDefPoint({2.5*cos(\i*pi/180)},{1+2.5*sin(\i*pi/180)}){P}
    \tkzInterLC[R] (P,J) (O,1)\tkzGetPoints{N}{M}
    \tkzDrawSegment[color=orange] (J,N)
    \tkzDrawPoints[red] (N)}
  \foreach \i in {-90,-95,...,-175,-180}{
    \tkzDefPoint({2.5*cos(\i*pi/180)},{1+2.5*sin(\i*pi/180)}){P}
    \tkzInterLC[R] (P,J) (O,1)\tkzGetPoints{N}{M}
    \tkzDrawSegment[color=orange] (J,M)
    \tkzDrawPoints[red] (M)}
\end{tikzpicture}
```

17.2.7. Line-circle intersection with option near

D is the point closest to b.

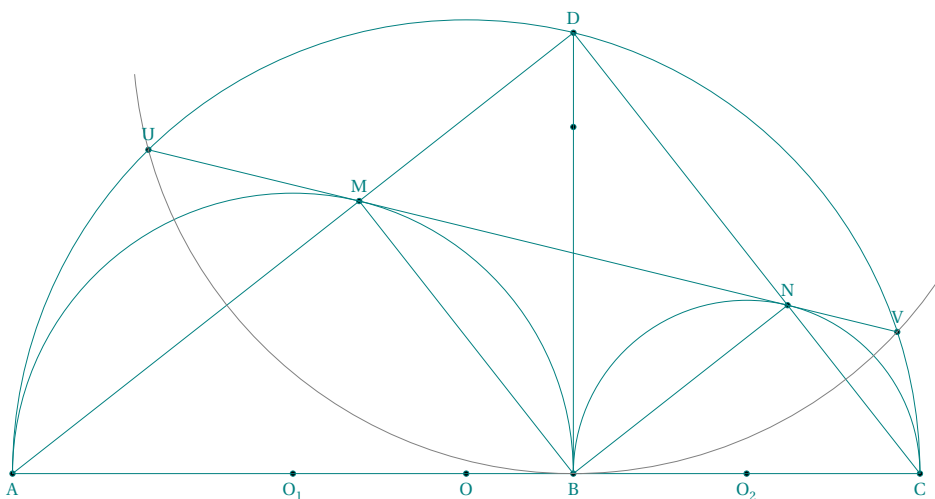

```

\begin{tikzpicture}
\tkzDefPoints{0/0/A,12/0/C}
\tkzDefGoldenRatio(A,C)
\tkzDefMidPoint(A,B)
\tkzDefMidPoint(B,C)
\tkzDefPointBy[rotation=center O_2 angle 90](C)
\tkzDefPointBy[rotation=center O_1 angle 90](B)
\tkzDefPointBy[rotation=center B angle 90](C)
\tkzInterLC[near](b,B)(O,A)
\tkzInterCC(D,B)(O,C)
\tkzDefPointBy[projection=onto U--V](O_1)
\tkzDefPointBy[projection=onto U--V](O_2)
\tkzDrawPoints(A,B,C,O,O_1,O_2,D,U,V,M,N,b)
\tkzDrawSemiCircles[teal](O,C O_1,B O_2,C)
\tkzDrawSegments(A,C B,D U,V A,D C,D M,B B,N)
\tkzDrawArc(D,U)(V)
\tkzLabelPoints(A,B,C,O,O_1,O_2)
\tkzLabelPoints[above](D,U,V,M,N)
\end{tikzpicture}

```

17.2.8. More complex example of a line-circle intersection

Figure from http://gogeometry.com/problem/p190_tangent_circle

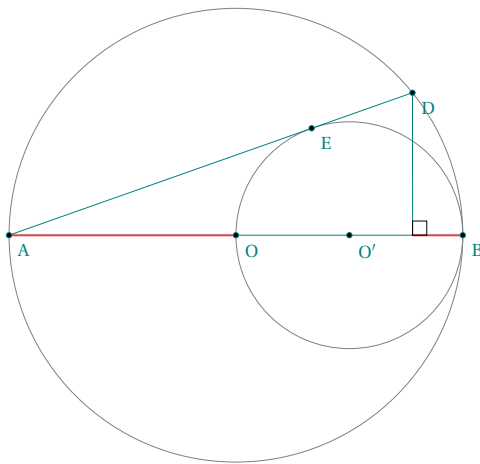

```

\begin{tikzpicture}[scale=.75]
\tkzDefPoint(0,0){A}
\tkzDefPoint(8,0){B}
\tkzDefMidPoint(A,B)
\tkzDefMidPoint(O,B)
\tkzDefLine[tangent from=A](O',B)
\tkzInterLC(A,E)(O,B)
\tkzDefPointBy[projection=onto A--B](D)
\tkzGetPoint{F}
\tkzDrawCircles(O,B O',B)
\tkzDrawSegments(A,D A,B D,F)
\tkzDrawSegments[color=red,line width=1pt,
opacity=.4](A,O F,B)
\tkzDrawPoints(A,B,O,O',E,D)
\tkzMarkRightAngle(D,F,B)
\tkzLabelPoints[below right](A,B,O,O',E,D)
\end{tikzpicture}

```

17.2.9. Circle defined by a center and a measure, and special cases

Let's look at some special cases like straight lines tangent to the circle.

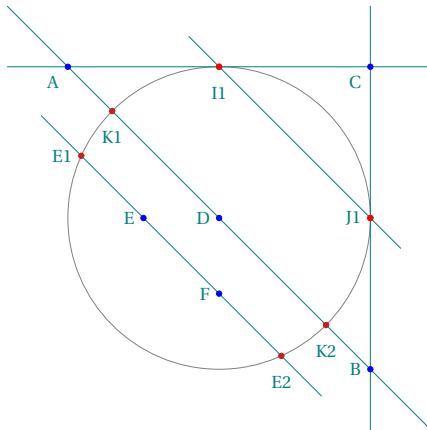

```

\begin{tikzpicture}[scale=.5]
  \tkzDefPoint(0,8){A}      \tkzDefPoint(8,0){B}
  \tkzDefPoint(8,8){C}    \tkzDefPoint(4,4){D}
  \tkzDefPoint(2,4){E}    \tkzDefPoint(4,2){F}
  \tkzDefPoint(8,4){G}
  \tkzInterLC(A,C)(D,G)   \tkzGetPoints{I1}{I2}
  \tkzInterLC(B,C)(D,G)   \tkzGetPoints{J1}{J2}
  \tkzInterLC[near](A,B)(D,G) \tkzGetPoints{K1}{K2}
  \tkzInterLC(E,F)(D,G)   \tkzGetPoints{E1}{E2}
  \tkzDrawCircle(D,G)
  \tkzDrawPoints[color=red](I1,J1,K1,K2,E1,E2)
  \tkzDrawLines(A,B B,C A,C I2,J2 E1,E2)
  \tkzDrawPoints[color=blue](A,...,F)
  \tkzDrawPoints[color=red](I2,J2)
  \tkzLabelPoints[left](B,D,E,F)
  \tkzLabelPoints[below left](A,C)
  \tkzLabelPoints[below=4pt](I1,K1,K2,E2)
  \tkzLabelPoints[left](J1,E1)
\end{tikzpicture}

```

17.2.10. Calculation of radius

With `pgfmath` and `\pgfmathsetmacro`

The radius measurement may be the result of a calculation that is not done within the intersection macro, but before. A length can be calculated in several ways. It is possible of course, to use the module `pgfmath` and the macro `\pgfmathsetmacro`. In some cases, the results obtained are not precise enough, so the following calculation $0.0002 \div 0.0001$ gives 1.98 with `pgfmath` while `xfp` will give 2.

With `xfp` and `\fpeval`:

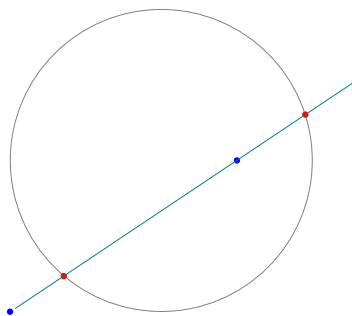

```

\begin{tikzpicture}
  \tkzDefPoint(2,2){A}
  \tkzDefPoint(5,4){B}
  \tkzDefPoint(4,4){O}
  \pgfmathsetmacro\tkzLen{\fpeval{0.0002/0.0001}}
  % or \edef\tkzLen{\fpeval{0.0002/0.0001}}
  \tkzInterLC[R](A,B)(O,\tkzLen)
  \tkzGetPoints{I}{J}
  \tkzDrawCircle(O,I)
  \tkzDrawPoints[color=blue](A,B)
  \tkzDrawPoints[color=red](I,J)
  \tkzDrawLine(I,J)
\end{tikzpicture}

```

17.2.11. Option "with nodes"

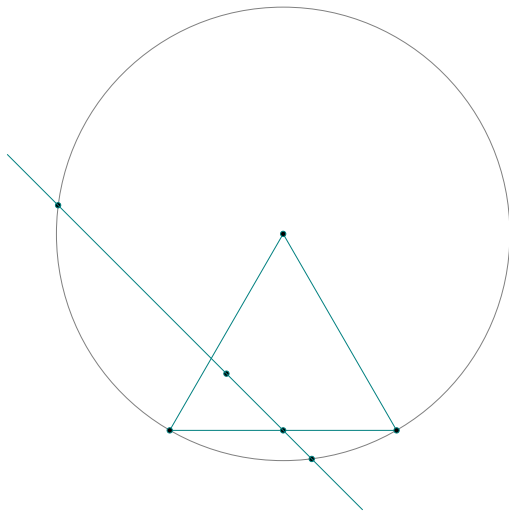

```

\begin{tikzpicture}[scale=.75]
\tkzDefPoints{0/0/A,4/0/B,1/1/D,2/0/E}
\tkzDefTriangle[equilateral](A,B)
\tkzGetPoint{C}
\tkzInterLC[with nodes](D,E)(C,A,B)
\tkzGetPoints{F}{G}
\tkzDrawCircle(C,A)
\tkzDrawPolygon(A,B,C)
\tkzDrawPoints(A,...,G)
\tkzDrawLine(F,G)
\end{tikzpicture}

```

17.3. Intersection of two circles `\tkzInterCC`

The most frequent case is that of two circles defined by their center and a point, but as before the option `R` allows to use the radius measurements.

```
\tkzInterCC[options](O,A)(O',A') or (O,r)(O',r') or (O,A,B)(O',C,D)
```

options	default	definition
<code>N</code>	<code>N</code>	<code>OA</code> and <code>O'A'</code> are radii, <code>O</code> and <code>O'</code> are the centers.
<code>R</code>	<code>N</code>	<code>r</code> and <code>r'</code> are dimensions and measure the radii.
<code>with nodes</code>	<code>N</code>	in <code>(A,A,C)(C,B,F)</code> <code>AC</code> and <code>BF</code> give the radii.
<code>common=pt</code>		<code>pt</code> is common point; <code>tkzFirstPoint</code> gives the other point.

This macro defines the intersection point(s) `I` and `J` of the two center circles `O` and `O'`. If the two circles do not have a common point then the macro ends with an error that is not handled. If the centers are `O` and `O'` and the intersections are `A` and `B` then the angles $\widehat{O,A,O'}$ and $\widehat{O,B,O'}$ are in opposite directions. `tkzFirstPoint` is assigned to the point that forms the "clockwise" angle.

```
\tkzTestInterCC(O,A)(O',B)
```

So the arguments are two couples which define two circles with a center and a point on the circle. If there is a non empty intersection between these two circles then the test `\iftkzFlagCC` gives true.

17.3.1. test circle-circle intersection

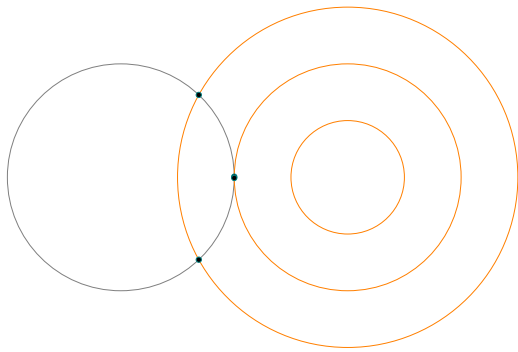

```
\begin{tikzpicture}[scale=.75]
  \tkzDefPoints{% x y name
    0 /0 /A,
    2 /0 /B,
    4 /0 /I,
    1 /0 /P}
  \tkzDrawCircle(A,B)
  \foreach \i in {1,...,3}{%
    \coordinate (P) at (\i,0);
  \tkzDrawCircle[new](I,P)
  \tkzTestInterCC(A,B)(I,P)
  \iftkzFlagCC
  \tkzInterCC(A,B)(I,P) \tkzGetPoints{a}{b}
  \tkzDrawPoints(a,b)
  \fi}
\end{tikzpicture}
```

17.3.2. circle-circle intersection with common point.

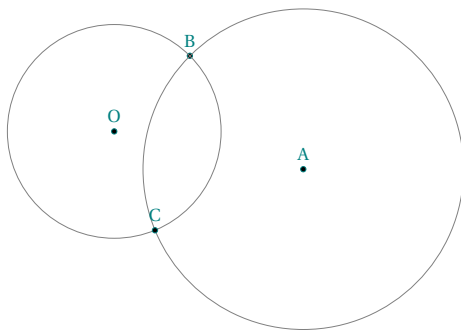

```
\begin{tikzpicture}[scale=.5]
  \tkzDefPoints{0/0/0,5/-1/A,2/2/B}
  \tkzDrawPoints(O,A,B)
  \tkzDrawCircles(O,B A,B)
  \tkzInterCC[common=B](O,B)(A,B)\tkzGetFirstPoint{C}
  \tkzDrawPoint(C)
  \tkzLabelPoints[above](O,A,B,C)
\end{tikzpicture}
```

17.3.3. circle-circle intersection order of points.

The idea is to compare the angles formed with the first center, a resultant point and the center of the second circle. The first point is the one that corresponds to the smallest angle.

As you can see $\widehat{ODB} < \widehat{OBE}$

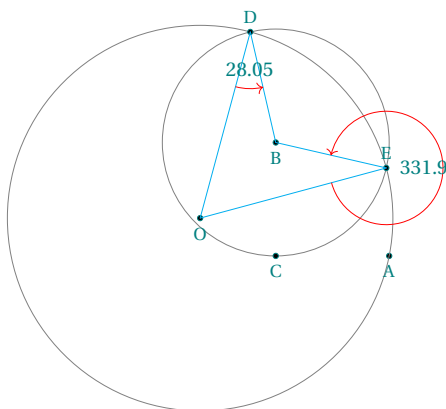

```
\begin{tikzpicture}[scale=.5]
  \pgfkeys{/pgf/number format/.cd, fixed relative, precision=4}
  \tkzDefPoints{0/0/0,5/-1/A,2/2/B,2/-1/C}
  \tkzDrawPoints(O,A,B)
  \tkzDrawCircles(O,A B,C)
  \tkzInterCC(O,A)(B,C)\tkzGetPoints{D}{E}
  \tkzDrawPoints(C,D,E)
  \tkzLabelPoints(O,A,B,C)
  \tkzLabelPoints[above](D,E)
  \tkzDrawSegments[cyan](D,O D,B)
  \tkzMarkAngle[red,->,size=1.5](O,D,B)
  \tkzFindAngle(O,D,B) \tkzGetAngle{an}
  \tkzLabelAngle(O,D,B){$\pgfmathprintnumber{\an}$}
  \tkzDrawSegments[cyan](E,O E,B)
  \tkzMarkAngle[red,->,size=1.5](O,E,B)
  \tkzFindAngle(O,E,B) \tkzGetAngle{an}
  \tkzLabelAngle(O,E,B){$\pgfmathprintnumber{\an}$}
\end{tikzpicture}
```

17.3.4. Construction of an equilateral triangle.

$\widehat{A,C,B}$ is a clockwise angle

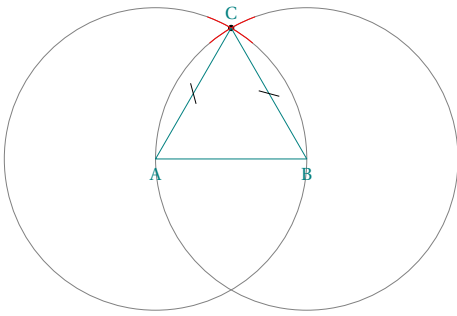

```
\begin{tikzpicture}[trim left=-1cm,scale=.5]
\tkzDefPoint(1,1){A}
\tkzDefPoint(5,1){B}
\tkzInterCC(A,B)(B,A)\tkzGetPoints{C}{D}
\tkzDrawPoint[color=black](C)
\tkzDrawCircles(A,B B,A)
\tkzCompass[color=red](A,C)
\tkzCompass[color=red](B,C)
\tkzDrawPolygon(A,B,C)
\tkzMarkSegments[mark=s|](A,C B,C)
\tkzLabelPoints[](A,B)
\tkzLabelPoint[above](C){C}
\end{tikzpicture}
```

17.3.5. Segment trisection

The idea here is to divide a segment with a ruler and a compass into three segments of equal length.

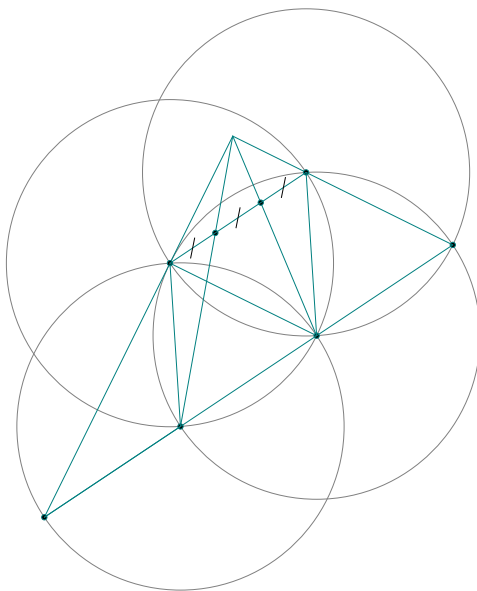

```
\begin{tikzpicture}[scale=.6]
\tkzDefPoint(0,0){A}
\tkzDefPoint(3,2){B}
\tkzInterCC(A,B)(B,A) \tkzGetSecondPoint{D}
\tkzInterCC(D,B)(B,A) \tkzGetPoints{A}{C}
\tkzInterCC(D,B)(A,B) \tkzGetPoints{E}{B}
\tkzInterLC[common=D](C,D)(E,D) \tkzGetFirstPoint{F}
\tkzInterLL(A,F)(B,C) \tkzGetPoint{O}
\tkzInterLL(O,D)(A,B) \tkzGetPoint{H}
\tkzInterLL(O,E)(A,B) \tkzGetPoint{G}
\tkzDrawCircles(D,E A,B B,A E,A)
\tkzDrawSegments[] (O,F O,B O,D O,E)
\tkzDrawPoints(A,...,H)
\tkzDrawSegments(A,B B,D A,D A,E E,F C,F B,C)
\tkzMarkSegments[mark=s|](A,G G,H H,B)
\end{tikzpicture}
```

17.3.6. With the option "with nodes"

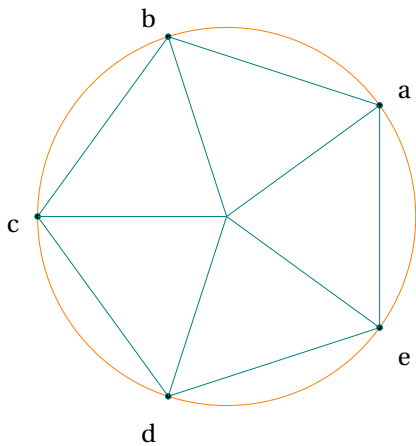

```

\begin{tikzpicture}[scale=.5]
\tkzDefPoints{0/0/A,0/5/B,5/0/C}
\tkzDefPoint(54:5){F}
\tkzInterCC[with nodes](A,A,C)(C,B,F)
\tkzGetPoints{a}{e}
\tkzInterCC(A,C)(a,e)\tkzGetFirstPoint{b}
\tkzInterCC(A,C)(b,a)\tkzGetFirstPoint{c}
\tkzInterCC(A,C)(c,b)\tkzGetFirstPoint{d}
\tkzDrawCircle[new](A,C)
\tkzDrawPoints(a,b,c,d,e)
\tkzDrawPolygon(a,b,c,d,e)
\foreach \vertex/\num in {a/36,b/108,c/180,
d/252,e/324}{%
\tkzDrawPoint(\vertex)
\tkzLabelPoint[label=\num:$\vertex$](\vertex){}
\tkzDrawSegment(A,\vertex)
}
\end{tikzpicture}

```

17.3.7. Mix of intersections

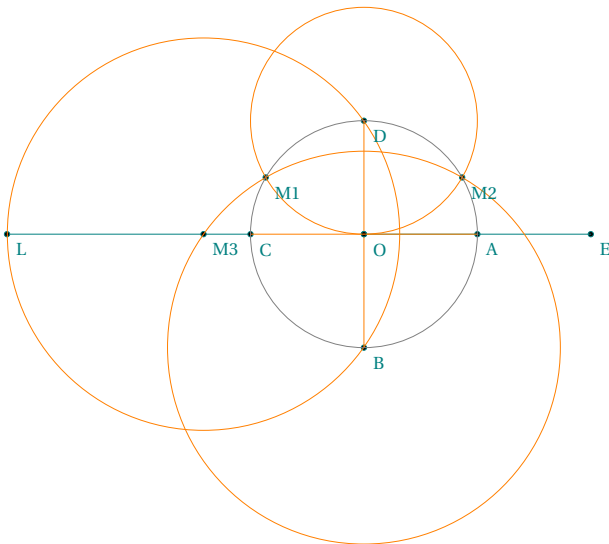

```

\begin{tikzpicture}[scale = .75]
\tkzDefPoint(2,2){A}
\tkzDefPoint(0,0){B}
\tkzDefPoint(-2,2){C}
\tkzDefPoint(0,4){D}
\tkzDefPoint(4,2){E}
\tkzCircumCenter(A,B,C)\tkzGetPoint{O}
\tkzInterCC[R](0,2)(D,2)\tkzGetPoints{M1}{M2}
\tkzInterCC(0,A)(D,0)\tkzGetPoints{1}{2}
\tkzInterLC(A,E)(B,M1)\tkzGetSecondPoint{M3}
\tkzInterLC(0,C)(M3,D)\tkzGetSecondPoint{L}
\tkzDrawSegments(C,L)
\tkzDrawPoints(A,B,C,D,E,M1,M2,M3,O,L)
\tkzDrawSegments(O,E)
\tkzDrawSegments[new](C,A D,B)
\tkzDrawPoint(O)
\tkzDrawCircles[new](M3,D B,M2 D,0)
\tkzDrawCircle(O,A)
\tkzLabelPoints[below right](A,B,C,D,E,M1,M2,M3,O,L)
\end{tikzpicture}

```

17.3.8. Altshiller-Court's theorem

The two lines joining the points of intersection of two orthogonal circles to a point on one of the circles meet the other circle in two diametrically opposite points. Altshiller p 176

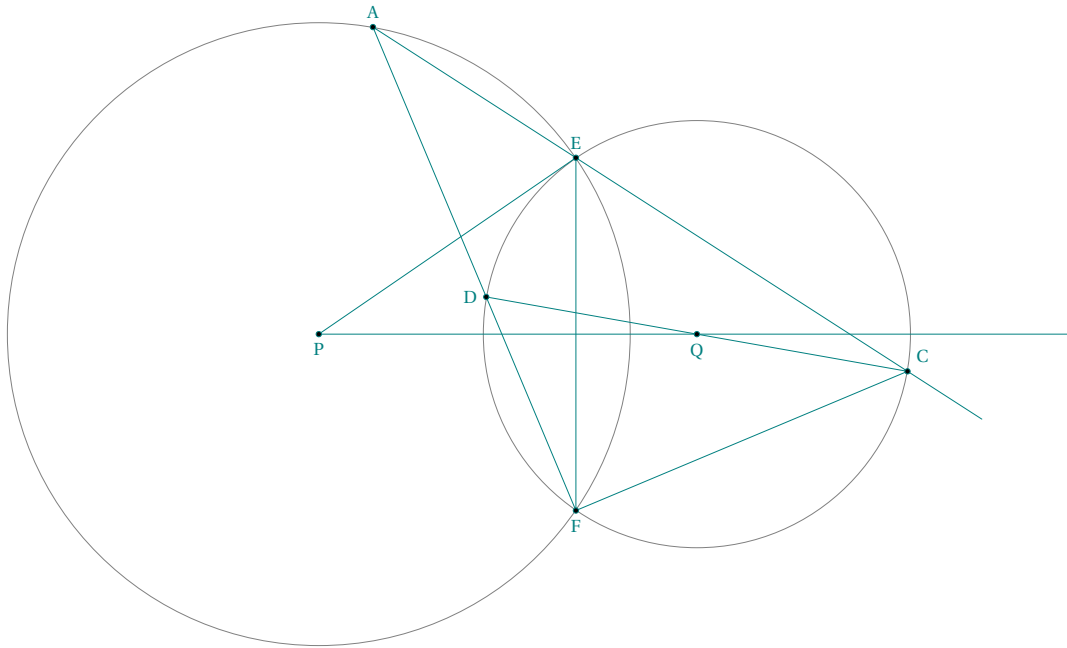

```

\begin{tikzpicture}
  \tkzDefPoints{0/0/P,5/0/Q,3/2/I}
  \tkzDefCircle[orthogonal from=P](Q,I)
  \tkzGetFirstPoint{E}
  \tkzDrawCircles(P,E Q,E)
  \tkzInterCC[common=E](P,E)(Q,E) \tkzGetFirstPoint{F}
  \tkzDefPointOnCircle[through = center P angle 80 point E]
  \tkzGetPoint{A}
  \tkzInterLC[common=E](A,E)(Q,E) \tkzGetFirstPoint{C}
  \tkzInterLL(A,F)(C,Q) \tkzGetPoint{D}
  \tkzDrawLines[add=0 and 1](P,Q)
  \tkzDrawLines[add=0 and 2](A,E)
  \tkzDrawSegments(P,E E,F F,C A,F C,D)
  \tkzDrawPoints(P,Q,E,F,A,C,D)
  \tkzLabelPoints(P,Q,F)
  \tkzLabelPoints[above](E,A)
  \tkzLabelPoints[left](D)
  \tkzLabelPoints[above right](C)
\end{tikzpicture}

```

18. Angles

18.1. Definition and usage with tkz-euclide

In Euclidean geometry, an angle is the figure formed by two rays, called the sides of the angle, sharing a common endpoint, called the vertex of the angle. [Wikipedia]. A ray with `tkz-euclide` is defined by two points also each angle is defined with three points like \widehat{AOB} . The vertex O is the second point. Their order is important because it is assumed that the angle is specified in the direct order (counterclockwise). In trigonometry and mathematics in general, plane angles are conventionally measured counterclockwise, starting with 0° pointing directly to the right (or east), and 90° pointing straight up (or north) [Wikipedia]. Let us agree that an angle measured counterclockwise is positive.

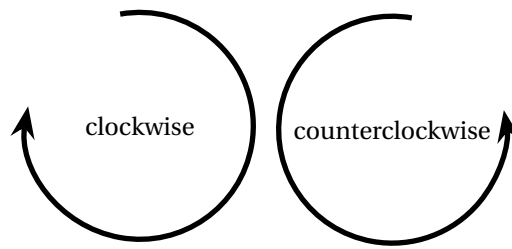

Angles are involved in several macros like `\tkzDefPoint`, `\tkzDefPointBy[rotation = ...]`, `\tkzDrawArc` and the next one `\tkzGetAngle`. With the exception of the last one, all these macros accept negative angles.

<p>Rotation 80° from (O,A) to (O,B) <code>\tkzDefPointBy[rotation=center O angle 80]</code></p>	<p>Rotation -80° from (O,A) to (O,B) <code>\tkzDefPointBy[rotation=center O angle -80]</code></p>
<p><code>\tkzFindAngle(A,O,B)</code> gives 80</p>	<p><code>\tkzFindAngle(A,O,B)</code> gives 280°</p>

As we can see, the -80° rotation defines a clockwise angle but the macro `\tkzFindAngle` recovers a counter-clockwise angle.

18.2. Recovering an angle `\tkzGetAngle`

<code>\tkzGetAngle(<name of macro>)</code>		
Assigns the value in degree of an angle to a macro. The value is positive and between 0° and 360° . This macro retrieves <code>\tkzAngleResult</code> and stores the result in a new macro.		
arguments	example	explanation
name of macro	<code>\tkzGetAngle{ang}</code>	<code>\ang</code> contains the value of the angle.

This is an auxiliary macro that allows you to retrieve the result of the following macro `\tkzFindAngle`.

18.3. Angle formed by three points

<code>\tkzFindAngle(<pt1,pt2,pt3>)</code>		
The result is stored in a macro <code>\tkzAngleResult</code> .		
arguments	example	explanation
(pt1,pt2,pt3)	<code>\tkzFindAngle(A,B,C)</code>	<code>\tkzAngleResult</code> gives the angle $(\overrightarrow{BA}, \overrightarrow{BC})$

The measure is always positive and between 0° and 360° . With the usual conventions, a counterclockwise angle smaller than a straight angle has always a measure between 0° and 180° , while a clockwise angle smaller than a straight angle will have a measurement greater than 180° . `\tkzGetAngle` can retrieve the angle.

18.3.1. Verification of angle measurement

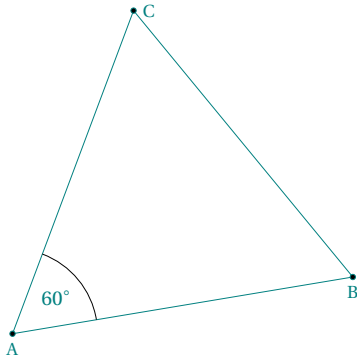

```
\begin{tikzpicture}[scale=.75]
  \tkzDefPoint(-1,1){A}
  \tkzDefPoint(5,2){B}
  \tkzDefEquilateral(A,B)
  \tkzGetPoint{C}
  \tkzDrawPolygon(A,B,C)
  \tkzFindAngle(B,A,C) \tkzGetAngle{angleBAC}
  \edef\angleBAC{\fpeval{round(\angleBAC)}}
  \tkzDrawPoints(A,B,C)
  \tkzLabelPoints(A,B)
  \tkzLabelPoint[right](C){C}
  \tkzLabelAngle(B,A,C){\angleBAC^\circ}
  \tkzMarkAngle[size=1.5](B,A,C)
\end{tikzpicture}
```

18.3.2. Determination of the three angles of a triangle

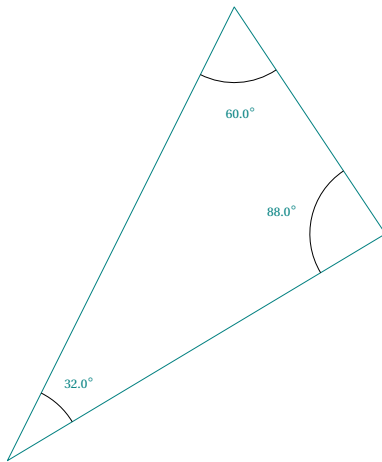

```
\begin{tikzpicture}
  \tikzset{label angle style/.append style={pos=1.4}}
  \tkzDefPoints{0/0/a,5/3/b,3/6/c}
  \tkzDrawPolygon(a,b,c)
  \tkzFindAngle(c,b,a)\tkzGetAngle{angleCBA}
  \pgfmathparse{round(1+\angleCBA)}
  \let\angleCBA\pgfmathresult
  \tkzFindAngle(a,c,b)\tkzGetAngle{angleACB}
  \pgfmathparse{round(\angleACB)}
  \let\angleACB\pgfmathresult
  \tkzFindAngle(b,a,c)\tkzGetAngle{angleBAC}
  \pgfmathparse{round(\angleBAC)}
  \let\angleBAC\pgfmathresult
  \tkzMarkAngle(c,b,a)
  \tkzLabelAngle(c,b,a){\tiny $\angleCBA^\circ$}
  \tkzMarkAngle(a,c,b)
  \tkzLabelAngle(a,c,b){\tiny $\angleACB^\circ$}
  \tkzMarkAngle(b,a,c)
  \tkzLabelAngle(b,a,c){\tiny $\angleBAC^\circ$}
\end{tikzpicture}
```

18.3.3. Angle between two circles

We are looking for the angle formed by the tangents at a point of intersection

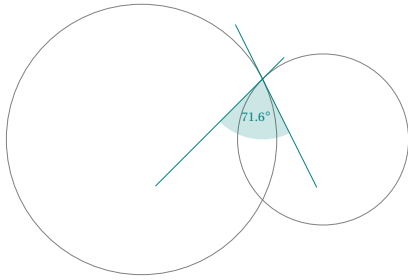

```

\begin{tikzpicture}[scale=.4]
\pgfkeys{/pgf/number format/.cd,%
  fixed,precision=1}
\tkzDefPoints{0/0/A,6/0/B,4/2/C}
\tkzDrawCircles(A,C B,C)
\tkzDefLine[tangent at=C](A)\tkzGetPoint{a}
\tkzDefPointsBy[symmetry=center C](a){d}
\tkzDefLine[tangent at=C](B)\tkzGetPoint{b}
\tkzDrawLines[add=1 and 4](a,C C,b)
\tkzFillAngle[fill=teal,opacity=.2%
  ,size=2](b,C,d)
\tkzFindAngle(b,C,d)\tkzGetAngle{bcd}
\tkzLabelAngle[pos=1.25](b,C,d){%
  \tiny $\pgfmathprintnumber{\bcd}^\circ$}
\end{tikzpicture}

```

18.4. Angle formed by a straight line with the horizontal axis `\tkzFindSlopeAngle`

Much more interesting than the last one. The result is between -180 degrees and +180 degrees.

```
\tkzFindSlopeAngle(<A,B>)
```

Determines the slope of the straight line (AB). The result is stored in a macro `\tkzAngleResult`.

arguments	example	explanation
(pt1,pt2)	<code>\tkzFindSlopeAngle(A,B)</code>	

`\tkzGetAngle` can retrieve the result. If retrieval is not necessary, you can use `\tkzAngleResult`.

18.4.1. How to use `\tkzFindSlopeAngle`

The point here is that (AB) is the bisector of \widehat{CAD} , such that the AD slope is zero. We recover the slope of (AB) and then rotate twice.

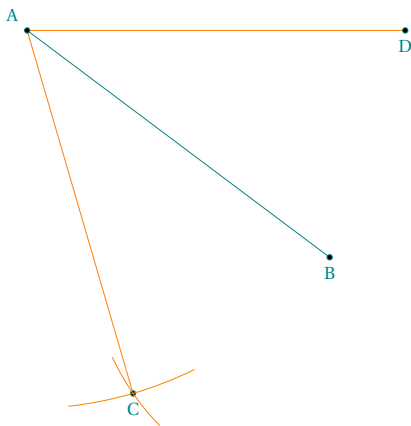

```

\begin{tikzpicture}
\tkzDefPoint(1,5){A}\tkzDefPoint(5,2){B}
\tkzFindSlopeAngle(A,B)\tkzGetAngle{tkzang}
\tkzDefPointBy[rotation=center A angle \tkzang](B)
\tkzGetPoint{C}
\tkzDefPointBy[rotation=center A angle -\tkzang](B)
\tkzGetPoint{D}
\tkzDrawSegment(A,B)
\tkzDrawSegments[new](A,C A,D)
\tkzDrawPoints(A,B,C,D)
\tkzCompass[length=1](A,C)
\tkzCompass[delta=10,brown](B,C)
\tkzLabelPoints(B,C,D)
\tkzLabelPoints[above left](A)
\end{tikzpicture}

```

18.4.2. Use of `\tkzFindSlopeAngle` and `\tkzGetAngle`

Here is another version of the construction of a mediator

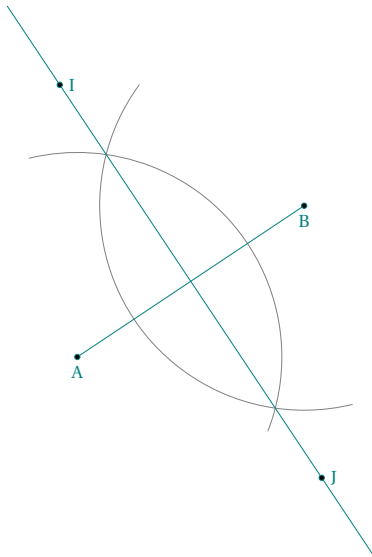

```
\begin{tikzpicture}
\tkzInit
\tkzDefPoint(0,0){A}      \tkzDefPoint(3,2){B}
\tkzDefLine[mediator](A,B) \tkzGetPoints{I}{J}
\tkzCalcLength(A,B)      \tkzGetLength{dAB}
\tkzFindSlopeAngle(A,B)  \tkzGetAngle{tkzangle}
\begin{scope}[rotate=\tkzangle]
\tkzSetUpArc[color=gray,line width=0.2pt,/tkzcompass/delta=10]
\tkzDrawArc[R,arc](B,3/4*\dAB)(120,240)
\tkzDrawArc[R,arc](A,3/4*\dAB)(-45,60)
\tkzDrawLine(I,J)        \tkzDrawSegment(A,B)
\end{scope}
\tkzDrawPoints(A,B,I,J)  \tkzLabelPoints(A,B)
\tkzLabelPoints[right](I,J)
\end{tikzpicture}
```

18.4.3. Another use of \tkzFindSlopeAngle

The slope of (AB) is : 45°

The slope of (AC) is : 0°

The slope of (AD) is : 333.43°

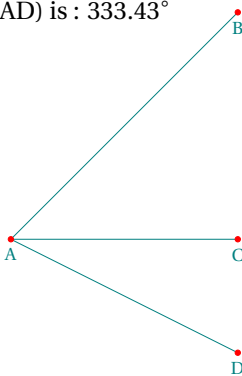

```
\begin{tikzpicture}[scale=1.5]
\tkzDefPoint(1,2){A}      \tkzDefPoint(3,4){B}
\tkzDefPoint(3,2){C}      \tkzDefPoint(3,1){D}
\tkzDrawSegments(A,B A,C A,D)
\tkzDrawPoints[color=red](A,B,C,D)
\tkzLabelPoints(A,B,C,D)
\tkzFindSlopeAngle(A,B)\tkzGetAngle{SAB}
\tkzFindSlopeAngle(A,C)\tkzGetAngle{SAC}
\tkzFindSlopeAngle(A,D)\tkzGetAngle{SAD}
\pgfkeys{/pgf/number format/.cd,fixed,precision=2}
\tkzText(1,5){The slope of (AB) is :
\pgfmathprintnumber{\SAB}^\circ}
\tkzText(1,4.5){The slope of (AC) is :
\pgfmathprintnumber{\SAC}^\circ}
\tkzText(1,4){The slope of (AD) is :
\pgfmathprintnumber{\SAD}^\circ}
\end{tikzpicture}
```

19. Random point definition

At the moment there are four possibilities:

1. point in a rectangle;
2. on a segment;
3. on a straight line;
4. on a circle.

19.1. Obtaining random points

This is the new version that replaces `\tkzGetRandPointOn`.

```
\tkzDefRandPointOn[⟨local options⟩]
```

The result is a point with a random position that can be named with the macro `\tkzGetPoint`. It is possible to use `\tkzPointResult` if it is not necessary to retain the results.

options	default	definition
<code>rectangle=pt1 and pt2</code>		<code>[rectangle=A and B]</code>
<code>segment= pt1--pt2</code>		<code>[segment=A--B]</code>
<code>line=pt1--pt2</code>		<code>[line=A--B]</code>
<code>circle =center pt1 radius dim</code>		<code>[circle = center A radius 2]</code>
<code>circle through=center pt1 through pt2</code>		<code>[circle through= center A through B]</code>
<code>disk through=center pt1 through pt2</code>		<code>[disk through=center A through B]</code>

19.1.1. Random point in a rectangle



```
\begin{tikzpicture}
\tkzDefPoints{0/0/A,5/3/C}
\tkzDefRandPointOn[rectangle = A and C]
\tkzGetPoint{E}
\tkzDefRectangle(A,C)\tkzGetPoints{B}{D}
\tkzDrawPolygon[red](A,...,D)
\tkzDrawPoints(A,...,E)
\tkzLabelPoints(A,B)
\tkzLabelPoints[above](C,D,E)
\end{tikzpicture}
```

19.1.2. Random point on a segment or a line

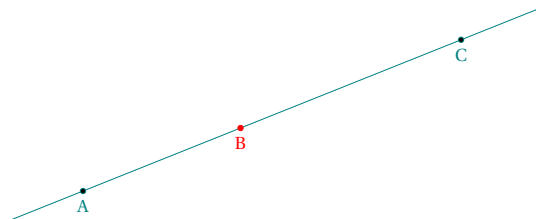

```
\begin{tikzpicture}
\tkzDefPoints{0/0/A,5/2/C}
\tkzDefRandPointOn[segment = A--C]\tkzGetPoint{B}
\tkzDrawLine(A,C)
\tkzDrawPoints(A,C) \tkzDrawPoint[red](B)
\tkzLabelPoints(A,C) \tkzLabelPoints[red](B)
\end{tikzpicture}
```

19.1.3. Random point on a circle or a disk

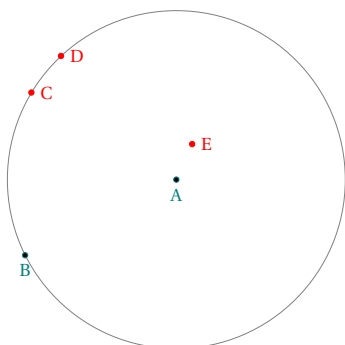

```
\begin{tikzpicture}
\tkzDefPoints{3/2/A,1/1/B}
\tkzCalcLength(A,B) \tkzGetLength{rAB}
\tkzDefRandPointOn[circle = center A radius \rAB]
\tkzGetPoint{C}
\tkzDefRandPointOn[circle through= center A through B]
\tkzGetPoint{D}
\tkzDefRandPointOn[disk through=center A through B]
\tkzGetPoint{E}
\tkzDrawCircle(A,B)
\tkzDrawPoints(A,B)
\tkzLabelPoints(A,B)
\tkzDrawPoints[red](C,D,E)
\tkzLabelPoints[red,right](C,D,E)
\end{tikzpicture}
```

Part IV.

Drawing and Filling

20. Drawing

`tkz-euclide` can draw 5 types of objects : point, line or line segment, circle, arc and sector.

20.1. Draw a point or some points

There are two possibilities : `\tkzDrawPoint` for a single point or `\tkzDrawPoints` for one or more points.

20.1.1. Drawing points `\tkzDrawPoint`

<code>\tkzDrawPoint</code> [<code><local options></code>] (<code><name></code>)		
arguments	default	definition
name of point	no default	Only one point name is accepted
The argument is required. The disc takes the color of the circle, but lighter. It is possible to change everything. The point is a node and therefore it is invariant if the drawing is modified by scaling.		
options	default	definition
TikZ options		all TikZ options are valid.
shape	circle	Possible cross or cross out
size	6	$6 \times \text{\pgflinewidth}$
color	black	the default color can be changed
We can create other forms such as cross		

By default, `point style` is defined like this :

```
\tikzset{point style/.style = {%
    draw      = black,
    inner sep = 0pt,
    shape     = circle,
    minimum size = 3 pt,
    fill      = black
  }
}
```

20.1.2. Example of point drawings

Note that `scale` does not affect the shape of the dots. Which is normal. Most of the time, we are satisfied with a single point shape that we can define from the beginning, either with a macro or by modifying a configuration file.

```
\begin{tikzpicture}[scale=.5]
  \tkzDefPoint(1,3){A}
  \tkzDefPoint(4,1){B}
  \tkzDefPoint(0,0){O}
  \tkzDrawPoint[color=red](A)
  \tkzDrawPoint[fill=blue!20,draw=blue](B)
  \tkzDrawPoint[shape=cross,size=8pt,color=teal](O)
\end{tikzpicture}
```

It is possible to draw several points at once but this macro is a little slower than the previous one. Moreover, we have to make do with the same options for all the points.

```
\tkzDrawPoints[⟨local options⟩](⟨liste⟩)
```

arguments	default	definition
points list	no default	example <code>\tkzDrawPoints(A,B,C)</code>
options	default	definition
shape	circle	Possible cross or cross out
size	6	$6 \times \text{\pgflinewidth}$
color	black	the default color can be changed

 Beware of the final "s", an oversight leads to cascading errors if you try to draw multiple points. The options are the same as for the previous macro.

20.1.3. Example

```

\begin{tikzpicture}
\tkzDefPoints{1/3/A,4/1/B,0/0/C}
\tkzDrawPoints[size=3,color=red,fill=red!50](A,B,C)
\end{tikzpicture}

```



21. Drawing the lines

The following macros are simply used to draw, name lines.

21.1. Draw a straight line

To draw a normal straight line, just give a couple of points. You can use the `add` option to extend the line (This option is due to **Mark Wibrow**, see the code below).

The style of a line is by default :

```

\tikzset{line style/.style = {%
  line width = 0.6pt,
  color      = black,
  style      = solid,
  add       = {.2} and {.2}%
}}

```

with

```

\tikzset{%
  add/.style args={#1 and #2}{
    to path={%
      ($(\tikztostart)!-#1!(\tikztotarget)$)--($(\tikztotarget)!-#2!(\tikztostart)$)%
      \tikztonodes}}
}

```

You can modify this style with `\tkzSetUpLine` see 38.1

`\tkzDrawLine[⟨local options⟩](⟨pt1,pt2⟩)`

The arguments are a list of two points or three points. It would be possible, as for a half line, to create a style with `\add`.

options	default	definition
TikZ options		all TikZ options are valid.
add	0.2 and 0.2	add = kl and kr, ...
...	...	allows the segment to be extended to the left and right.

`add` defines the length of the line passing through the points `pt1` and `pt2`. Both numbers are percentages. The styles of TikZ are accessible for plots.

21.1.1.1. Examples with add

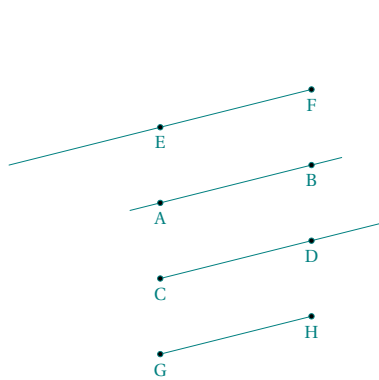

```
\begin{tikzpicture}
\tkzInit[xmin=-2,xmax=3,ymin=-2.25,ymax=2.25]
\tkzClip[space=.25]
\tkzDefPoint(0,0){A} \tkzDefPoint(2,0.5){B}
\tkzDefPoint(0,-1){C} \tkzDefPoint(2,-0.5){D}
\tkzDefPoint(0,1){E} \tkzDefPoint(2,1.5){F}
\tkzDefPoint(0,-2){G} \tkzDefPoint(2,-1.5){H}
\tkzDrawLine(A,B) \tkzDrawLine[add = 0 and .5](C,D)
\tkzDrawLine[add = 1 and 0](E,F)
\tkzDrawLine[add = 0 and 0](G,H)
\tkzDrawPoints(A,B,C,D,E,F,G,H)
\tkzLabelPoints(A,B,C,D,E,F,G,H)
\end{tikzpicture}
```

It is possible to draw several lines, but with the same options.

`\tkzDrawLines[⟨local options⟩](⟨pt1,pt2 pt3,pt4 ...⟩)`

Arguments are a list of pairs of points separated by spaces. The styles of TikZ are available for the draws.

21.1.1.2. Example with \tkzDrawLines

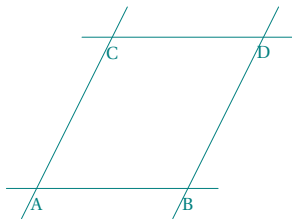

```
\begin{tikzpicture}
\tkzDefPoint(0,0){A}
\tkzDefPoint(2,0){B}
\tkzDefPoint(1,2){C}
\tkzDefPoint(3,2){D}
\tkzDrawLines(A,B C,D A,C B,D)
\tkzLabelPoints(A,B,C,D)
\end{tikzpicture}
```

22. Drawing a segment

There is, of course, a macro to simply draw a segment.

22.1. Draw a segment \tkzDrawSegment

```
\tkzDrawSegment[⟨local options⟩](⟨pt1,pt2⟩)
```

The arguments are a list of two points. The styles of TikZ are available for the drawings.

argument	example	definition
(pt1,pt2)	(A,B)	draw the segment [A,B]
options	example	definition
TikZ options		all TikZ options are valid.
dim	no default	dim = {label,dim,option}, ...
...	...	allows you to add dimensions to a figure.

This is of course equivalent to `\draw (A)--(B)`; You can also use the option `add`.

22.1.1. Example with point references

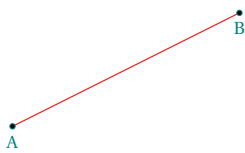

```
\begin{tikzpicture}[scale=1.5]
\tkzDefPoint(0,0){A}
\tkzDefPoint(2,1){B}
\tkzDrawSegment[color=red,thin](A,B)
\tkzDrawPoints(A,B)
\tkzLabelPoints(A,B)
\end{tikzpicture}
```

22.1.2. Example of extending an segment with option add

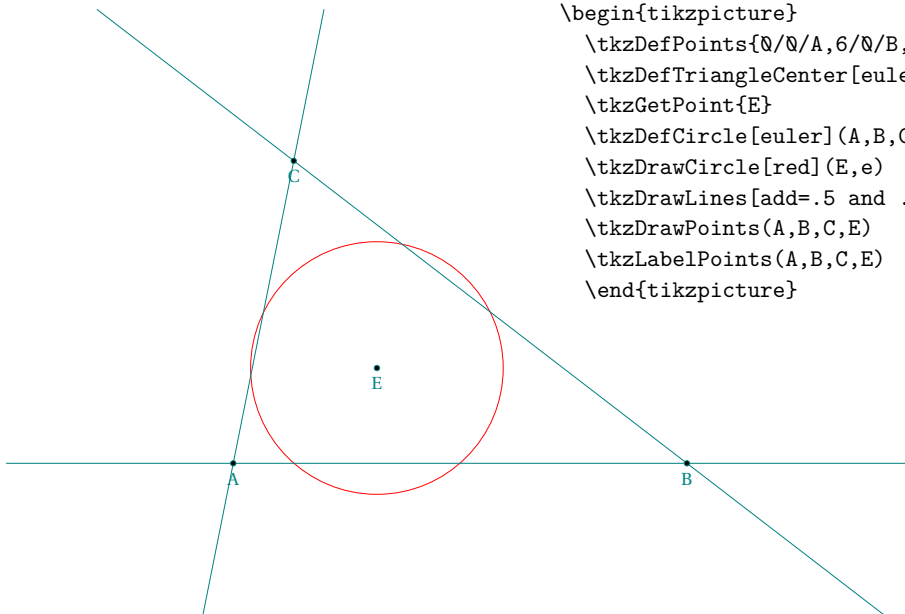

```
\begin{tikzpicture}
\tkzDefPoints{0/0/A,6/0/B,0.8/4/C}
\tkzDefTriangleCenter[euler](A,B,C)
\tkzGetPoint{E}
\tkzDefCircle[euler](A,B,C)\tkzGetPoints{E}{e}
\tkzDrawCircle[red](E,e)
\tkzDrawLines[add=.5 and .5](A,B A,C B,C)
\tkzDrawPoints(A,B,C,E)
\tkzLabelPoints(A,B,C,E)
\end{tikzpicture}
```

22.1.3. Adding dimensions with option dim new code from Muzimuzhi Z

This code comes from an answer to this question on [tex.stackexchange.com](https://tex.stackexchange.com/questions/444444/change-color-and-style-of-dimension-lines-in-tikz-euclide) (change-color-and-style-of-dimension-lines-in-tikz-euclide). The code of `dim` is based on options of TikZ, you must add the units. You can use now two styles: `dim style` and `dim fence style`. You have several ways to use them. I'll let you look at the examples to see what you can do with these styles.

```
\tikzset{dim style/.append style={dashed}} % append if you want to keep precedent style.
or
\begin{scope}[ dim style/.append style={orange},
  dim fence style/.style={dashed}]
```

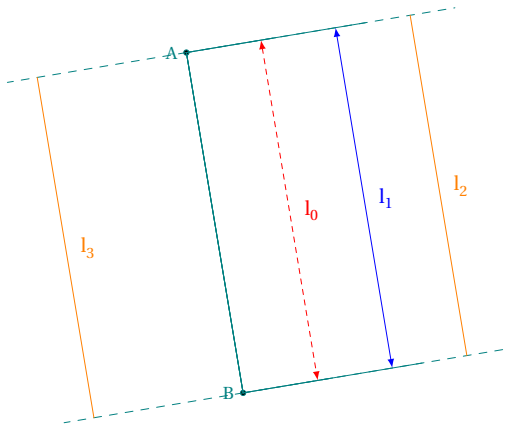

```
\begin{tikzpicture}[scale=.75]
\tkzDefPoints{0/3/A, 1/-3/B}
\tkzDrawPoints(A,B)
\tkzDrawSegment[dim={\l_0},1cm,right=2mm],
  dim style/.append style={red,
  dash pattern={on 2pt off 2pt}}](A,B)
\tkzDrawSegment[dim={\l_1},2cm,right=2mm],
  dim style/.append style={blue}](A,B)
\begin{scope}[ dim style/.style={orange},
  dim fence style/.style={dashed}]
\tkzDrawSegment[dim={\l_2},3cm,right=2mm](A,B)
\tkzDrawSegment[dim={\l_3},-2cm,right=2mm](A,B)
\end{scope}
\tkzLabelPoints[left](A,B)
\end{tikzpicture}
```

22.1.4. Adding dimensions with option dim partI

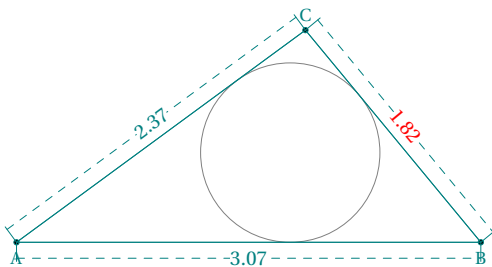

```
\begin{tikzpicture}[scale=2]
\pgfkeys{/pgf/number format/.cd, fixed, precision=2}
\tkzDefPoint(0,0){A}
\tkzDefPoint(3.07,0){B}
\tkzInterCC[R](A,2.37)(B,1.82)
\tkzGetPoints{C}{C'}
\tkzDefCircle[in](A,B,C) \tkzGetPoints{G}{g}
\tkzDrawCircle(G,g)
\tkzDrawPolygon(A,B,C)
\tkzDrawPoints(A,B,C)
\tkzCalcLength(A,B)\tkzGetLength{ABl}
\tkzCalcLength(B,C)\tkzGetLength{BCl}
\tkzCalcLength(A,C)\tkzGetLength{ACl}
\begin{scope}[dim style/.style={dashed,sloped,teal}]
\tkzDrawSegment[dim={\pgfmathprintnumber\BCl,6pt,
  text=red}](C,B)
\tkzDrawSegment[dim={\pgfmathprintnumber\ACl,6pt,}](A,C)
\tkzDrawSegment[dim={\pgfmathprintnumber\ABl,-
  6pt,}](A,B)
\end{scope}
\tkzLabelPoints(A,B) \tkzLabelPoints[above](C)
\end{tikzpicture}
```

22.1.5. Adding dimensions with option dim part II

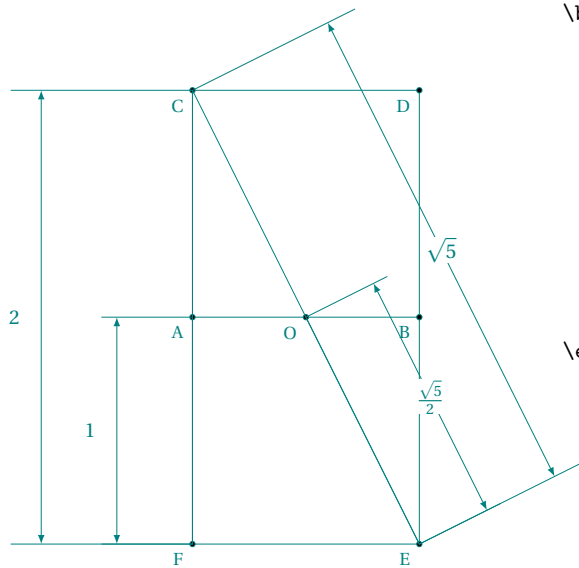

```
\begin{tikzpicture}[scale=.75]
  \tkzDefPoints{0/0/O,-2/0/A,2/0/B,
    -2/4/C,2/4/D,2/-4/E,-2/-4/F}
  \tkzDrawPolygon(C,...,F)
  \tkzDrawSegments(A,B)
  \tkzDrawPoints(A,...,F,O)
  \tkzLabelPoints[below left](A,...,F,O)
  \tkzDrawSegment[dim={ $\sqrt{5}$,2cm,}] (C,E)
  \tkzDrawSegment[dim={ $\frac{\sqrt{5}}{2}$,1cm,}] (O,E)
  \tkzDrawSegment[dim={ $2$,2cm,left=8pt}] (F,C)
  \tkzDrawSegment[dim={ $1$,1cm,left=8pt}] (F,A)
\end{tikzpicture}
```

22.2. Drawing segments \tkzDrawSegments

If the options are the same we can plot several segments with the same macro.

```
\tkzDrawSegments[<local options>](\pt1,pt2 \pt3,pt4 ...)
```

The arguments are a two-point couple list. The styles of TikZ are available for the plots.

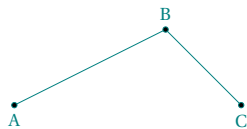

```
\begin{tikzpicture}
  \tkzInit[xmin=-1,xmax=3,ymin=-1,ymax=2]
  \tkzClip[space=1]
  \tkzDefPoint(0,0){A}
  \tkzDefPoint(2,1){B}
  \tkzDefPoint(3,0){C}
  \tkzDrawSegments(A,B B,C)
  \tkzDrawPoints(A,B,C)
  \tkzLabelPoints(A,C)
  \tkzLabelPoints[above](B)
\end{tikzpicture}
```

22.2.1. Place an arrow on segment

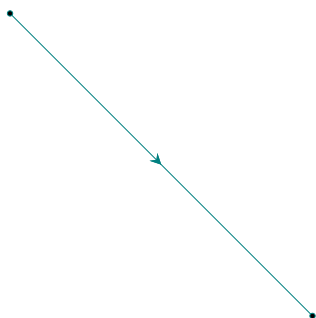

```
\begin{tikzpicture}
  \tkzSetUpStyle[postaction=decorate,
    decoration={markings,
    mark=at position .5 with {\arrow[thick]{#1}}
    }]{myarrow}
  \tkzDefPoint(0,0){A}
  \tkzDefPoint(4,-4){B}
  \tkzDrawSegments[myarrow=stealth](A,B)
  \tkzDrawPoints(A,B)
\end{tikzpicture}
```

22.3. Drawing line segment of a triangle

22.3.1. How to draw Altitude

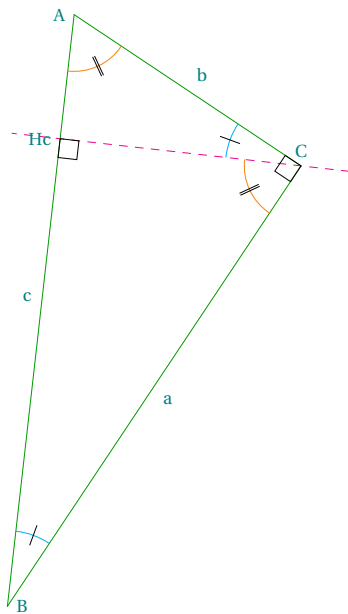

```

\begin{tikzpicture}[rotate=-90]
\tkzDefPoint(0,1){A}
\tkzDefPoint(2,4){C}
\tkzDefPointWith[orthogonal normed,K=7](C,A)
\tkzGetPoint{B}
\tkzDefSpcTriangle[orthic,name=H](A,B,C){a,b,c}
\tkzDrawLine[dashed,color=magenta](C,Hc)
\tkzDrawSegment[green!60!black](A,C)
\tkzDrawSegment[green!60!black](C,B)
\tkzDrawSegment[green!60!black](B,A)
\tkzLabelPoint[left](A){$A$}
\tkzLabelPoint[right](B){$B$}
\tkzLabelPoint[above](C){$C$}
\tkzLabelPoint[left](Hc){$Hc$}
\tkzLabelSegment[auto](B,A){$c$}
\tkzLabelSegment[auto,swap](B,C){$a$}
\tkzLabelSegment[auto,swap](C,A){$b$}
\tkzMarkAngle[size=1,color=cyan,mark=|](C,B,A)
\tkzMarkAngle[size=1,color=cyan,mark=|](A,C,Hc)
\tkzMarkAngle[size=0.75,
color=orange,mark=|](Hc,C,B)
\tkzMarkAngle[size=0.75,
color=orange,mark=|](B,A,C)
\tkzMarkRightAngle(A,C,B)
\tkzMarkRightAngle(B,Hc,C)
\end{tikzpicture}

```

22.4. Drawing a polygon

```
\tkzDrawPolygon[local options](points list)
```

Just give a list of points and the macro plots the polygon using the TikZ options present. You can replace (A,B,C,D,E) by (A,...,E) and (P₁,P₂,P₃,P₄,P₅) by (P₁,P_{...},P₅)

arguments	example	explanation
(pt1,pt2,pt3,...)	<code>\tkzDrawPolygon[gray,dashed](A,B,C)</code>	Drawing a triangle
options	default	example
Options TikZ ...		<code>\tkzDrawPolygon[red,line width=2pt](A,B,C)</code>

22.4.1. \tkzDrawPolygon

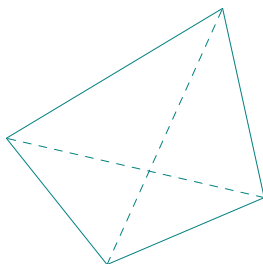

```

\begin{tikzpicture}[rotate=18,scale=1]
\tkzDefPoints{0/0/A,2.25/0.2/B,2.5/2.75/C,-0.75/2/D}
\tkzDrawPolygon(A,B,C,D)
\tkzDrawSegments[style=dashed](A,C B,D)
\end{tikzpicture}

```

22.4.2. Option two angles

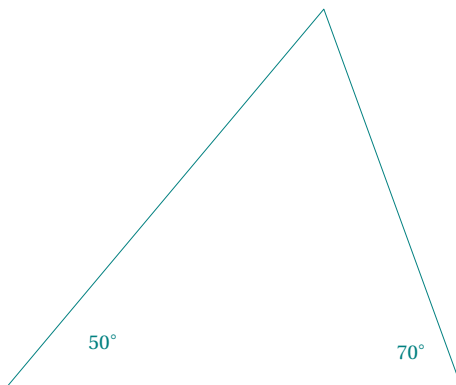

```
\begin{tikzpicture}
\tkzDefPoint(0,0){A}
\tkzDefPoint(6,0){B}
\tkzDefTriangle[two angles = 50 and 70](A,B) \tkzGetPoint{C}
\tkzDrawPolygon(A,B,C)
\tkzLabelAngle[pos=1.4](B,A,C){$50^\circ$}
\tkzLabelAngle[pos=0.8](C,B,A){$70^\circ$}
\end{tikzpicture}
```

22.4.3. Style of line



```
\begin{tikzpicture}[scale=.6]
\tkzSetUpLine[line width=5mm,color=teal]
\tkzDefPoint(0,0){0}
\foreach \i in {0,...,5}{%
\tkzDefPoint({30+60*\i}:4){p\i}}
\tkzDefMidPoint(p1,p3) \tkzGetPoint{m1}
\tkzDefMidPoint(p3,p5) \tkzGetPoint{m3}
\tkzDefMidPoint(p5,p1) \tkzGetPoint{m5}
\tkzDrawPolygon[line join=round](p1,p3,p5)
\tkzDrawPolygon[teal!80,
line join=round](p0,p2,p4)
\tkzDrawSegments(m1,p3 m3,p5 m5,p1)
\tkzDefCircle[R](0,4.8)\tkzGetPoint{o}
\tkzDrawCircle[teal](0,o)
\end{tikzpicture}
```

22.5. Drawing a polygonal chain

```
\tkzDrawPolySeg[⟨local options⟩](⟨points list⟩)
```

Just give a list of points and the macro plots the polygonal chain using the TikZ options present.

arguments	example	explanation
(⟨pt1,pt2,pt3,...⟩)	\tkzDrawPolySeg[gray,dashed](A,B,C)	Drawing a triangle
options	default	example
Options TikZ ...		\tkzDrawPolySeg[red,line width=2pt](A,B,C)

22.5.1. Polygonal chain

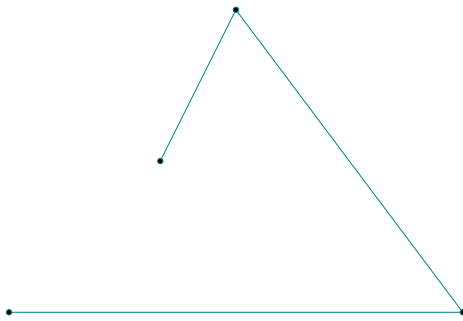

```
\begin{tikzpicture}
\tkzDefPoints{0/0/A,6/0/B,3/4/C,2/2/D}
\tkzDrawPolySeg(A,...,D)
\tkzDrawPoints(A,...,D)
\end{tikzpicture}
```

22.5.2. The idea is to inscribe two squares in a semi-circle.

A Sangaku look! It is a question of proving that one can inscribe in a half-disc, two squares, and to determine the length of their respective sides according to the radius.

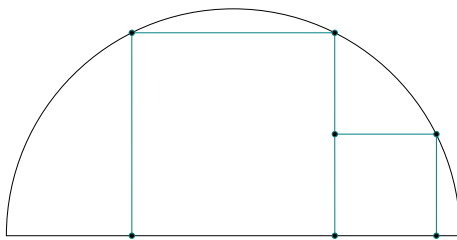

```
\begin{tikzpicture}[scale=.75]
\tkzDefPoints{0/0/A,8/0/B,4/0/I}
\tkzDefSquare(A,B) \tkzGetPoints{C}{D}
\tkzInterLC(I,C)(I,B) \tkzGetPoints{E'}{E}
\tkzInterLC(I,D)(I,B) \tkzGetPoints{F'}{F}
\tkzDefPointsBy[projection=onto A--B](E,F){H,G}
\tkzDefPointsBy[symmetry=center H](I){J}
\tkzDefSquare(H,J) \tkzGetPoints{K}{L}
\tkzDrawSector(I,B)(A)
\tkzDrawPolySeg(H,E,F,G)
\tkzDrawPolySeg(J,K,L)
\tkzDrawPoints(E,G,H,F,J,K,L)
\end{tikzpicture}
```

22.5.3. Polygonal chain: index notation

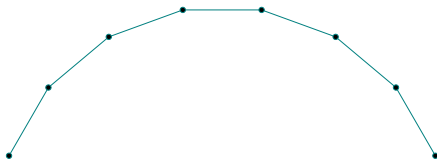

```
\begin{tikzpicture}
\foreach \pt in {1,2,...,8} {%
\tkzDefPoint(\pt*20:3){P_\pt}}
\tkzDrawPolySeg(P_1,P_...,P_8)
\tkzDrawPoints(P_1,P_...,P_8)
\end{tikzpicture}
```

23. Draw a circle with `\tkzDrawCircle`

23.1. Draw one circle

```
\tkzDrawCircle[(local options)](<A,B>)
```

 Attention you need only two points to define a radius. An additional option **R** is available to give a measure directly.

arguments	example	explanation
<code><pt1,pt2></code>	<code><A,B></code>	A center through B

Of course, you have to add all the styles of TikZ for the tracings...

23.1.1. Circles and styles, draw a circle and color the disc

We'll see that it's possible to colour in a disc while tracing the circle.

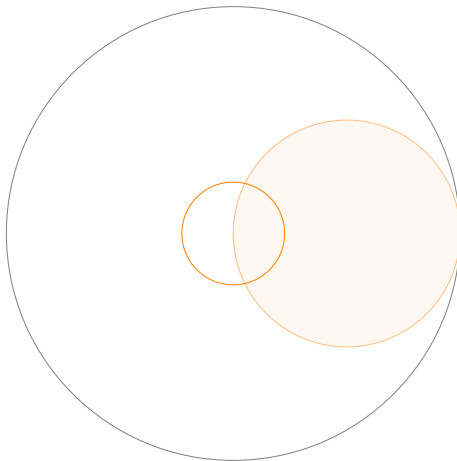

```
\begin{tikzpicture}
  \tkzDefPoint(0,0){O}
  \tkzDefPoint(3,0){A}
  % circle with center O and passing through A
  \tkzDrawCircle(O,A)
  % diameter circle  $[OA]$ 
  \tkzDefCircle[diameter](O,A) \tkzGetPoint{I}
  \tkzDrawCircle[new,fill=orange!10,opacity=.5](I,A)
  % circle with center O and radius =  $\exp(1)$  cm
  \edef\rayon{\fpeval{0.25*\exp(1)}}
  \tkzDefCircle[R](O,\rayon) \tkzGetPoint{o}
  \tkzDrawCircle[color=orange](O,o)
\end{tikzpicture}
```

23.2. Drawing circles

```
\tkzDrawCircles[⟨local options⟩](⟨A,B C,D ...⟩)
```

Attention, the arguments are lists of two points. The circles that can be drawn are the same as in the previous macro. An additional option **R** is available to give a measure directly.

arguments	example	explanation
<code>(⟨pt1,pt2 pt3,pt4 ...⟩)</code>	<code>(⟨A,B C,D⟩)</code>	List of two points
options	default	definition
<code>through</code>	<code>through</code>	circle with two points defining a radius

You do not need to use the default option **through**. Of course, you have to add all the styles of TikZ for the tracings...

23.2.1. Circles defined by a triangle.

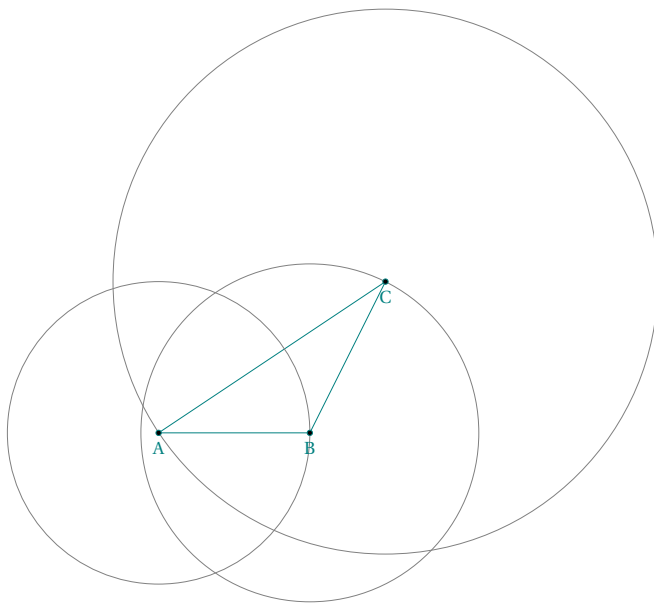

```

\begin{tikzpicture}
  \tkzDefPoints{0/0/A,2/0/B,3/2/C}
  \tkzDrawPolygon(A,B,C)
  \tkzDrawCircles(A,B B,C C,A)
  \tkzDrawPoints(A,B,C)
  \tkzLabelPoints(A,B,C)
\end{tikzpicture}

```

23.2.2. Concentric circles.

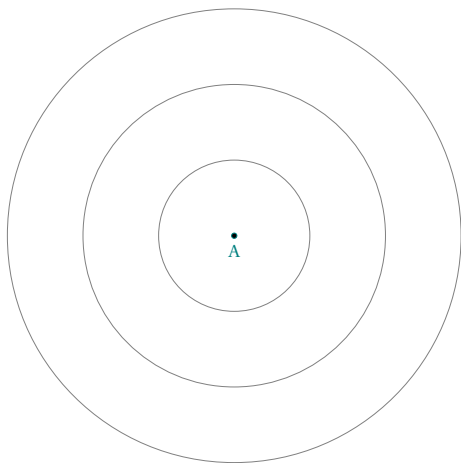

```

\begin{tikzpicture}
  \tkzDefPoints{0/0/A,1/0/a,2/0/b,3/0/c}
  \tkzDrawCircles(A,a A,b A,c)
  \tkzDrawPoint(A)
  \tkzLabelPoints(A)
\end{tikzpicture}

```

23.2.3. Exinscribed circles.

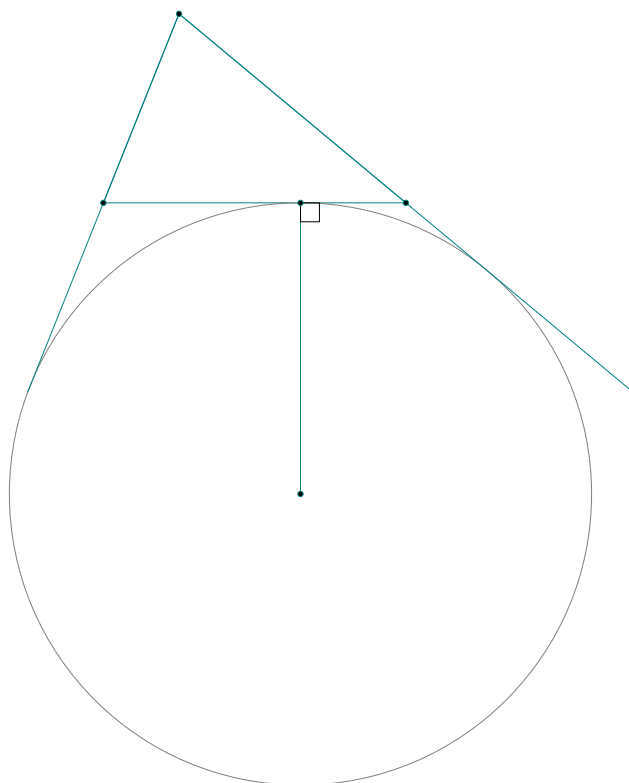

```

\begin{tikzpicture}[scale=1]
\tkzDefPoints{0/0/A,4/0/B,1/2.5/C}
\tkzDrawPolygon(A,B,C)
\tkzDefCircle[ex](B,C,A)
\tkzGetPoint{J_c} \tkzGetSecondPoint{T_c}
\tkzDrawCircle(J_c,T_c)
\tkzDrawLines[add=0 and 1](C,A C,B)
\tkzDrawSegment(J_c,T_c)
\tkzMarkRightAngle(J_c,T_c,B)
\tkzDrawPoints(A,B,C,J_c,T_c)
\end{tikzpicture}

```

23.2.4. Cardioid

Based on an idea by O. Rebourg made with `pst-eucl` (Pstricks module) by D. Rodriguez.

Its name comes from the Greek *kardia* (*heart*), in reference to its shape, and was given to it by Johan Castillon (Wikipedia).

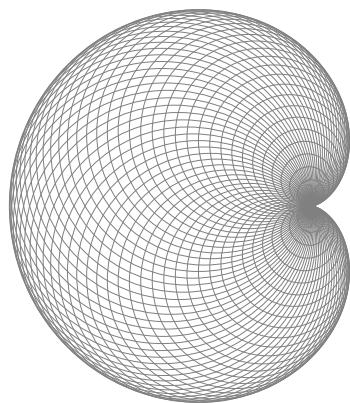

```

\begin{tikzpicture}[scale=.5]
\tkzDefPoint(0,0){O}
\tkzDefPoint(2,0){A}
\foreach \ang in {5,10,...,360}{%
\tkzDefPoint(\ang:2){M}
\tkzDrawCircle(M,A)
}
\end{tikzpicture}

```

23.3. Drawing semicircle

<code>\tkzDrawSemiCircle[⟨local options⟩](⟨O,A⟩)</code>

arguments	example	explanation
<code>(⟨pt1,pt2⟩)</code>	<code>(⟨O,A⟩)</code>	OA= radius
	O center A extremity of the semicircle	

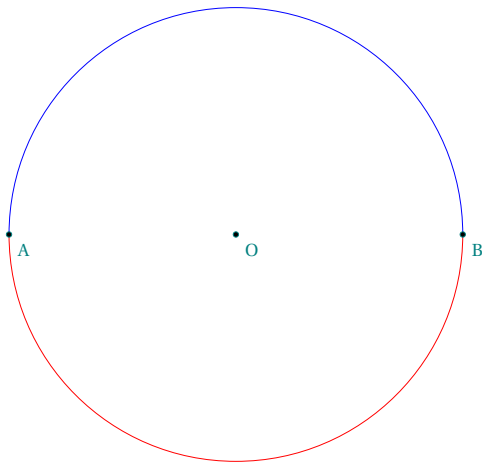
23.3.1. Use of `\tkzDrawSemiCircle`

```

\begin{tikzpicture}
\tkzDefPoint(0,0){A} \tkzDefPoint(6,0){B}
\tkzDefMidPoint(A,B) \tkzGetPoint{O}
\tkzDrawSemiCircle[blue](O,B)
\tkzDrawSemiCircle[red](O,A)
\tkzDrawPoints(O,A,B)
\tkzLabelPoints[below right](O,A,B)
\end{tikzpicture}

```

23.4. Drawing semicircles

<code>\tkzDrawSemiCircles[⟨local options⟩](⟨A,B C,D ...⟩)</code>
--

arguments	example	explanation
<code>(⟨pt1,pt2 pt3,pt4 ...⟩)</code>	<code>(⟨A,B C,D⟩)</code>	List of two points

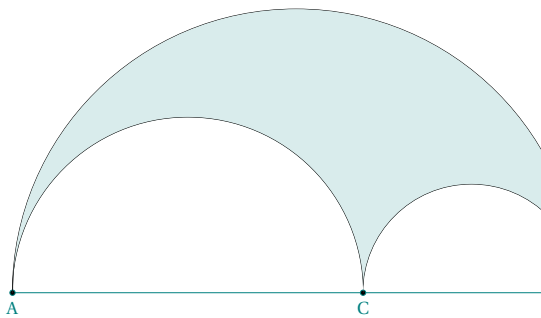
23.4.1. Use of `\tkzDrawSemiCircles` : Golden arbelos

```

\begin{tikzpicture}[scale=.75]
\tkzDefPoints{0/0/A,10/0/B}
\tkzDefGoldenRatio(A,B) \tkzGetPoint{C}
\tkzDefMidPoint(A,B) \tkzGetPoint{O_0}
\tkzDefMidPoint(A,C) \tkzGetPoint{O_1}
\tkzDefMidPoint(C,B) \tkzGetPoint{O_2}
\tkzLabelPoints(A,B,C)
\tkzDrawSegment(A,B)
\tkzDrawPoints(A,B,C)
\begin{scope}[local bounding box = graph]
\tkzDrawSemiCircles[color=black](O_0,B)
\end{scope}
\useasboundingbox (graph.south west) rectangle (graph.north east);
\tkzClipCircle[out](O_1,C)\tkzClipCircle[out](O_2,B)
\tkzDrawSemiCircles[draw=none,fill=teal!15](O_0,B)
\tkzDrawSemiCircles[color=black](O_1,C O_2,B)
\end{tikzpicture}

```

24. Drawing arcs

24.1. Macro: `\tkzDrawArc`

```
\tkzDrawArc[⟨local options⟩](⟨O,...⟩)(⟨...⟩)
```

This macro traces the arc of center O. Depending on the options, the arguments differ. It is a question of determining a starting point and an end point. Either the starting point is given, which is the simplest, or the radius of the arc is given. In the latter case, it is necessary to have two angles. Either the angles can be given directly, or nodes associated with the center can be given to determine them. The angles are in degrees.

options	default	definition
towards	towards	O is the center and the arc from A to (OB)
rotate	towards	the arc starts from A and the angle determines its length
R	towards	We give the radius and two angles
R with nodes	towards	We give the radius and two points
angles	towards	We give the radius and two points
delta	0	angle added on each side
reverse	false	inversion of the arc's path, interesting to inverse arrow

Of course, you have to add all the styles of TikZ for the tracings...

options	arguments	example
towards	(⟨pt,pt⟩)(⟨pt⟩)	<code>\tkzDrawArc[delta=10](O,A)(B)</code>
rotate	(⟨pt,pt⟩)(⟨an⟩)	<code>\tkzDrawArc[rotate,color=red](O,A)(90)</code>
R	(⟨pt,r⟩)(⟨an,an⟩)	<code>\tkzDrawArc[R](O,2)(30,90)</code>
R with nodes	(⟨pt,r⟩)(⟨pt,pt⟩)	<code>\tkzDrawArc[R with nodes](O,2)(A,B)</code>
angles	(⟨pt,pt⟩)(⟨an,an⟩)	<code>\tkzDrawArc[angles](O,A)(0,90)</code>

Here are a few examples:

24.1.1.1. Option `towards`

It's useless to put `towards`. In this first example the arc starts from A and goes to B. The arc going from B to A is different. The salient is obtained by going in the direct direction of the trigonometric circle.

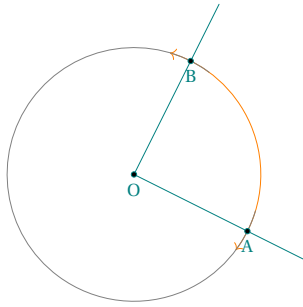

```
\begin{tikzpicture}[scale=.75]
  \tkzDefPoint(0,0){O}
  \tkzDefPoint(2,-1){A}
  \tkzDefPointBy[rotation= center O angle 90](A)
  \tkzGetPoint{B}
  \tkzDrawArc[color=orange,<->](O,A)(B)
  \tkzDrawArc(O,B)(A)
  \tkzDrawLines[add = 0 and .5](O,A O,B)
  \tkzDrawPoints(O,A,B)
  \tkzLabelPoints[below](O,A,B)
\end{tikzpicture}
```

24.1.2. Option towards

In this one, the arc starts from A but stops on the right (OB).

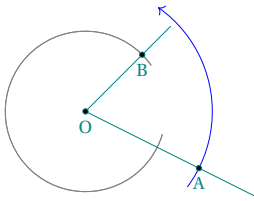

```
\begin{tikzpicture}[scale=0.75]
  \tkzDefPoint(0,0){O}
  \tkzDefPoint(2,-1){A}
  \tkzDefPoint(1,1){B}
  \tkzDrawArc[color=blue,->](O,A)(B)
  \tkzDrawArc[color=gray](O,B)(A)
  \tkzDrawArc(O,B)(A)
  \tkzDrawLines[add = 0 and .5](O,A O,B)
  \tkzDrawPoints(O,A,B)
  \tkzLabelPoints[below](O,A,B)
\end{tikzpicture}
```

24.1.3. Option rotate

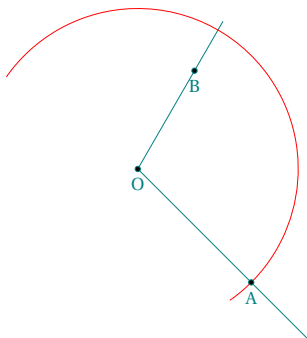

```
\begin{tikzpicture}[scale=0.75]
  \tkzDefPoint(0,0){O}
  \tkzDefPoint(2,-2){A}
  \tkzDefPoint(60:2){B}
  \tkzDrawLines[add = 0 and .5](O,A O,B)
  \tkzDrawArc[rotate,color=red](O,A)(180)
  \tkzDrawPoints(O,A,B)
  \tkzLabelPoints[below](O,A,B)
\end{tikzpicture}
```

24.1.4. Option R

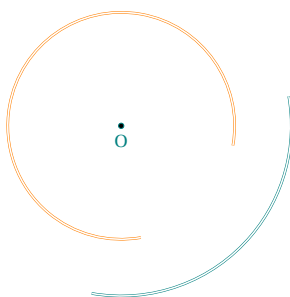

```
\begin{tikzpicture}[scale=0.75]
  \tkzDefPoints{0/0/0}
  \tkzSetUpCompass[<->]
  \tkzDrawArc[R,color=teal,double](0,3)(270,360)
  \tkzDrawArc[R,color=orange,double](0,2)(0,270)
  \tkzDrawPoint(O)
  \tkzLabelPoint[below](O){$O$}
\end{tikzpicture}
```

24.1.5. Option R with nodes

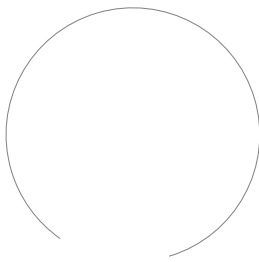

```
\begin{tikzpicture}[scale=0.75]
  \tkzDefPoint(0,0){O}
  \tkzDefPoint(2,-1){A}
  \tkzDefPoint(1,1){B}
  \tkzCalcLength(B,A)\tkzGetLength{radius}
  \tkzDrawArc[R with nodes](B,\radius)(A,O)
\end{tikzpicture}
```

24.1.6. Option delta

This option allows a bit like `\tkzCompass` to place an arc and overflow on either side. `delta` is a measure in degrees.

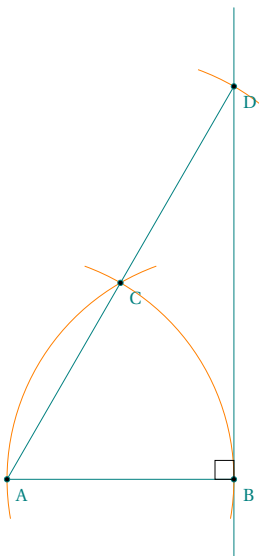

```
\begin{tikzpicture}
  \tkzDefPoint(0,0){A}
  \tkzDefPoint(3,0){B}
  \tkzDefPointBy[rotation= center A angle 60](B)
  \tkzGetPoint{C}
  \begin{scope}% style only local
    \tkzDefPointBy[symmetry= center C](A)
    \tkzGetPoint{D}
    \tkzDrawSegments(A,B A,D)
    \tkzDrawLine(B,D)
    \tkzSetUpCompass[color=orange]
    \tkzDrawArc[orange,delta=10](A,B)(C)
    \tkzDrawArc[orange,delta=10](B,C)(A)
    \tkzDrawArc[orange,delta=10](C,D)(D)
  \end{scope}

  \tkzDrawPoints(A,B,C,D)
  \tkzLabelPoints[below right](A,B,C,D)
  \tkzMarkRightAngle(D,B,A)
\end{tikzpicture}
```

24.1.7. Option angles: example 1

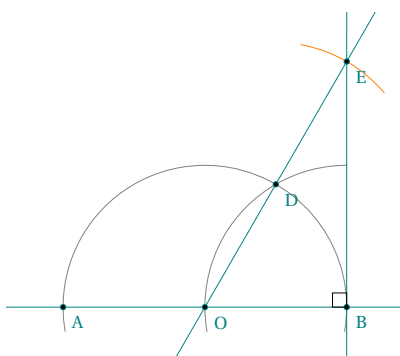

```
\begin{tikzpicture}[scale=.75]
  \tkzDefPoint(0,0){A}
  \tkzDefPoint(5,0){B}
  \tkzDefPoint(2.5,0){O}
  \tkzDefPointBy[rotation=center O angle 60](B)
  \tkzGetPoint{D}
  \tkzDefPointBy[symmetry=center D](O)
  \tkzGetPoint{E}
  \begin{scope}
    \tkzDrawArc[angles](O,B)(0,180)
    \tkzDrawArc[angles,](B,O)(100,180)
    \tkzCompass[delta=20](D,E)
    \tkzDrawLines(A,B O,E B,E)
    \tkzDrawPoints(A,B,O,D,E)
  \end{scope}
  \tkzLabelPoints[below right](A,B,O,D,E)
  \tkzMarkRightAngle(O,B,E)
\end{tikzpicture}
```

24.1.8. Option angles: example 2

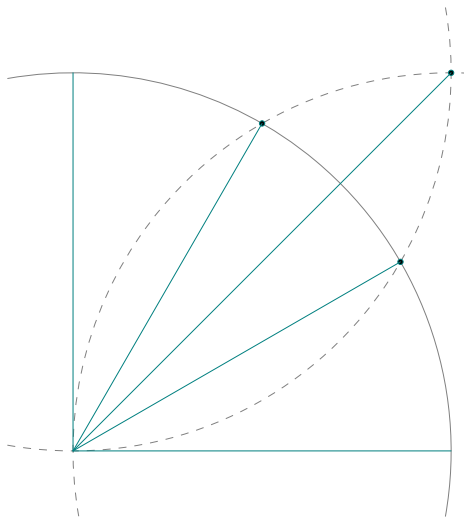

```
\begin{tikzpicture}
\tkzDefPoint(0,0){O}
\tkzDefPoint(5,0){I}
\tkzDefPoint(0,5){J}
\tkzInterCC(0,I)(I,0)\tkzGetPoints{B}{C}
\tkzInterCC(0,I)(J,0)\tkzGetPoints{D}{A}
\tkzInterCC(I,0)(J,0)\tkzGetPoints{L}{K}
\tkzDrawArc[angles](0,I)(0,90)
\tkzDrawArc[angles,color=gray,
style=dashed](I,0)(90,180)
\tkzDrawArc[angles,color=gray,
style=dashed](J,0)(-90,0)
\tkzDrawPoints(A,B,K)
\foreach \point in {I,A,B,J,K}{%
\tkzDrawSegment(O,\point)}
\end{tikzpicture}
```

24.1.9. Option reverse: inversion of the arrow

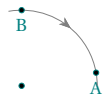

```
\begin{tikzpicture}
\tkzDefPoints{0/0/0,3/0/U}
\tkzDefPoint(10:1){A}
\tkzDefPoint(90:1){B}
\tkzLabelPoints(A,B)
\tkzDrawArc[reverse,tkz arrow={Stealth}](0,A)(B)
\tkzDrawPoints(A,B,0)
\end{tikzpicture}
```

25. Drawing a sector or sectors

25.1. \tkzDrawSector



Attention the arguments vary according to the options.

\tkzDrawSector[<i>(local options)</i>](<i>(O,...)</i>)(<i>(...)</i>)		
options	default	definition
towards	towards	O is the center and the arc from A to (OB)
rotate	towards	the arc starts from A and the angle determines its length
R	towards	We give the radius and two angles
R with nodes	towards	We give the radius and two points
<i>You have to add, of course, all the styles of TikZ for tracings...</i>		
options	arguments	example
towards	(<i>(pt,pt)</i>)(<i>(pt)</i>)	\tkzDrawSector(O,A)(B)
rotate	(<i>(pt,pt)</i>)(<i>(an)</i>)	\tkzDrawSector[rotate,color=red](O,A)(90)
R	(<i>(pt,r)</i>)(<i>(an,an)</i>)	\tkzDrawSector[R,color=teal](0,2)(30,90)
R with nodes	(<i>(pt,r)</i>)(<i>(pt,pt)</i>)	\tkzDrawSector[R with nodes](0,2)(A,B)

Here are a few examples:

25.1.1. `\tkzDrawSector` and `towards`

There's no need to put `towards`. You can use `fill` as an option.

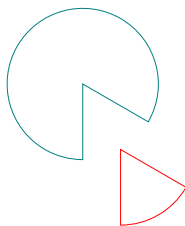

```
\begin{tikzpicture}
  \tkzDefPoint(0,0){O}
  \tkzDefPoint(-30:1){A}
  \tkzDefPointBy[rotation = center O angle -60](A)
  \tkzDrawSector[teal](O,A)(tkzPointResult)
  \begin{scope}[shift={(-60:1)}]
    \tkzDefPoint(0,0){O}
    \tkzDefPoint(-30:1){A}
    \tkzDefPointBy[rotation = center O angle -60](A)
    \tkzDrawSector[red](O,tkzPointResult)(A)
  \end{scope}
\end{tikzpicture}
```

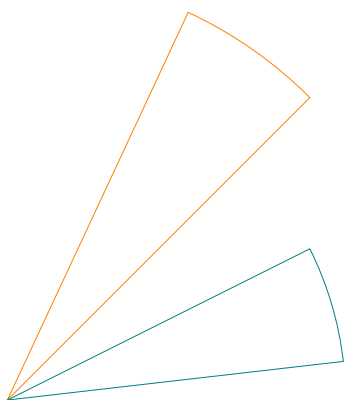
25.1.2. `\tkzDrawSector` and `rotate`

```
\begin{tikzpicture}[scale=2]
  \tkzDefPoints{0/0/O,2/2/A,2/1/B}
  \tkzDrawSector[rotate,orange](O,A)(20)
  \tkzDrawSector[rotate,teal](O,B)(-20)
\end{tikzpicture}
```

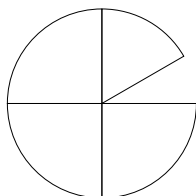
25.1.3. `\tkzDrawSector` and `R`

```
\begin{tikzpicture}[scale=1.25]
  \tkzDefPoint(0,0){O}
  \tkzDefPoint(2,-1){A}
  \tkzDrawSector[R](O,1)(30,90)
  \tkzDrawSector[R](O,1)(90,180)
  \tkzDrawSector[R](O,1)(180,270)
  \tkzDrawSector[R](O,1)(270,360)
\end{tikzpicture}
```

25.1.4. `\tkzDrawSector` and `R` with nodes

In this example I use the option `fill` but `\tkzFillSector` is possible.

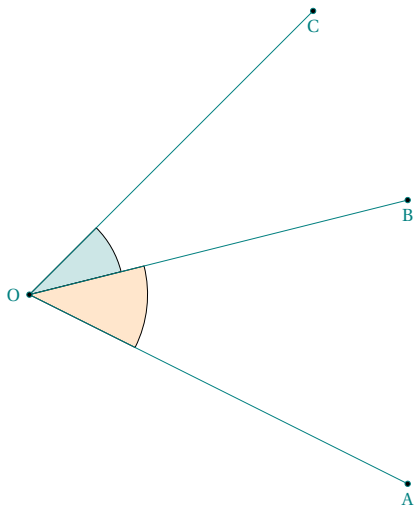

```

\begin{tikzpicture}[scale=1.25]
  \tkzDefPoint(0,0){O}
  \tkzDefPoint(4,-2){A}
  \tkzDefPoint(4,1){B}
  \tkzDefPoint(3,3){C}
  \tkzDrawSector[R with nodes,%
    fill=teal!20](O,1)(B,C)
  \tkzDrawSector[R with nodes,%
    fill=orange!20](O,1.25)(A,B)
  \tkzDrawSegments(O,A O,B O,C)
  \tkzDrawPoints(O,A,B,C)
  \tkzLabelPoints(A,B,C)
  \tkzLabelPoints[left](O)
\end{tikzpicture}

```

25.1.5. `\tkzDrawSector` and R with nodes

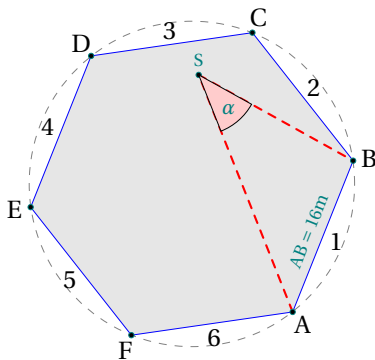

```

\begin{tikzpicture} [scale=.4]
  \tkzDefPoints{-1/-2/A,1/3/B}
  \tkzDefRegPolygon[side,sides=6](A,B)
  \tkzGetPoint{O}
  \tkzDrawPolygon[fill=black!10, draw=blue](P1,P...,P6)
  \tkzLabelRegPolygon[sep=1.05](O){A,...,F}
  \tkzDrawCircle[dashed](O,A)
  \tkzLabelSegment[above,sloped,
    midway](A,B){\(\ A B = 16m \)}
  \foreach \i [count=\xi from 1] in {2,...,6,1}
  {%
    \tkzDefMidPoint(P\xi,P\i)
    \path (O) to [pos=1.1] node {\xi} (tkzPointResult) ;
  }
  \tkzDefRandPointOn[segment = P3--P5]
  \tkzGetPoint{S}
  \tkzDrawSegments[thick,dashed,red](A,S S,B)
  \tkzDrawPoints(P1,P...,P6,S)
  \tkzLabelPoint[left,above](S){\(\ S \)}
  \tkzDrawSector[R with nodes,fill=red!20](S,2)(A,B)
  \tkzLabelAngle[pos=1.5](A,S,B){\(\ \alpha \)}
\end{tikzpicture}

```

25.2. Coloring a disc

This was possible with the macro `\tkzDrawCircle`, but disk tracing was mandatory, this is no longer the case.

```
\tkzFillColor[(local options)](A,B)
```

options	default	definition
radius	radius	two points define a radius
R	radius	a point and the measurement of a radius

You don't need to put **radius** because that's the default option. Of course, you have to add all the styles of TikZ for the plots.

25.2.1. Yin and Yang



```

\begin{tikzpicture}[scale=.75]
  \tkzDefPoint(0,0){O}
  \tkzDefPoint(-4,0){A}
  \tkzDefPoint(4,0){B}
  \tkzDefPoint(-2,0){I}
  \tkzDefPoint(2,0){J}
  \tkzDrawSector[fill=teal](O,A)(B)
  \tkzFillCircle[fill=white](J,B)
  \tkzFillCircle[fill=teal](I,A)
  \tkzDrawCircle(O,A)
\end{tikzpicture}

```

25.2.2. From a sangaku

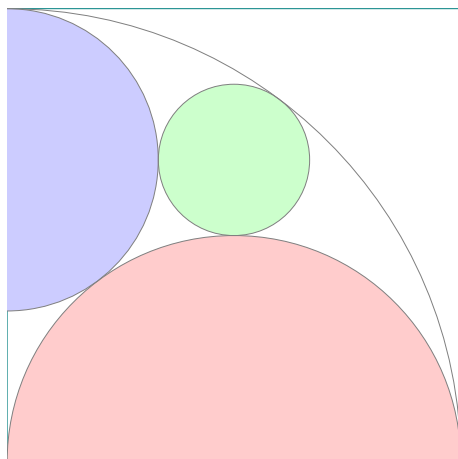

```

\begin{tikzpicture}
  \tkzDefPoint(0,0){B}  \tkzDefPoint(6,0){C}%
  \tkzDefSquare(B,C)  \tkzGetPoints{D}{A}
  \tkzClipPolygon(B,C,D,A)
  \tkzDefMidPoint(A,D)  \tkzGetPoint{F}
  \tkzDefMidPoint(B,C)  \tkzGetPoint{E}
  \tkzDefMidPoint(B,D)  \tkzGetPoint{Q}
  \tkzDefLine[tangent from = B](F,A) \tkzGetPoints{H}{G}
  \tkzInterLL(F,G)(C,D) \tkzGetPoint{J}
  \tkzInterLL(A,J)(F,E) \tkzGetPoint{K}
  \tkzDefPointBy[projection=onto B--A](K)
  \tkzGetPoint{M}
  \tkzDrawPolygon(A,B,C,D)
  \tkzFillCircle[red!20](E,B)
  \tkzFillCircle[blue!20](M,A)
  \tkzFillCircle[green!20](K,Q)
  \tkzDrawCircles(B,A M,A E,B K,Q)
\end{tikzpicture}

```

25.2.3. Clipping and filling part I



```

\begin{tikzpicture}
\tkzDefPoints{0/0/A,4/0/B,2/2/O,3/4/X,4/1/Y,1/0/Z,
              0/3/W,3/0/R,4/3/S,1/4/T,0/1/U}
\tkzDefSquare(A,B)\tkzGetPoints{C}{D}
\tkzDefPointWith[colinear normed=at X,K=1](O,X)
\tkzGetPoint{F}
\begin{scope}
\tkzFillCircle[fill=teal!20](O,F)
\tkzFillPolygon[white](A,...,D)
\tkzClipPolygon(A,...,D)
\foreach \c/\t in {S/C,R/B,U/A,T/D}
{\tkzFillCircle[teal!20](\c,\t)}
\end{scope}
\foreach \c/\t in {X/C,Y/B,Z/A,W/D}
{\tkzFillCircle[white](\c,\t)}
\foreach \c/\t in {S/C,R/B,U/A,T/D}
{\tkzFillCircle[teal!20](\c,\t)}
\end{tikzpicture}

```

25.2.4. Clipping and filling part II

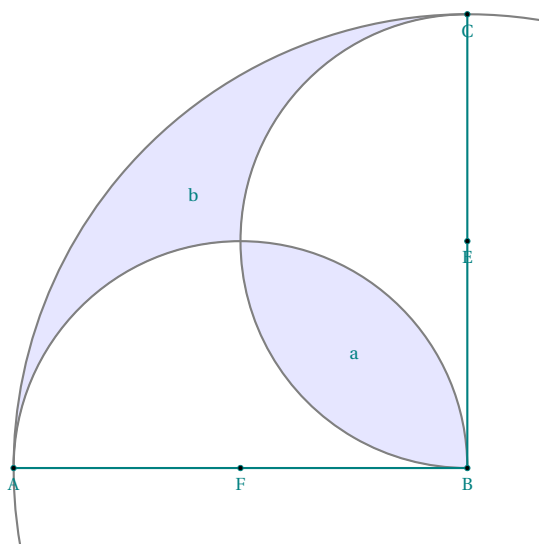

```

\begin{tikzpicture}[scale=.75]
\tkzDefPoints{0/0/A,8/0/B,8/8/C,0/8/D}
\tkzDefMidPoint(A,B)\tkzGetPoint{F}
\tkzDefMidPoint(B,C)\tkzGetPoint{E}
\tkzDefMidPoint(D,B)\tkzGetPoint{I}
\tkzDefMidPoint(I,B)\tkzGetPoint{a}
\tkzInterLC(B,I)(B,C)\tkzGetSecondPoint{K}
\tkzDefMidPoint(I,K)\tkzGetPoint{b}
\begin{scope}
\tkzFillSector[fill=blue!10](B,C)(A)
\tkzDefMidPoint(A,B)\tkzGetPoint{x}
\tkzDrawSemiCircle[fill=white](x,B)
\tkzDefMidPoint(B,C)\tkzGetPoint{y}
\tkzDrawSemiCircle[fill=white](y,C)
\tkzClipCircle(E,B)
\tkzClipCircle(F,B)
\tkzFillCircle[fill=blue!10](B,A)
\end{scope}
\tkzDrawSemiCircle[thick](F,B)
\tkzDrawSemiCircle[thick](E,C)
\tkzDrawArc[thick](B,C)(A)
\tkzDrawSegments[thick](A,B B,C)
\tkzDrawPoints(A,B,C,E,F)
\tkzLabelPoints[centered](a,b)
\tkzLabelPoints(A,B,C,E,F)
\end{tikzpicture}

```

25.2.5. Clipping and filling part III

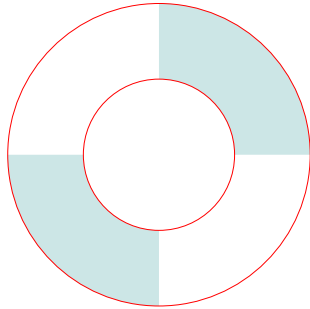

```
\begin{tikzpicture}
  \tkzDefPoint(0,0){A} \tkzDefPoint(1,0){B}
  \tkzDefPoint(2,0){C} \tkzDefPoint(-3,0){a}
  \tkzDefPoint(3,0){b} \tkzDefPoint(0,3){c}
  \tkzDefPoint(0,-3){d}
  \begin{scope}
    \tkzClipPolygon(a,b,c,d)
    \tkzFillCircle[teal!20](A,C)
  \end{scope}
  \tkzFillCircle[white](A,B)
  \tkzDrawCircle[color=red](A,C)
  \tkzDrawCircle[color=red](A,B)
\end{tikzpicture}
```

25.3. Coloring a polygon

```
\tkzFillPolygon[<local options>](<points list>)
```

You can color by drawing the polygon, but in this case you color the inside of the polygon without drawing it.

arguments	example	explanation
(<pt1,pt2,...>)	(<A,B,...>)	

25.3.1. \tkzFillPolygon

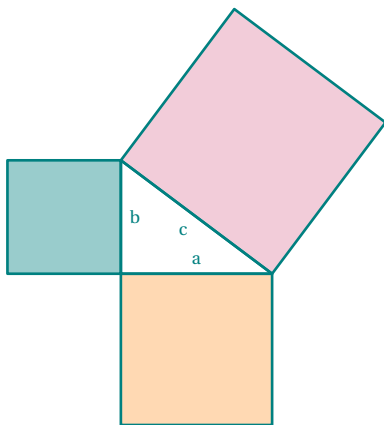

```
\begin{tikzpicture}[scale=.5]
  \tkzDefPoint(0,0){C} \tkzDefPoint(4,0){A}
  \tkzDefPoint(0,3){B}
  \tkzDefSquare(B,A) \tkzGetPoints{E}{F}
  \tkzDefSquare(A,C) \tkzGetPoints{G}{H}
  \tkzDefSquare(C,B) \tkzGetPoints{I}{J}
  \tkzFillPolygon[color = orange!30 ](A,C,G,H)
  \tkzFillPolygon[color = teal!40 ](C,B,I,J)
  \tkzFillPolygon[color = purple!20](B,A,E,F)
  \tkzDrawPolygon[line width = 1pt](A,B,C)
  \tkzDrawPolygon[line width = 1pt](A,C,G,H)
  \tkzDrawPolygon[line width = 1pt](C,B,I,J)
  \tkzDrawPolygon[line width = 1pt](B,A,E,F)
  \tkzLabelSegment[above](C,A){$a$}
  \tkzLabelSegment[right](B,C){$b$}
  \tkzLabelSegment[below left](B,A){$c$}
\end{tikzpicture}
```

25.4. \tkzFillSector



Attention the arguments vary according to the options.

<code>\tkzFillSector</code> [(local options)](O,...)(A,...)		
options	default	definition
towards	towards	O is the center and the arc from A to (OB)
rotate	towards	the arc starts from A and the angle determines its length
R	towards	We give the radius and two angles
R with nodes	towards	We give the radius and two points

Of course, you have to add all the styles of TikZ for the tracings...

options	arguments	example
towards	((pt,pt))((pt))	<code>\tkzFillSector(O,A)(B)</code>
rotate	((pt,pt))((an))	<code>\tkzFillSector[rotate,color=red](O,A)(90)</code>
R	((pt,r))((an,an))	<code>\tkzFillSector[R,color=blue](O,2)(30,90)</code>
R with nodes	((pt,r))((pt,pt))	<code>\tkzFillSector[R with nodes](O,2)(A,B)</code>

25.4.1. `\tkzFillSector` and towards

It is useless to put `towards` and you will notice that the contours are not drawn, only the surface is colored.



```
\begin{tikzpicture}[scale=.6]
\tkzDefPoint(0,0){O}
\tkzDefPoint(-30:3){A}
\tkzDefPointBy[rotation = center O angle -60](A)
\tkzFillSector[fill=purple!20](O,A)(tkzPointResult)
\begin{scope}[shift={(-60:1)}]
\tkzDefPoint(0,0){O}
\tkzDefPoint(-30:3){A}
\tkzDefPointBy[rotation = center O angle -60](A)
\tkzGetPoint{A'}
\tkzFillSector[color=teal!40](O,A')(A)
\end{scope}
\end{tikzpicture}
```

25.4.2. `\tkzFillSector` and rotate

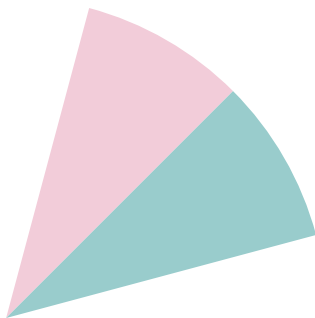

```
\begin{tikzpicture}[scale=1.5]
\tkzDefPoint(0,0){O} \tkzDefPoint(2,2){A}
\tkzFillSector[rotate,color=purple!20](O,A)(30)
\tkzFillSector[rotate,color=teal!40](O,A)(-30)
\end{tikzpicture}
```

25.5. Colour an angle: `\tkzFillAngle`

The simplest operation

```
\tkzFillAngle[⟨local options⟩](⟨A,O,B⟩)
```

O is the vertex of the angle. OA and OB are the sides. Attention the angle is determined by the order of the points.

options	default	definition
size	1	this option determines the radius of the coloured angular sector.

Of course, you have to add all the styles of TikZ, like the use of fill and shade...

25.5.1. Example with size

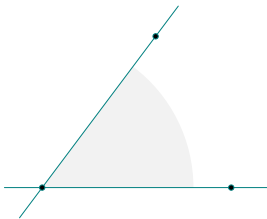

```
\begin{tikzpicture}
\tkzInit
\tkzDefPoints{0/0/0,2.5/0/A,1.5/2/B}
\tkzFillAngle[size=2, fill=gray!10](A,O,B)
\tkzDrawLines(O,A O,B)
\tkzDrawPoints(O,A,B)
\end{tikzpicture}
```

25.5.2. Changing the order of items

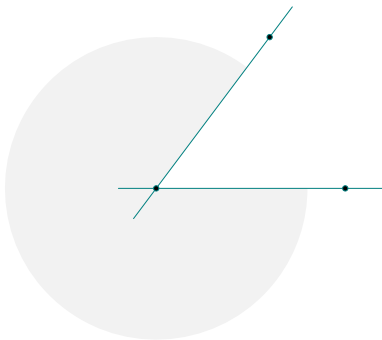

```
\begin{tikzpicture}
\tkzInit
\tkzDefPoints{0/0/0,2.5/0/A,1.5/2/B}
\tkzFillAngle[size=2,fill=gray!10](B,O,A)
\tkzDrawLines(O,A O,B)
\tkzDrawPoints(O,A,B)
\end{tikzpicture}
```

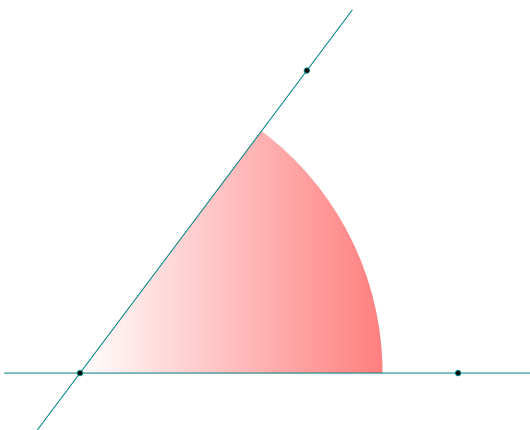

```
\begin{tikzpicture}
\tkzInit
\tkzDefPoints{0/0/0,5/0/A,3/4/B}
% Don't forget {} to get, () to use
\tkzFillAngle[size=4,left color=white,
right color=red!50](A,O,B)
\tkzDrawLines(O,A O,B)
\tkzDrawPoints(O,A,B)
\end{tikzpicture}
```

```
\tkzFillAngles[⟨local options⟩](⟨A,O,B⟩)(⟨A',O',B'⟩)etc.
```

With common options, there is a macro for multiple angles.

25.5.3. Multiples angles

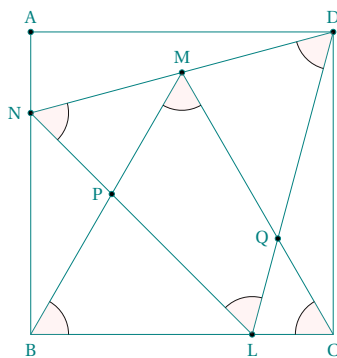

```

\begin{tikzpicture}[scale=0.5]
  \tkzDefPoints{0/0/B,8/0/C,0/8/A,8/8/D}
  \tkzDrawPolygon(B,C,D,A)
  \tkzDefTriangle[equilateral](B,C) \tkzGetPoint{M}
  \tkzInterLL(D,M)(A,B) \tkzGetPoint{N}
  \tkzDefPointBy[rotation=center N angle -60](D)
  \tkzGetPoint{L}
  \tkzInterLL(N,L)(M,B) \tkzGetPoint{P}
  \tkzInterLL(M,C)(D,L) \tkzGetPoint{Q}
  \tkzDrawSegments(D,N N,L L,D B,M M,C)
  \tkzDrawPoints(L,N,P,Q,M,A,D)
  \tkzLabelPoints[left](N,P,Q)
  \tkzLabelPoints[above](M,A,D)
  \tkzLabelPoints(L,B,C)
  \tkzMarkAngles(C,B,M B,M,C M,C,B D,L,N L,N,D N,D,L)
  \tkzFillAngles[fill=red!20,opacity=.2](C,B,M%
    B,M,C M,C,B D,L,N L,N,D N,D,L)
\end{tikzpicture}

```

26. Controlling Bounding Box

From the **PgfManual**: "When you add the clip option, the current path is used for clipping subsequent drawings. Clipping never enlarges the clipping area. Thus, when you clip against a certain path and then clip again against another path, you clip against the intersection of both. The only way to enlarge the clipping path is to end the pgfscope in which the clipping was done. At the end of a pgfscope the clipping path that was in force at the beginning of the scope is reinstalled."

First of all, you don't have to deal with TikZ the size of the bounding box. Early versions of `tkz-euclide` did not control the size of the bounding box, now with `tkz-euclide 4` the size of the bounding box is limited.

The initial bounding box after using the macro `\tkzInit` is defined by the rectangle based on the points (0,0) and (10,10). The `\tkzInit` macro allows this initial bounding box to be modified using the arguments (`xmin`, `xmax`, `ymin`, and `ymax`). Of course any external trace modifies the bounding box. TikZ maintains that bounding box. It is possible to influence this behavior either directly with commands or options in TikZ such as a command like `\useasboundingbox` or the option `use as bounding box`. A possible consequence is to reserve a box for a figure but the figure may overflow the box and spread over the main text. The following command `\pgfresetboundingbox` clears a bounding box and establishes a new one.

26.1. Utility of `\tkzInit`

However, it is sometimes necessary to control the size of what will be displayed. To do this, you need to have prepared the bounding box you are going to work in, this is the role of the macro `\tkzInit`. For some drawings, it is interesting to fix the extreme values (`xmin`, `xmax`, `ymin` and `ymax`) and to "clip" the definition rectangle in order to control the size of the figure as well as possible.

The two macros that are useful for controlling the bounding box:

- `\tkzInit`
- `\tkzClip`

To this, I added macros directly linked to the bounding box. You can now view it, backup it, restore it (see the section Bounding Box).

26.2. `\tkzInit``\tkzInit[⟨local options⟩]`

options	default	definition
<code>xmin</code>	0	minimum value of the abscissae in cm
<code>xmax</code>	10	maximum value of the abscissae in cm
<code>xstep</code>	1	difference between two graduations in x
<code>ymin</code>	0	minimum y-axis value in cm
<code>ymax</code>	10	maximum y-axis value in cm
<code>ystep</code>	1	difference between two graduations in y

The role of `\tkzInit` is to define a **orthogonal** coordinates system and a rectangular part of the plane in which you will place your drawings using Cartesian coordinates. This macro allows you to define your working environment as with a calculator. With `tkz-euclide 4` `\xstep` and `\ystep` are always 1. Logically it is no longer useful to use `\tkzInit`, except for an action like "Clipping Out".

26.3. `\tkzClip``\tkzClip[⟨local options⟩]`

The role of this macro is to make invisible what is outside the rectangle defined by `(xmin ; ymin)` and `(xmax ; ymax)`.

options	default	definition
<code>space</code>	1	added value on the right, left, bottom and top of the background

The role of the `space` option is to enlarge the visible part of the drawing. This part becomes the rectangle defined by `(xmin-space ; ymin-space)` and `(xmax+space ; ymax+space)`. `space` can be negative! The unit is cm and should not be specified.

The role of this macro is to "clip" the initial rectangle so that only the paths contained in this rectangle are drawn.

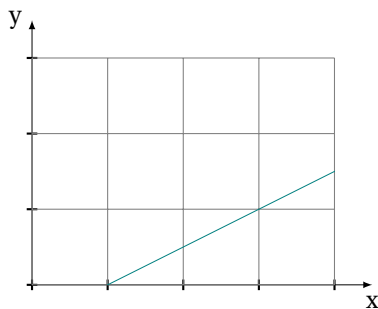

```
\begin{tikzpicture}
\tkzInit[xmax=4, ymax=3]
\tkzDefPoints{-1/-1/A,5/2/B}
\tkzDrawX \tkzDrawY
\tkzGrid
\tkzClip
\tkzDrawSegment(A,B)
\end{tikzpicture}
```

It is possible to add a bit of space

```
\tkzClip[space=1]
```

26.4. `\tkzClip` and the option `space`

This option allows you to add some space around the "clipped" rectangle.

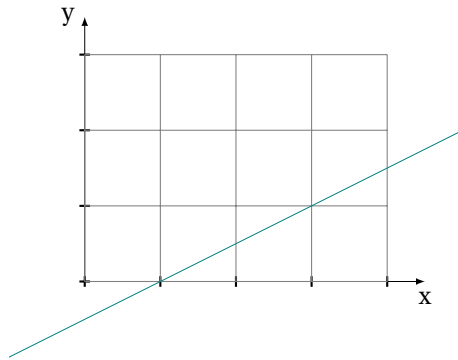

```
\begin{tikzpicture}
\tkzInit[xmax=4, ymax=3]
\tkzDefPoints{-1/-1/A,5/2/B}
\tkzDrawX \tkzDrawY
\tkzGrid
\tkzClip[space=1]
\tkzDrawSegment(A,B)
\end{tikzpicture}
```

The dimensions of the "clipped" rectangle are $x_{min}-1$, $y_{min}-1$, $x_{max}+1$ and $y_{max}+1$.

26.5. tkzShowBB

The simplest macro.

```
\tkzShowBB[⟨local options⟩]
```

This macro displays the bounding box. A rectangular frame surrounds the bounding box. This macro accepts TikZ options.

26.5.1. Example with \tkzShowBB

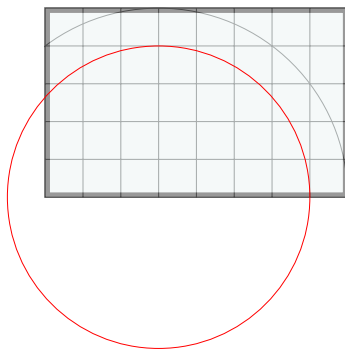

```
\begin{tikzpicture}[scale=.5]
\tkzInit[ymax=5,xmax=8]
\tkzGrid
\tkzDefPoint(3,0){A}
\begin{scope}
\tkzClipBB
\tkzDefCircle[R](A,5) \tkzGetPoint{a}
\tkzDrawCircle(A,a)
\tkzShowBB[line width = 4pt,fill=teal!10,opacity=.4]
\end{scope}
\tkzDefCircle[R](A,4) \tkzGetPoint{b}
\tkzDrawCircle[red](A,b)
\end{tikzpicture}
```

26.6. tkzClipBB

```
\tkzClipBB
```

The idea is to limit future constructions to the current bounding box.

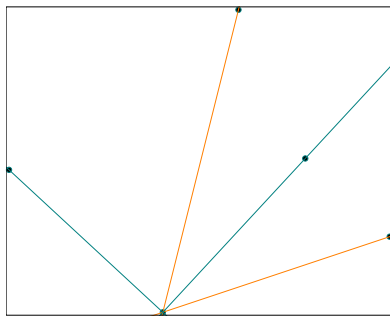
26.6.1. Example with `\tkzClipBB` and the bisectors

```

\begin{tikzpicture}
\tkzInit[xmin=-3,xmax=6, ymin=-1,ymax=6]
\tkzDefPoint(0,0){O}\tkzDefPoint(3,1){I}
\tkzDefPoint(1,4){J}
\tkzDefLine[bisector](I,O,J) \tkzGetPoint{i}
\tkzDefLine[bisector out](I,O,J) \tkzGetPoint{j}
\tkzDrawPoints(O,I,J,i,j)
\tkzClipBB
\tkzDrawLines[add = 1 and 2,color=orange](O,I O,J)
\tkzDrawLines[add = 1 and 2](O,i O,j)
\tkzShowBB
\end{tikzpicture}

```

27. Clipping different objects

27.1. Clipping a polygon

<code>\tkzClipPolygon[⟨local options⟩](⟨points list⟩)</code>
--

This macro makes it possible to contain the different plots in the designated polygon.

arguments	example	explanation
<code>(⟨pt1,pt2,pt3,...⟩)</code>	<code>(⟨A,B,C⟩)</code>	
options	default	definition
<code>out</code>		allows to clip the outside of the object

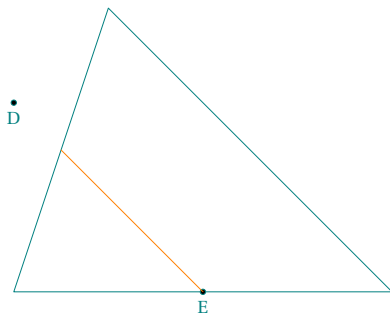
27.1.1. `\tkzClipPolygon`

```
\begin{tikzpicture}[scale=1.25]
\tkzDefPoint(0,0){A}
\tkzDefPoint(4,0){B}
\tkzDefPoint(1,3){C}
\tkzDrawPolygon(A,B,C)
\tkzDefPoint(0,2){D}
\tkzDefPoint(2,0){E}
\tkzDrawPoints(D,E)
\tkzLabelPoints(D,E)
\tkzClipPolygon(A,B,C)
\tkzDrawLine[new](D,E)
\end{tikzpicture}
```

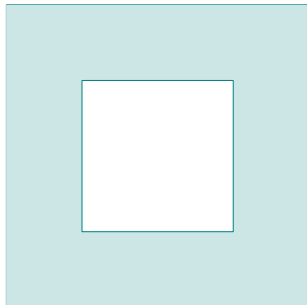
27.1.2. `\tkzClipPolygon[out]`

```
\begin{tikzpicture}[scale=1]
\tkzDefPoint(0,0){P1}
\tkzDefPoint(4,0){P2}
\tkzDefPoint(4,4){P3}
\tkzDefPoint(0,4){P4}
\tkzDefPoint(1,1){Q1}
\tkzDefPoint(3,1){Q2}
\tkzDefPoint(3,3){Q3}
\tkzDefPoint(1,3){Q4}
\tkzDrawPolygon(P1,P2,P3,P4)
\begin{scope}
\tkzClipPolygon[out](Q1,Q2,Q3,Q4)
\tkzFillPolygon[teal!20](P1,P2,P3,P4)
\end{scope}
\tkzDrawPolygon(Q1,Q2,Q3,Q4)
\end{tikzpicture}
```

27.1.3. Example: use of "Clip" for Sangaku in a square

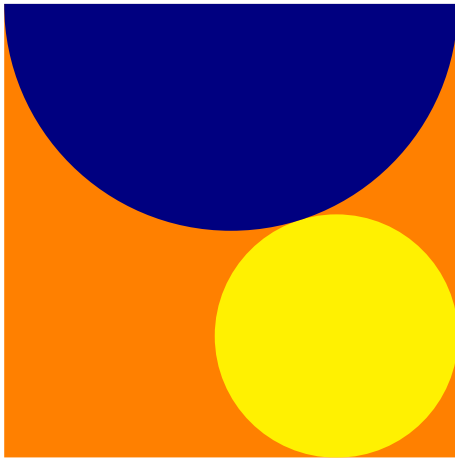

```
\begin{tikzpicture}[scale=.75]
\tkzDefPoint(0,0){A} \tkzDefPoint(8,0){B}
\tkzDefSquare(A,B) \tkzGetPoints{C}{D}
\tkzDefPoint(4,8){F}
\tkzDefTriangle[equilateral](C,D)
\tkzGetPoint{I}
\tkzDefPointBy[projection=onto B--C](I)
\tkzGetPoint{J}
\tkzInterLL(D,B)(I,J) \tkzGetPoint{K}
\tkzDefPointBy[symmetry=center K](B)
\tkzGetPoint{M}
\tkzClipPolygon(B,C,D,A)
\tkzFillPolygon[color = orange](A,B,C,D)
\tkzFillCircle[color = yellow](M,I)
\tkzFillCircle[color = blue!50!black](F,D)
\end{tikzpicture}
```

27.2. Clipping a disc

```
\tkzClipCircle[(local options)]((A,B))
```

arguments	example	explanation
(A,B)	(A,B)	AB radius
options	default	definition
out		allows to clip the outside of the object

It is not necessary to put **radius** because that is the default option.

27.2.1. Simple clip

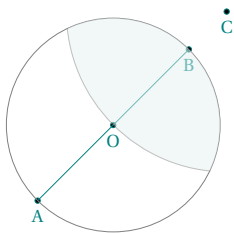

```
\begin{tikzpicture}[scale=.5]
\tkzDefPoint(0,0){A} \tkzDefPoint(2,2){O}
\tkzDefPoint(4,4){B} \tkzDefPoint(5,5){C}
\tkzDrawPoints(O,A,B,C)
\tkzLabelPoints(O,A,B,C)
\tkzDrawCircle(O,A)
\tkzClipCircle(O,A)
\tkzDrawLine(A,C)
\tkzDrawCircle[fill=teal!10,opacity=.5](C,O)
\end{tikzpicture}
```

27.3. Clip out

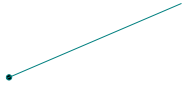

```

\begin{tikzpicture}
  \tkzInit[xmin=-3,ymin=-2,xmax=4,ymax=3]
  \tkzDefPoint(0,0){O}
  \tkzDefPoint(-4,-2){A}
  \tkzDefPoint(3,1){B}
  \tkzDefCircle[R](O,2) \tkzGetPoint{o}
  \tkzDrawPoints(A,B) % to have a good bounding box
  \begin{scope}
    \tkzClipCircle[out](O,o)
    \tkzDrawLines(A,B)
  \end{scope}
\end{tikzpicture}

```

27.4. Intersection of disks

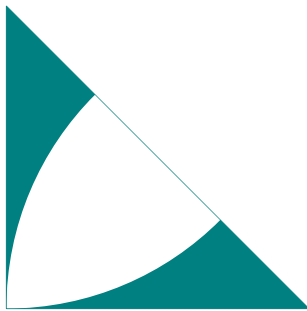

```

\begin{tikzpicture}
  \tkzDefPoints{0/0/0,4/0/A,0/4/B}
  \tkzDrawPolygon[fill=teal](O,A,B)
  \tkzClipPolygon(O,A,B)
  \tkzClipCircle(A,O)
  \tkzClipCircle(B,O)
  \tkzFillPolygon[white](O,A,B)
\end{tikzpicture}

```

see a more complex example about clipping here : [45.6](#)

27.5. Clipping a sector



Attention the arguments vary according to the options.

```
\tkzClipSector[local options](O,...)(...)
```

options	default	definition
towards	towards	O is the center and the sector starts from A to (OB)
rotate	towards	The sector starts from A and the angle determines its amplitude.
R	towards	We give the radius and two angles

You have to add, of course, all the styles of TikZ for tracings...

options	arguments	example
towards	(<i>pt</i> , <i>pt</i>)(<i>pt</i>)	\tkzClipSector(O,A)(B)
rotate	(<i>pt</i> , <i>pt</i>)(<i>angle</i>)	\tkzClipSector[rotate](O,A)(90)
R	(<i>pt</i> , <i>r</i>)(<i>angle 1</i> , <i>angle 2</i>)	\tkzClipSector[R](O,2)(30,90)

27.5.1. Example 1

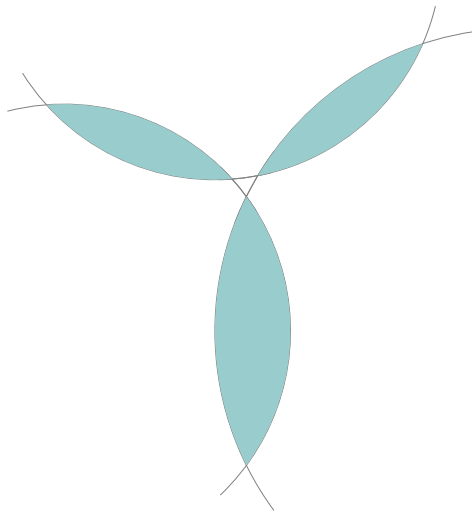

```

\begin{tikzpicture}[scale=0.5]
\tkzDefPoint(0,0){a}
\tkzDefPoint(12,0){b}
\tkzDefPoint(4,10){c}
\tkzInterCC[R](a,6)(b,8)
\tkzGetFirstPoint{AB1} \tkzGetSecondPoint{AB2}
\tkzInterCC[R](a,6)(c,6)
\tkzGetFirstPoint{AC1} \tkzGetSecondPoint{AC2}
\tkzInterCC[R](b,8)(c,6)
\tkzGetFirstPoint{BC1} \tkzGetSecondPoint{BC2}
\tkzDrawArc(a,AB2)(AB1)
\tkzDrawArc(b,AB1)(AB2)
\tkzDrawArc(a,AC2)(AC1)
\tkzDrawArc(c,AC1)(AC2)
\tkzDrawArc(b,BC2)(BC1)
\tkzDrawArc(c,BC1)(BC2)
\begin{scope}
\tkzClipSector(b,BC2)(BC1)
\tkzFillSector[teal!40!white](c,BC1)(BC2)
\end{scope}
\begin{scope}
\tkzClipSector(a,AB2)(AB1)
\tkzFillSector[teal!40!white](b,AB1)(AB2)
\end{scope}
\begin{scope}
\tkzClipSector(a,AC2)(AC1)
\tkzFillSector[teal!40!white](c,AC1)(AC2)
\end{scope}
\end{tikzpicture}

```

27.5.2. Example 2

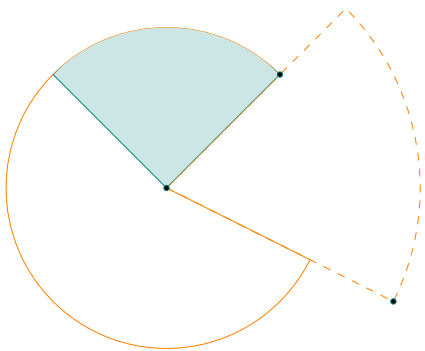

```

\begin{tikzpicture}[scale=1.5]
\tkzDefPoint(0,0){O}
\tkzDefPoint(2,-1){A}
\tkzDefPoint(1,1){B}
\tkzDrawSector[new,dashed](O,A)(B)
\tkzDrawSector[new](O,B)(A)
\begin{scope}
\tkzClipSector(O,B)(A)
\tkzDefSquare(O,B) \tkzGetPoints{B'}{O'}
\tkzDrawPolygon[color=teal,fill=teal!20](O,B,B',O')
\end{scope}
\tkzDrawPoints(A,B,O)
\end{tikzpicture}

```

27.6. Options from TikZ: trim left or right

See the **pgfmanual**

27.7. TikZ Controls `\pgfinterruptboundingbox` and `\endpgfinterruptboundingbox`

This command temporarily interrupts the calculation of the box and configures a new box. See the **pgfmanual**

27.7.1. Example about controlling the bounding box

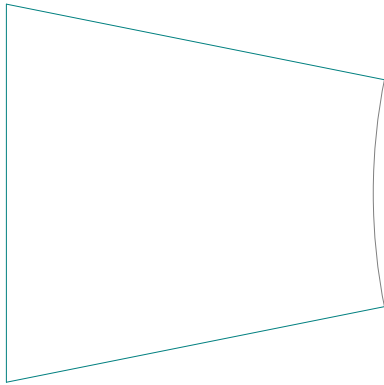

```

\begin{tikzpicture}
\tkzDefPoint(0,5){A}\tkzDefPoint(5,4){B}
\tkzDefPoint(0,0){C}\tkzDefPoint(5,1){D}
\tkzDrawSegments(A,B C,D A,C)
\pgfinterruptboundingbox
\tkzInterLL(A,B)(C,D)\tkzGetPoint{I}
\endpgfinterruptboundingbox
\tkzClipBB
\tkzDrawCircle(I,B)
\end{tikzpicture}

```

27.8. Reverse clip: tkzreverseclip

In order to use this option, a bounding box must be defined.

```

\tikzset{tkzreverseclip/.style={insert path={
(current bounding box.south west) --(current bounding box.north west)
--(current bounding box.north east) -- (current bounding box.south east)
-- cycle} }}

```

27.8.1. Example with \tkzClipPolygon[out]

`\tkzClipPolygon[out]`, `\tkzClipCircle[out]` use this option.

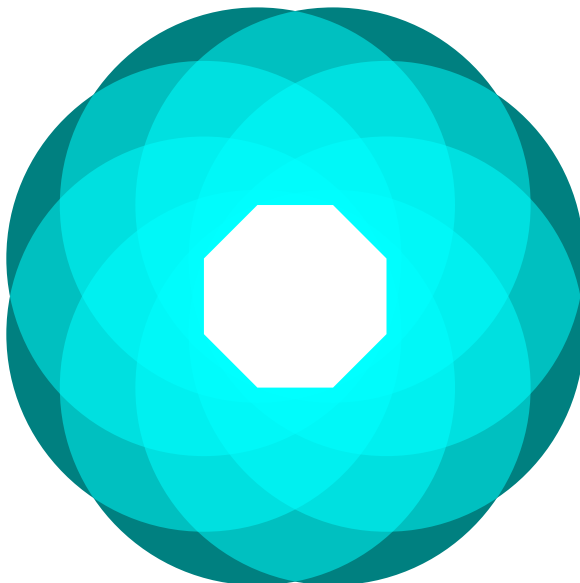

```
\begin{tikzpicture}[scale=1]
\tkzInit[xmin=-5,xmax=5,ymin=-4,ymax=6]
\tkzClip
\tkzDefPoints{-.5/0/P1,.5/0/P2}
\foreach \i [count=\j from 3] in {2,...,7}{%
  \tkzDefShiftPoint[P\i]({45*(\i-1)}:1){P\j}}
\tkzClipPolygon[out](P1,P...,P8)
\tkzCalcLength(P1,P5)\tkzGetLength{r}
\begin{scope}[blend group=screen]
  \foreach \i in {1,...,8}{%
    \tkzDefCircle[R](P\i,\r) \tkzGetPoint{x}
    \tkzFillCircle[color=teal](P\i,x)}
  \end{scope}
\end{tikzpicture}
```

Part V.

Marking

27.9. Mark a segment `\tkzMarkSegment`

```
\tkzMarkSegment[⟨local options⟩](⟨pt1,pt2⟩)
```

The macro allows you to place a mark on a segment.

options	default	definition
pos	.5	position of the mark
color	black	color of the mark
mark	none	choice of the mark
size	4pt	size of the mark

Possible marks are those provided by TikZ, but other marks have been created based on an idea by Yves Combe.

27.9.1. Several marks

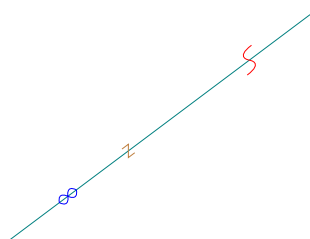

```
\begin{tikzpicture}
\tkzDefPoint(2,1){A}
\tkzDefPoint(6,4){B}
\tkzDrawSegment(A,B)
\tkzMarkSegment[color=brown,size=2pt,pos=0.4,mark=z](A,B)
\tkzMarkSegment[color=blue,pos=0.2,mark=oo](A,B)
\tkzMarkSegment[pos=0.8,mark=s,color=red](A,B)
\end{tikzpicture}
```

27.9.2. Use of mark

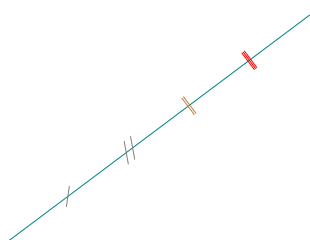

```
\begin{tikzpicture}
\tkzDefPoint(2,1){A}
\tkzDefPoint(6,4){B}
\tkzDrawSegment(A,B)
\tkzMarkSegment[color=gray,pos=0.2,mark=s|](A,B)
\tkzMarkSegment[color=gray,pos=0.4,mark=s||](A,B)
\tkzMarkSegment[color=brown,pos=0.6,mark=||](A,B)
\tkzMarkSegment[color=red,pos=0.8,mark=|||](A,B)
\end{tikzpicture}
```

27.10. Marking segments `\tkzMarkSegments`

```
\tkzMarkSegments[⟨local options⟩](⟨pt1,pt2 pt3,pt4 ...⟩)
```

Arguments are a list of pairs of points separated by spaces. The styles of TikZ are available for plots.

27.10.1. Marks for an isosceles triangle

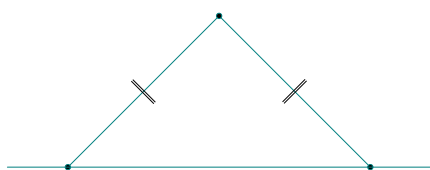

```
\begin{tikzpicture}[scale=1]
\tkzDefPoints{0/0/0,2/2/A,4/0/B,6/2/C}
\tkzDrawSegments(O,A A,B)
\tkzDrawPoints(O,A,B)
\tkzDrawLine(O,B)
\tkzMarkSegments[mark=||,size=6pt](O,A A,B)
\end{tikzpicture}
```

27.11. Another marking

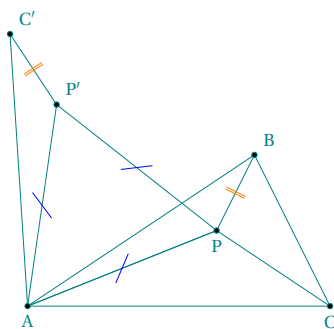

```

\begin{tikzpicture}[scale=1]
  \tkzDefPoint(0,0){A}\tkzDefPoint(3,2){B}
  \tkzDefPoint(4,0){C}\tkzDefPoint(2.5,1){P}
  \tkzDrawPolygon(A,B,C)
  \tkzDefEquilateral(A,P) \tkzGetPoint{P'}
  \tkzDefPointsBy[rotation=center A angle 60](P,B){P',C'}
  \tkzDrawPolygon(A,P,P')
  \tkzDrawPolySeg(P',C',A,P,B)
  \tkzDrawSegment(C,P)
  \tkzDrawPoints(A,B,C,C',P,P')
  \tkzMarkSegments[mark=s|,size=6pt,
  color=blue](A,P P,P' P',A)
  \tkzMarkSegments[mark=||,color=orange](B,P P',C')
  \tkzLabelPoints(A,C) \tkzLabelPoints[below](P)
  \tkzLabelPoints[above right](P',C',B)
\end{tikzpicture}

```

27.12. Mark an arc `\tkzMarkArc`

```
\tkzMarkArc[local options](pt1,pt2,pt3)
```

The macro allows you to place a mark on an arc. *pt1* is the center, *pt2* and *pt3* are the endpoints of the arc.

options	default	definition
<code>pos</code>	<code>.5</code>	position of the mark
<code>color</code>	<code>black</code>	color of the mark
<code>mark</code>	<code>none</code>	choice of the mark
<code>size</code>	<code>4pt</code>	size of the mark

Possible marks are those provided by TikZ, but other marks have been created based on an idea by Yves Combe.

|, ||,|||, z, s, x, o, oo

27.12.1. Several marks

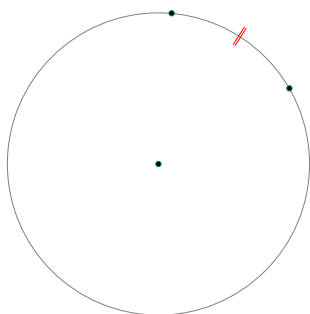

```

\begin{tikzpicture}
  \tkzDefPoint(0,0){O}
  \pgfmathsetmacro\r{2}
  \tkzDefPoint(30:\r){A}
  \tkzDefPoint(85:\r){B}
  \tkzDrawCircle(O,A)
  \tkzMarkArc[color=red,mark=||](O,A,B)
  \tkzDrawPoints(B,A,O)
\end{tikzpicture}

```

27.13. Mark an angle mark : `\tkzMarkAngle`

More delicate operation because there are many options. The symbols used for marking in addition to those of TikZ are defined in the file `tkz-lib-marks.tex` and designated by the following characters:

|, ||, |||, z, s, x, o, oo

`\tkzMarkAngle[⟨local options⟩](⟨A,O,B⟩)`

O is the vertex. Attention the arguments vary according to the options. Several markings are possible. You can simply draw an arc or add a mark on this arc. The style of the arc is chosen with the option `arc`, the radius of the arc is given by `mksize`, the arc can, of course, be colored.

options	default	definition
<code>arc</code>	1	choice of 1, ll and lll (single, double or triple).
<code>size</code>	1 (cm)	arc radius.
<code>mark</code>	none	choice of mark.
<code>mksize</code>	4pt	symbol size (mark).
<code>mkcolor</code>	black	symbol color (mark).
<code>mkpos</code>	0.5	position of the symbol on the arc.

27.13.1. Example with `mark = x` and with `mark = ||`

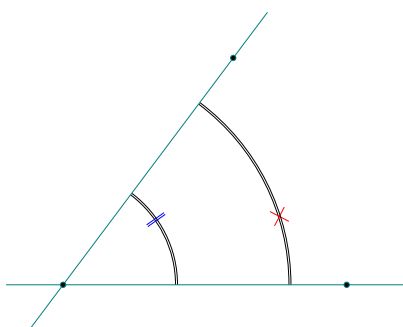

```
\begin{tikzpicture}[scale=.75]
\tkzDefPoints{O/O,5/O/A,3/4/B}
\tkzMarkAngle[size = 4,mark = x,
arc=ll,mkcolor = red,mkpos=.33](A,O,B)
\tkzMarkAngle[size = 2,mark = ||,
arc=ll,mkcolor = blue,mkpos=.66](A,O,B)
\tkzDrawLines(O,A O,B)
\tkzDrawPoints(O,A,B)
\end{tikzpicture}
```

`\tkzMarkAngles[⟨local options⟩](⟨A,O,B⟩)(⟨A',O',B'⟩)etc.`

With common options, there is a macro for multiple angles.

27.14. Marking a right angle: `\tkzMarkRightAngle`

`\tkzMarkRightAngle[⟨local options⟩](⟨A,O,B⟩)`

The `german` option allows you to change the style of the drawing. The option `size` allows to change the size of the drawing.

options	default	definition
<code>german</code>	normal	german arc with inner point.
<code>size</code>	0.2	side size.

27.14.1. Example of marking a right angle

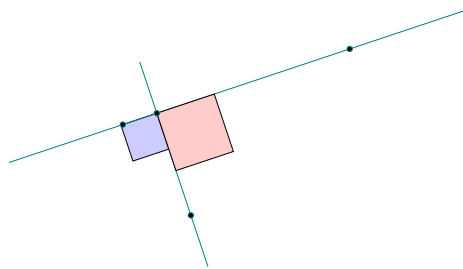

```
\begin{tikzpicture}
\tkzDefPoints{0/0/A,3/1/B,0.9/-1.2/P}
\tkzDefPointBy[projection = onto B--A](P) \tkzGetPoint{H}
\tkzDrawLines[add=.5 and .5](P,H)
\tkzMarkRightAngle[fill=blue!20,size=.5,draw](A,H,P)
\tkzDrawLines[add=.5 and .5](A,B)
\tkzMarkRightAngle[fill=red!20,size=.8](B,H,P)
\tkzDrawPoints[](A,B,P,H)
\end{tikzpicture}
```

27.14.2. Example of marking a right angle, german style

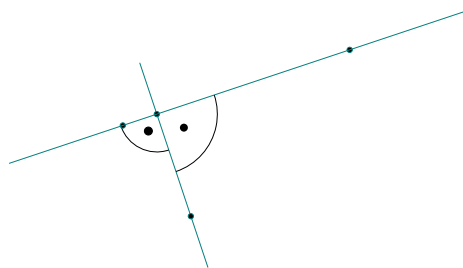

```
\begin{tikzpicture}
\tkzDefPoints{0/0/A,3/1/B,0.9/-1.2/P}
\tkzDefPointBy[projection = onto B--A](P) \tkzGetPoint{H}
\tkzDrawLines[add=.5 and .5](P,H)
\tkzMarkRightAngle[german,size=.5,draw](A,H,P)
\tkzDrawPoints[](A,B,P,H)
\tkzDrawLines[add=.5 and .5](A,B)
\tkzMarkRightAngle[german,size=.8](P,H,B)
\end{tikzpicture}
```

27.14.3. Mix of styles

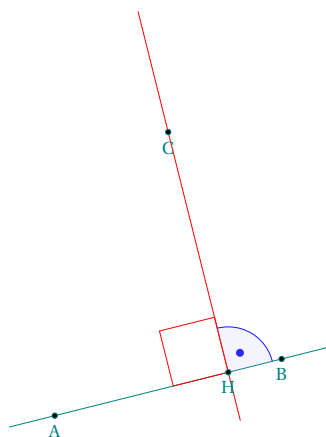

```
\begin{tikzpicture}[scale=.75]
\tkzDefPoint(0,0){A}
\tkzDefPoint(4,1){B}
\tkzDefPoint(2,5){C}
\tkzDefPointBy[projection=onto B--A](C)
\tkzGetPoint{H}
\tkzDrawLine(A,B)
\tkzDrawLine[add = .5 and .2,color=red](C,H)
\tkzMarkRightAngle[,size=1,color=red](C,H,A)
\tkzMarkRightAngle[german,size=.8,color=blue](B,H,C)
\tkzFillAngle[opacity=.2,fill=blue!20,size=.8](B,H,C)
\tkzLabelPoints(A,B,C,H)
\tkzDrawPoints(A,B,C,H)
\end{tikzpicture}
```

27.14.4. Full example

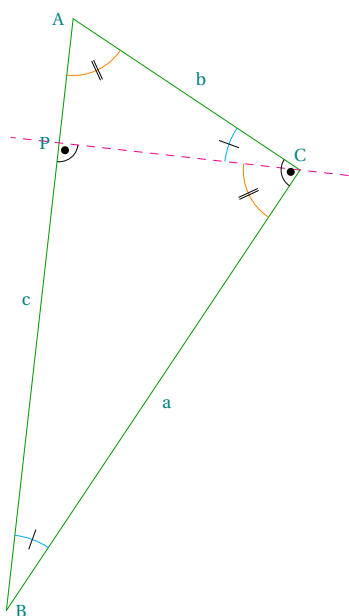

```

\begin{tikzpicture}[rotate=-90]
\tkzDefPoint(0,1){A}
\tkzDefPoint(2,4){C}
\tkzDefPointWith[orthogonal normed,K=7](C,A)
\tkzGetPoint{B}
\tkzDrawSegment[green!60!black](A,C)
\tkzDrawSegment[green!60!black](C,B)
\tkzDrawSegment[green!60!black](B,A)
\tkzDefSpcTriangle[orthic](A,B,C){N,O,P}
\tkzDrawLine[dashed,color=magenta](C,P)
\tkzLabelPoint[left](A){$A$}
\tkzLabelPoint[right](B){$B$}
\tkzLabelPoint[above](C){$C$}
\tkzLabelPoint[left](P){$P$}
\tkzLabelSegment[auto](B,A){$c$}
\tkzLabelSegment[auto,swap](B,C){$a$}
\tkzLabelSegment[auto,swap](C,A){$b$}
\tkzMarkAngle[size=1,color=cyan,mark=|](C,B,A)
\tkzMarkAngle[size=1,color=cyan,mark=|](A,C,P)
\tkzMarkAngle[size=0.75,color=orange,
mark=| |](P,C,B)
\tkzMarkAngle[size=0.75,color=orange,
mark=| |](B,A,C)
\tkzMarkRightAngle[german](A,C,B)
\tkzMarkRightAngle[german](B,P,C)
\end{tikzpicture}

```

27.15. `\tkzMarkRightAngles`

```
\tkzMarkRightAngles[⟨local options⟩](⟨A,O,B⟩)(⟨A',O',B'⟩)etc.
```

With common options, there is a macro for multiple angles.

27.16. Angles Library

If you prefer to use TikZ library `angles`, you can mark angles with the macro `\tkzPicAngle` and `\tkzPicRightAngle`.

```
\tkzPicAngle[⟨tikz options⟩](⟨A,O,B⟩)
```

options	example	definition
tikz option	see below	drawing of the angle \widehat{AOB} .

```
\tkzPicRightAngle[⟨tikz options⟩](⟨A,O,B⟩)
```

options	example	definition
tikz option	see below	drawing of the right angle \widehat{AOB} .

You need to know possible options of the `angles` library

27.16.1. Angle with TikZ

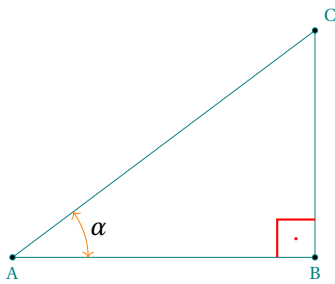

```

\begin{tikzpicture}
\tkzDefPoints{0/0/A,4/0/B}
\tkzDefTriangle[right,swap](A,B) \tkzGetPoint{C}
\tkzDrawPolygon(A,B,C)
\tkzDrawPoints(A,B,C)
\tkzLabelPoints[below](B,A)
\tkzLabelPoints[above right](C)
\tkzPicAngle["$\alpha$",draw=orange,
             <->,angle eccentricity=1.2,
             angle radius=1cm](B,A,C)
\tkzPicRightAngle[draw,red,thick,
                  angle eccentricity=.5,
                  pic text=.](C,B,A)
\end{tikzpicture}

```

Part VI.

Labelling

28. Labelling

28.1. Label for a point

It is possible to add several labels at the same point by using this macro several times.

<code>\tkzLabelPoint[(local options)](point){label}</code>		
arguments	example	
point	<code>\tkzLabelPoint(A){\$A_1\$}</code>	
options	default	definition
TikZ options	colour, position etc.	

Optionally, we can use any style of TikZ, especially placement with above, right, dots...

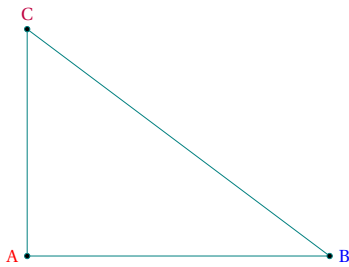
28.1.1. Example with `\tkzLabelPoint`

```
\begin{tikzpicture}
  \tkzDefPoint(0,0){A}
  \tkzDefPoint(4,0){B}
  \tkzDefPoint(0,3){C}
  \tkzDrawSegments(A,B B,C C,A)
  \tkzDrawPoints(A,B,C)
  \tkzLabelPoint[left,red](A){$A$}
  \tkzLabelPoint[right,blue](B){$B$}
  \tkzLabelPoint[above,purple](C){$C$}
\end{tikzpicture}
```

28.1.2. Label and reference

The reference of a point is the object that allows to use the point, the label is the name of the point that will be displayed.



```
\begin{tikzpicture}
  \tkzDefPoint(2,0){A}
  \tkzDrawPoint(A)
  \tkzLabelPoint[above](A){$A_1$}
\end{tikzpicture}
```

28.2. Add labels to points `\tkzLabelPoints`

It is possible to place several labels quickly when the point references are identical to the labels and when the labels are placed in the same way in relation to the points. By default, `below right` is chosen.

<code>\tkzLabelPoints[(local options)](A_1,A_2,...)</code>		
arguments	example	result
list of points	<code>\tkzLabelPoints(A,B,C)</code>	Display of A, B and C

This macro reduces the number of lines of code, but it is not obvious that all points need the same label positioning.

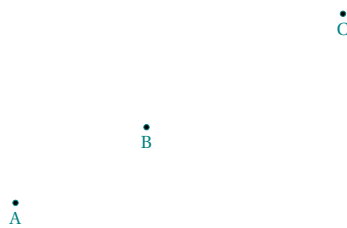
28.2.1. Example with `\tkzLabelPoints`

```

\begin{tikzpicture}
  \tkzDefPoint(2,3){A}
  \tkzDefShiftPoint[A](30:2){B}
  \tkzDefShiftPoint[A](30:5){C}
  \tkzDrawPoints(A,B,C)
  \tkzLabelPoints(A,B,C)
\end{tikzpicture}

```

28.3. Automatic position of labels `\tkzAutoLabelPoints`

The label of a point is placed in a direction defined by a center and a point `center`. The distance to the point is determined by a percentage of the distance between the center and the point. This percentage is given by `dist`.

<code>\tkzLabelPoints[⟨local options⟩](⟨A₁,A₂,...⟩)</code>		
arguments	example	result
list of points	<code>\tkzLabelPoint(A,B,C)</code>	Display of A, B and C

28.3.1. Label for points with `\tkzAutoLabelPoints`

Here the points are positioned relative to the center of gravity of A, B, C and O.

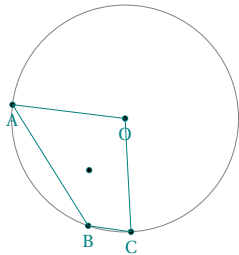

```

\begin{tikzpicture}[scale=1]
  \tkzDefPoint(2,1){O}
  \tkzDefRandPointOn[center=O radius 1.5]\tkzGetPoint{A}
  \tkzDefPointBy[rotation=center O angle 100](A)\tkzGetPoint{C}
  \tkzDefPointBy[rotation=center O angle 78](A)\tkzGetPoint{B}
  \tkzDrawCircle(O,A)
  \tkzDrawPoints(O,A,B,C)
  \tkzDrawSegments(C,B B,A A,O O,C)
  \tkzDefCentroid(A,B,C,O)
  \tkzDrawPoint(tkzPointResult)
  \tkzLabelPoints(O,A,C,B)
\end{tikzpicture}

```

29. Label for a segment

<code>\tkzLabelSegment[⟨local options⟩](⟨pt1,pt2⟩){⟨label⟩}</code>		
argument	example	definition
label	<code>\tkzLabelSegment(A,B){5}</code>	label text
(pt1,pt2)	(A,B)	label along [AB]
options	default	definition
pos	.5	label's position

29.0.1. First example



```
\begin{tikzpicture}
\tkzDefPoint(0,0){A}
\tkzDefPoint(6,0){B}
\tkzDrawSegment(A,B)
\tkzLabelSegment[above,pos=.8](A,B){$a$}
\tkzLabelSegment[below,pos=.2](A,B){$4$}
\end{tikzpicture}
```

29.0.2. Example : blackboard

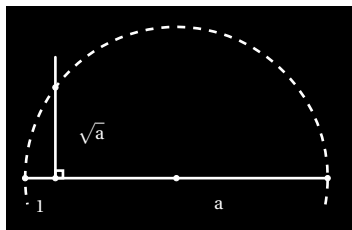

```
\tikzstyle{background rectangle}=[fill=black]
\begin{tikzpicture}[show background rectangle,scale=.4]
\tkzDefPoint(0,0){O}
\tkzDefPoint(1,0){I}
\tkzDefPoint(10,0){A}
\tkzDefPointWith[orthogonal normed,K=4](I,A)
\tkzGetPoint{H}
\tkzDefMidPoint(O,A)\tkzGetPoint{M}
\tkzInterLC(I,H)(M,A)\tkzGetPoints{B}{C}
\tkzDrawSegments[color=white,line width=1pt](I,H O,A)
\tkzDrawPoints[color=white](O,I,A,B,M)
\tkzMarkRightAngle[color=white,line width=1pt](A,I,B)
\tkzDrawArc[color=white,line width=1pt,
style=dashed](M,A)(O)
\tkzLabelSegment[white,right=1ex,pos=.5](I,B){$\sqrt{a}$}
\tkzLabelSegment[white,below=1ex,pos=.5](O,I){$1$}
\tkzLabelSegment[pos=.6,white,below=1ex](I,A){$a$}
\end{tikzpicture}
```

29.0.3. Labels and option : swap

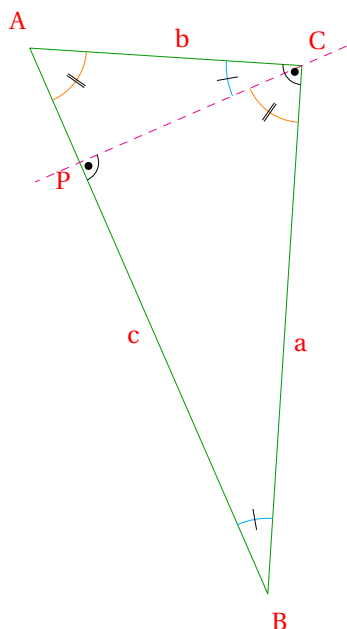

```
\begin{tikzpicture}[rotate=-60]
\tkzSetUpStyle[red,auto]{label style}
\tkzDefPoint(0,1){A}
\tkzDefPoint(2,4){C}
\tkzDefPointWith[orthogonal normed,K=7](C,A)
\tkzGetPoint{B}
\tkzDefSpcTriangle[orthic](A,B,C){N,O,P}
\tkzDefTriangleCenter[circum](A,B,C)
\tkzGetPoint{O}
\tkzDrawPolygon[green!60!black](A,B,C)
\tkzDrawLine[dashed,color=magenta](C,P)
\tkzLabelSegment(B,A){$c$}
\tkzLabelSegment[swap](B,C){$a$}
\tkzLabelSegment[swap](C,A){$b$}
\tkzMarkAngles[size=1,
color=cyan,mark=|](C,B,A A,C,P)
\tkzMarkAngle[size=0.75,
color=orange,mark=||](P,C,B)
\tkzMarkAngle[size=0.75,
color=orange,mark=||](B,A,C)
\tkzMarkRightAngles[german](A,C,B B,P,C)
\tkzAutoLabelPoints[center = 0,dist= .1](A,B,C)
\tkzLabelPoint[below left](P){$P$}
\end{tikzpicture}
```

```
\tkzLabelSegments[⟨local options⟩](⟨pt1,pt2 pt3,pt4 ...⟩)
```

The arguments are a two-point couple list. The styles of TikZ are available for plotting.

29.0.4. Labels for an isosceles triangle

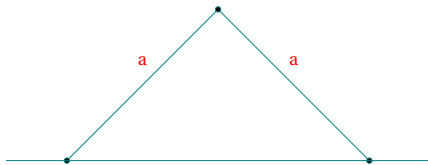

```
\begin{tikzpicture}[scale=1]
\tkzDefPoints{0/0/0,2/2/A,4/0/B,6/2/C}
\tkzDrawSegments(O,A A,B)
\tkzDrawPoints(O,A,B)
\tkzDrawLine(O,B)
\tkzLabelSegments[color=red,above=4pt](O,A A,B){$a$}
\end{tikzpicture}
```

30. Add labels on a straight line `\tkzLabelLine`

```
\tkzLabelLine[⟨local options⟩](⟨pt1,pt2⟩){⟨label⟩}
```

arguments	default	definition
label		<code>\tkzLabelLine(A,B){\$\Delta\$}</code>
options	default	definition
pos	.5	pos is an option for TikZ, but essential in this case..

As an option, and in addition to the `pos`, you can use all styles of TikZ, especially the placement with `above`, `right`, ...

30.0.1. Example with `\tkzLabelLine`

An important option is `pos`, it's the one that allows you to place the label along the right. The value of `pos` can be greater than 1 or negative.

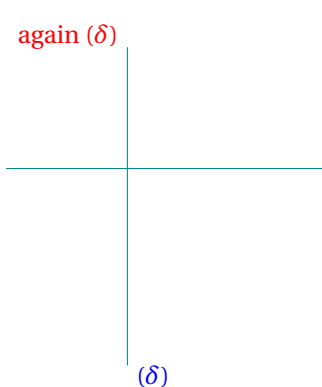

```
\begin{tikzpicture}
\tkzDefPoints{0/0/A,3/0/B,1/1/C}
\tkzDefLine[perpendicular=through C,K=-1](A,B)
\tkzGetPoint{c}
\tkzDrawLines(A,B C,c)
\tkzLabelLine[pos=1.25,blue,right](C,c){$(\delta)$}
\tkzLabelLine[pos=-0.25,red,left](C,c){again $(\delta)$}
\end{tikzpicture}
```

30.1. Label at an angle : `\tkzLabelAngle`

```
\tkzLabelAngle[⟨local options⟩](⟨A,O,B⟩)
```

There is only one option, `dist` (with or without unit), which can be replaced by the TikZ's `pos` option (without unit for the latter). By default, the value is in centimeters.

options	default	definition
<code>pos</code>	1	or <code>dist</code> , controls the distance from the top to the label.

It is possible to move the label with all TikZ options : rotate, shift, below, etc.

30.1.1. Example author js bibra stackexchange

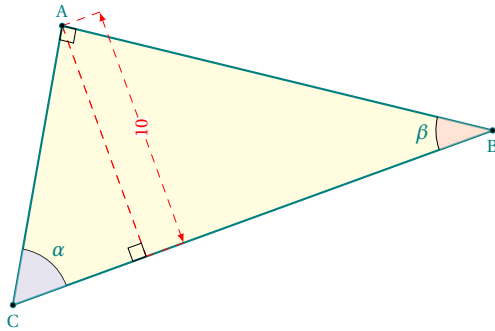

```

\begin{tikzpicture}[scale=.75]
  \tkzDefPoint(0,0){C}
  \tkzDefPoint(20:9){B}
  \tkzDefPoint(80:5){A}
  \tkzDefPointsBy[projection=onto B--C](A){a}
  \tkzDrawPolygon[thick,fill=yellow!15](A,B,C)
  \tkzDrawSegment[dashed,red](A,a)
  \tkzDrawSegment[style=red,dashed,
dim={\scriptsize},15pt,midway,font=\scriptsize,
rotate=90](A,a)
  \tkzMarkAngle(B,C,A)
  \tkzMarkRightAngle(A,a,C)
  \tkzMarkRightAngle(C,A,B)
  \tkzFillAngle[fill=blue!20,opacity=0.5](B,C,A)
  \tkzFillAngle[fill=red!20,opacity=0.5](A,B,C)
  \tkzLabelAngle[pos=1.25](A,B,C){\beta}
  \tkzLabelAngle[pos=1.25](B,C,A){\alpha}
  \tkzMarkAngle(A,B,C)
  \tkzDrawPoints(A,B,C)
  \tkzLabelPoints(B,C)
  \tkzLabelPoints[above](A)
\end{tikzpicture}

```

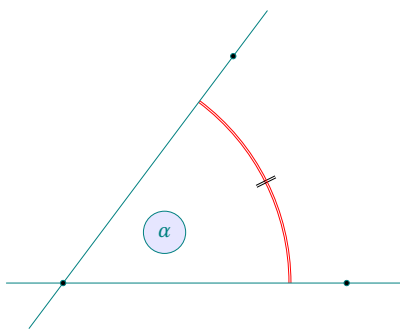
30.1.2. With `pos`

```

\begin{tikzpicture}[scale=.75]
  \tkzDefPoints{0/0/0,5/0/A,3/4/B}
  \tkzMarkAngle[size = 4,mark = ||,
arc=11,color = red](A,0,B)%
  \tkzDrawLines(0,A 0,B)
  \tkzDrawPoints(0,A,B)
  \tkzLabelAngle[pos=2,draw,circle,
fill=blue!10](A,0,B){\alpha}
\end{tikzpicture}

```

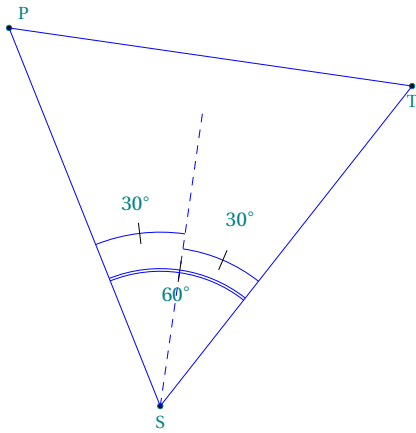
30.1.3. `pos` and `\tkzLabelAngles`

```

\begin{tikzpicture}[rotate=30]
  \tkzDefPoint(2,1){S}
  \tkzDefPoint(7,3){T}
  \tkzDefPointBy[rotation=center S angle 60](T)
  \tkzGetPoint{P}
  \tkzDefLine[bisector, normed](T,S,P)
  \tkzGetPoint{s}
  \tkzDrawPoints(S,T,P)
  \tkzDrawPolygon[color=blue](S,T,P)
  \tkzDrawLine[dashed,color=blue,add=0 and 3](S,s)
  \tkzLabelPoint[above right](P){P}
  \tkzLabelPoints(S,T)
  \tkzMarkAngle[size = 1.8,mark = |,arc=11,
    color = blue](T,S,P)
  \tkzMarkAngle[size = 2.1,mark = |,arc=1,
    color = blue](T,S,s)
  \tkzMarkAngle[size = 2.3,mark = |,arc=1,
    color = blue](s,S,P)
  \tkzLabelAngle[pos = 1.5](T,S,P){60^\circ}
  \tkzLabelAngles[pos = 2.7](T,S,s s,S,P){%
    30^\circ}
\end{tikzpicture}

```

```
\tkzLabelAngles[local options](A,O,B)(A',O',B') etc.
```

With common options, there is a macro for multiple angles.

It finally remains to be able to give a label to designate a circle and if several possibilities are offered, we will see here `\tkzLabelCircle`.

30.2. Giving a label to a circle

```
\tkzLabelCircle[tikz options](O,A)(angle){label}
```

options	default	definition
tikz options		circle O center through A

We can use the styles from TikZ. The label is created and therefore "passed" between braces.

30.2.1. Example

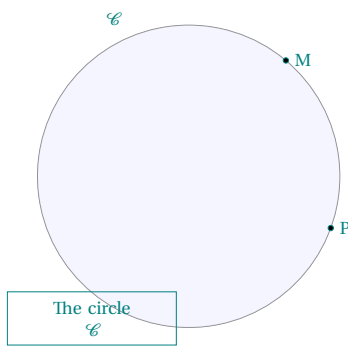

```

\begin{tikzpicture}
\tkzDefPoint(0,0){O} \tkzDefPoint(2,0){N}
\tkzDefPointBy[rotation=center O angle 50](N)
\tkzGetPoint{M}
\tkzDefPointBy[rotation=center O angle -20](N)
\tkzGetPoint{P}
\tkzDefPointBy[rotation=center O angle 125](N)
\tkzGetPoint{P'}
\tkzLabelCircle[above=4pt](O,N)(120){$\mathcal{C}$}
\tkzDrawCircle(O,M)
\tkzFillCircle[color=blue!10,opacity=.4](O,M)
\tkzLabelCircle[draw,
text width=2cm,text centered,left=24pt](O,M)(-120)%
{The circle\ \ $\mathcal{C}$}
\tkzDrawPoints(M,P)\tkzLabelPoints[right](M,P)
\end{tikzpicture}

```

31. Label for an arc

```
\tkzLabelArc[<local options>](<pt1,pt2,pt3>){<label>}
```

This macro allows you to place a label along an arc. The options are those of TikZ for example `pos`.

argument	example	definition
label	<code>\tkzLabelArc(A,B){5}</code>	label text
(pt1,pt2,pt3)	(O,A,B)	label along the arc \widehat{AB}
options	default	definition
pos	.5	label's position

31.0.1. Label on arc

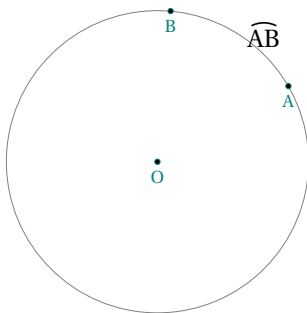

```

\begin{tikzpicture}
\tkzDefPoint(0,0){O}
\pgfmathsetmacro\r{2}
\tkzDefPoint(30:\r){A}
\tkzDefPoint(85:\r){B}
\tkzDrawCircle(O,A)
\tkzDrawPoints(B,A,O)
\tkzLabelArc[right=2pt](O,A,B){$\widearc{AB}$}
\tkzLabelPoints(A,B,O)
\end{tikzpicture}

```

Part VII.

Complements

32. Using the compass

32.1. Main macro `\tkzCompass`

$$\text{\tkzCompass}[\langle\text{local options}\rangle](\langle A,B\rangle)$$

This macro allows you to leave a compass trace, i.e. an arc at a designated point. The center must be indicated. Several specific options will modify the appearance of the arc as well as TikZ options such as style, color, line thickness etc.

You can define the length of the arc with the option `length` or the option `delta`.

options	default	definition
<code>delta</code>	0 (deg)	Increases the angle of the arc symmetrically
<code>length</code>	1 (cm)	Changes the length (in cm)

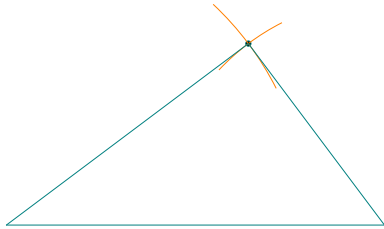
32.1.1. Option `length`

```
\begin{tikzpicture}
  \tkzDefPoint(1,1){A}
  \tkzDefPoint(6,1){B}
  \tkzInterCC[R](A,4)(B,3)
  \tkzGetPoints{C}{D}
  \tkzDrawPoint(C)
  \tkzCompass[length=1.5](A,C)
  \tkzCompass(B,C)
  \tkzDrawSegments(A,B A,C B,C)
\end{tikzpicture}
```

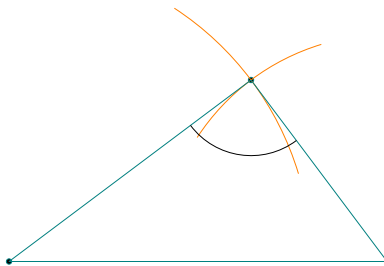
32.1.2. Option `delta`

```
\begin{tikzpicture}
  \tkzDefPoint(0,0){A}
  \tkzDefPoint(5,0){B}
  \tkzInterCC[R](A,4)(B,3)
  \tkzGetPoints{C}{D}
  \tkzDrawPoints(A,B,C)
  \tkzCompass[delta=20](A,C)
  \tkzCompass[delta=20](B,C)
  \tkzDrawPolygon(A,B,C)
  \tkzMarkAngle(A,C,B)
\end{tikzpicture}
```

32.2. Multiple constructions `\tkzCompass`

$$\text{\tkzCompass}[\langle\text{local options}\rangle](\langle\text{pt1,pt2 pt3,pt4},\dots\rangle)$$

Attention the arguments are lists of two points. This saves a few lines of code.

options	default	definition
<code>delta</code>	0	Modifies the angle of the arc by increasing it symmetrically
<code>length</code>	1	Changes the length

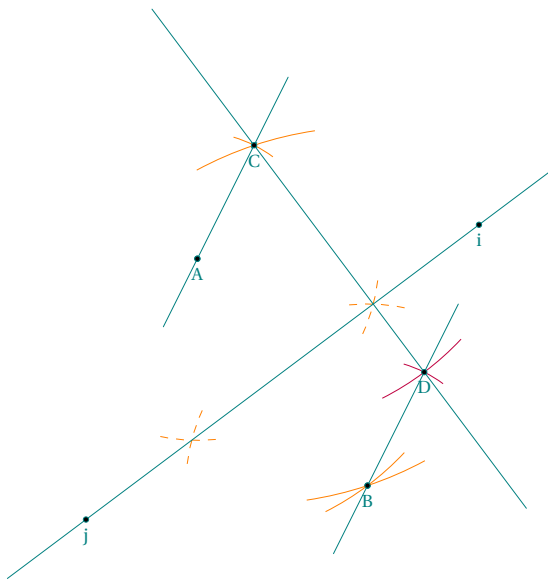
32.2.1. Use `\tkzCompass`

```

\begin{tikzpicture}[scale=.75]
\tkzDefPoint(2,2){A} \tkzDefPoint(5,-2){B}
\tkzDefPoint(3,4){C} \tkzDrawPoints(A,B)
\tkzDrawPoint[shape=cross out](C)
\tkzCompass[new](A,B A,C B,C C,B)
\tkzShowLine[mediator,new,dashed,length = 2](A,B)
\tkzShowLine[parallel = through C,
              color=purple,length=2](A,B)
\tkzDefLine[mediator](A,B)
\tkzGetPoints{i}{j}
\tkzDefLine[parallel=through C](A,B)
\tkzGetPoint{D}
\tkzDrawLines[add=.6 and .6](C,D A,C B,D)
\tkzDrawLines(i,j) \tkzDrawPoints(A,B,C,i,j,D)
\tkzLabelPoints(A,B,C,i,j,D)
\end{tikzpicture}

```

33. The Show

33.1. Show the constructions of some lines `\tkzShowLine`

```
\tkzShowLine[(local options)]((pt1,pt2)) or ((pt1,pt2,pt3))
```

These constructions concern mediatrices, perpendicular or parallel lines passing through a given point and bisectors. The arguments are therefore lists of two or three points. Several options allow the adjustment of the constructions. The idea of this macro comes from **Yves Combe**.

options	default	definition
mediator	mediator	displays the constructions of a mediator
perpendicular	mediator	constructions for a perpendicular
orthogonal	mediator	idem
bisector	mediator	constructions for a bisector
K	1	circle within a triangle
length	1	in cm, length of a arc
ratio	.5	arc length ratio
gap	2	placing the point of construction
size	1	radius of an arc (see bisector)

You have to add, of course, all the styles of TikZ for tracings...

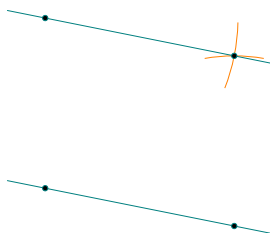
33.1.1. Example of `\tkzShowLine` and `parallel`

```

\begin{tikzpicture}
\tkzDefPoints{-1.5/-0.25/A,1/-0.75/B,-1.5/2/C}
\tkzDrawLine(A,B)
\tkzDefLine[parallel=through C](A,B) \tkzGetPoint{c}
\tkzShowLine[parallel=through C](A,B)
\tkzDrawLine(C,c) \tkzDrawPoints(A,B,C,c)
\end{tikzpicture}

```

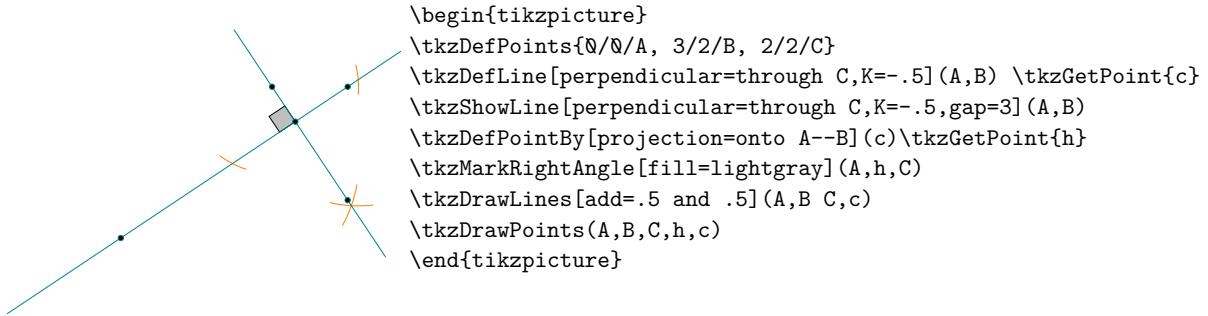
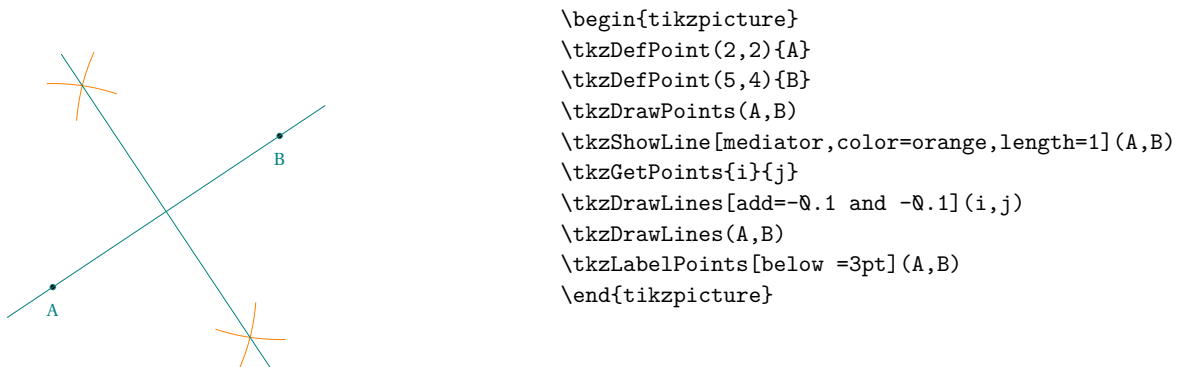
33.1.2. Example of `\tkzShowLine` and perpendicular33.1.3. Example of `\tkzShowLine` and bisector33.1.4. Example of `\tkzShowLine` and mediator33.2. Constructions of certain transformations `\tkzShowTransformation`

<code>\tkzShowTransformation</code> [(local options)]($\langle pt1,pt2 \rangle$) or ($\langle pt1,pt2,pt3 \rangle$)

These constructions concern orthogonal symmetries, central symmetries, orthogonal projections and translations. Several options allow the adjustment of the constructions. The idea of this macro comes from **Yves Combe**.

options	default	definition
reflection= over pt1--pt2	reflection	constructions of orthogonal symmetry
symmetry=center pt	reflection	constructions of central symmetry
projection=onto pt1--pt2	reflection	constructions of a projection
translation=from pt1 to pt2	reflection	constructions of a translation
K	1	circle within a triangle
length	1	arc length
ratio	.5	arc length ratio
gap	2	placing the point of construction
size	1	radius of an arc (see bisector)

33.2.1. Example of the use of `\tkzShowTransformation`

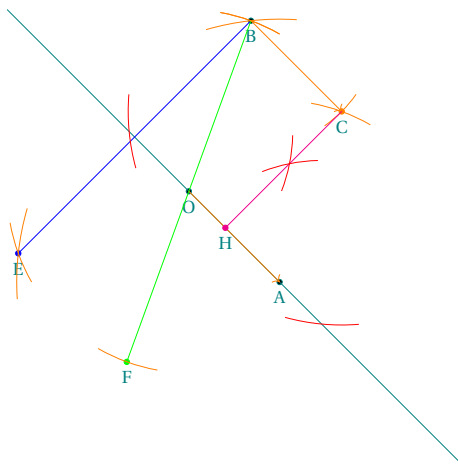

```

\begin{tikzpicture}[scale=.6]
  \tkzDefPoint(0,0){O} \tkzDefPoint(2,-2){A}
  \tkzDefPoint(70:4){B} \tkzDrawPoints(A,O,B)
  \tkzLabelPoints(A,O,B)
  \tkzDrawLine[add= 2 and 2](O,A)
  \tkzDefPointBy[translation=from O to A](B)
  \tkzGetPoint{C}
  \tkzDrawPoint[color=orange](C) \tkzLabelPoints(C)
  \tkzShowTransformation[translation=from O to A,%
    length=2](B)
  \tkzDrawSegments[->,color=orange](O,A B,C)
  \tkzDefPointBy[reflection=over O--A](B) \tkzGetPoint{E}
  \tkzDrawSegment[blue](B,E)
  \tkzDrawPoint[color=blue](E)\tkzLabelPoints(E)
  \tkzShowTransformation[reflection=over O--A,size=2](B)
  \tkzDefPointBy[symmetry=center O](B) \tkzGetPoint{F}
  \tkzDrawSegment[color=green](B,F)
  \tkzDrawPoint[color=green](F)\tkzLabelPoints(F)
  \tkzShowTransformation[symmetry=center O,%
    length=2](B)
  \tkzDefPointBy[projection=onto O--A](C)
  \tkzGetPoint{H}
  \tkzDrawSegments[color=magenta](C,H)
  \tkzDrawPoint[color=magenta](H)\tkzLabelPoints(H)
  \tkzShowTransformation[projection=onto O--A,%
    color=red,size=3,gap=-2](C)
\end{tikzpicture}

```

33.2.2. Another example of the use of `\tkzShowTransformation`

You'll find this figure again, but without the construction features.

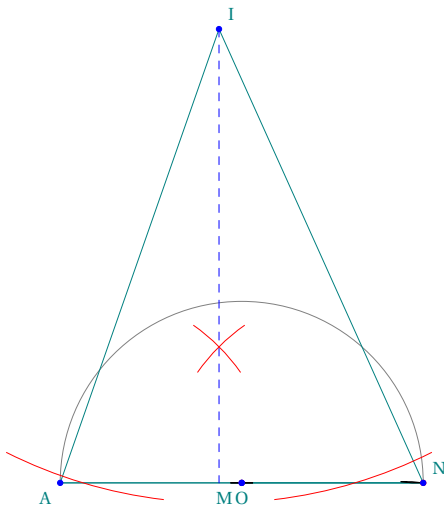

```

\begin{tikzpicture}[scale=.6]
  \tkzDefPoints{O/Q/A,8/Q/B,3.5/1Q/I}
  \tkzDefMidPoint(A,B) \tkzGetPoint{O}
  \tkzDefPointBy[projection=onto A--B](I)
    \tkzGetPoint{J}
  \tkzInterLC(I,A)(O,A) \tkzGetPoints{M}{M'}
  \tkzInterLC(I,B)(O,A) \tkzGetPoints{N}{N'}
  \tkzDefMidPoint(A,B) \tkzGetPoint{M}
  \tkzDrawSemiCircle(M,B)
  \tkzDrawSegments(I,A I,B A,B B,M A,N)
  \tkzMarkRightAngles(A,M,B A,N,B)
  \tkzDrawSegment[style=dashed,color=blue](I,J)
  \tkzShowTransformation[projection=onto A--B,
    color=red,size=3,gap=-3](I)
  \tkzDrawPoints[color=red](M,N)
  \tkzDrawPoints[color=blue](O,A,B,I,M)
  \tkzLabelPoints(O)
  \tkzLabelPoints[above right](N,I)
  \tkzLabelPoints[below left](M,A)
\end{tikzpicture}

```

34. Protractor

Based on an idea by Yves Combe, the following macro allows you to draw a protractor. The operating principle is even simpler. Just name a half-line (a ray). The protractor will be placed on the origin O , the direction of the half-line is given by A . The angle is measured in the direct direction of the trigonometric circle.

34.1. The macro `\tkzProtractor`

```
\tkzProtractor[(local options)]( $O,A$ )
```

options	default	definition
<code>lw</code>	<code>0.4 pt</code>	line thickness
<code>scale</code>	<code>1</code>	ratio: adjusts the size of the protractor
<code>return</code>	<code>false</code>	trigonometric circle indirect

34.1.1. The circular protractor

Measuring in the forward direction

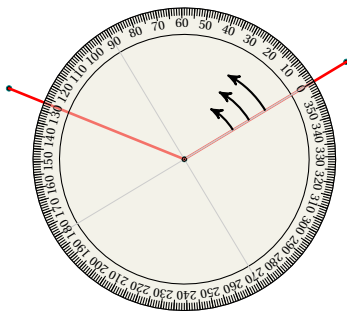

```

\begin{tikzpicture}[scale=.5]
  \tkzDefPoint(2,0){A}\tkzDefPoint(0,0){O}
  \tkzDefShiftPoint[A](31:5){B}
  \tkzDefShiftPoint[A](158:5){C}
  \tkzDrawPoints(A,B,C)
  \tkzDrawSegments[color = red,
    line width = 1pt](A,B A,C)
  \tkzProtractor[scale = 1](A,B)
\end{tikzpicture}

```

34.1.2. The circular protractor, transparent and returned

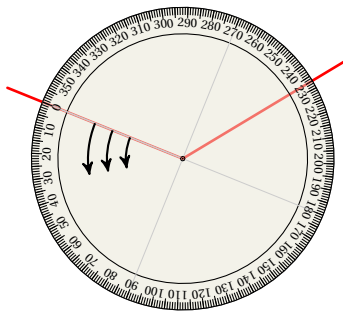

```
\begin{tikzpicture}[scale=.5]
  \tkzDefPoint(2,3){A}
  \tkzDefShiftPoint[A](31:5){B}
  \tkzDefShiftPoint[A](158:5){C}
  \tkzDrawSegments[color=red,line width=1pt](A,B A,C)
  \tkzProtractor[return](A,C)
\end{tikzpicture}
```

35. Miscellaneous tools and mathematical tools

35.1. Duplicate a segment

This involves constructing a segment on a given half-line of the same length as a given segment.

```
\tkzDuplicateSegment(\langle pt1,pt2\rangle)(\langle pt3,pt4\rangle){\langle pt5\rangle}
```

This involves creating a segment on a given half-line of the same length as a given segment. It is in fact the definition of a point. `\tkzDuplicateSegment` is the new name of `\tkzDuplicateLen`.

arguments	example	explanation
<code>(pt1,pt2)(pt3,pt4){pt5}</code>	<code>\tkzDuplicateSegment(A,B)(E,F){C}</code>	$AC=EF$ and $C \in [AB]$

The macro `\tkzDuplicateLength` is identical to this one.

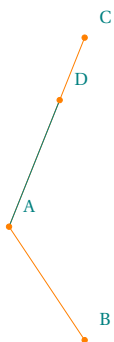
35.1.1. Use of `\tkzDuplicateSegment`

```
\begin{tikzpicture}[scale=.5]
  \tkzDefPoints{0/0/A,2/-3/B,2/5/C}
  \tkzDuplicateSegment(A,B)(A,C)
  \tkzGetPoint{D}
  \tkzDrawSegments[new](A,B A,C)
  \tkzDrawSegment[teal](A,D)
  \tkzDrawPoints[new](A,B,C,D)
  \tkzLabelPoints[above right=3pt](A,B,C,D)
\end{tikzpicture}
```

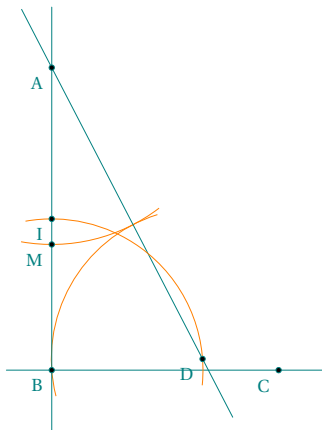
35.1.2. Proportion of gold with `\tkzDuplicateSegment`

```
\begin{tikzpicture}[rotate=-90,scale=.4]
\tkzDefPoints{0/0/A,10/0/B}
\tkzDefMidPoint(A,B)
\tkzGetPoint{I}
\tkzDefPointWith[orthogonal,K=-.75](B,A)
\tkzGetPoint{C}
\tkzInterLC(B,C)(B,I)\tkzGetSecondPoint{D}
\tkzDuplicateSegment(B,D)(D,A)\tkzGetPoint{E}
\tkzInterLC(A,B)(A,E)\tkzGetPoints{N}{M}
\tkzDrawArc[orange,delta=10](D,E)(B)
\tkzDrawArc[orange,delta=10](A,M)(E)
\tkzDrawLines(A,B B,C A,D)
\tkzDrawArc[orange,delta=10](B,D)(I)
\tkzDrawPoints(A,B,D,C,M,I)
\tkzLabelPoints[below left](A,B,D,C,M,I)
\end{tikzpicture}
```

35.1.3. Golden triangle or sublime triangle

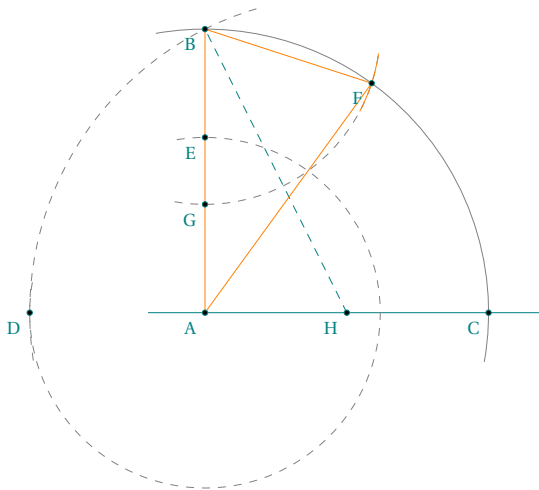

```
\begin{tikzpicture}[scale=.75]
\tkzDefPoints{0/0/A,5/0/C,0/5/B}
\tkzDefMidPoint(A,C)\tkzGetPoint{H}
\tkzDuplicateSegment(H,B)(H,A)\tkzGetPoint{D}
\tkzDuplicateSegment(A,D)(A,B)\tkzGetPoint{E}
\tkzDuplicateSegment(A,D)(B,A)\tkzGetPoint{G}
\tkzInterCC(A,C)(B,G)\tkzGetSecondPoint{F}
\tkzDrawLine(A,C)
\tkzDrawArc(A,C)(B)
\begin{scope}[arc style/.style={color=gray,%
style=dashed}]
\tkzDrawArc(H,B)(D)
\tkzDrawArc(A,D)(B)
\tkzDrawArc(B,G)(F)
\end{scope}
\tkzDrawSegment[dashed](H,B)
\tkzCompass(B,F)
\tkzDrawPolygon[new](A,B,F)
\tkzDrawPoints(A,...,H)
\tkzLabelPoints[below left](A,...,H)
\end{tikzpicture}
```

35.2. Segment length `\tkzCalcLength`

There's an option in TikZ named `vecLen`. This option is used to calculate AB if A and B are two points. The only problem for me is that the version of TikZ is not accurate enough in some cases. My version uses the `xfp` package and is slower, but more accurate.

```
\tkzCalcLength[local options](pt1,pt2)
```

You can store the result with the macro `\tkzGetLength` for example `\tkzGetLength{dAB}` defines the macro `\dAB`.

arguments	example	explanation
<code>(pt1,pt2){name of macro}</code>	<code>\tkzCalcLength(A,B)</code>	<code>\dAB</code> gives AB in cm

Only one option

options	default	example
cm	true	<code>\tkzCalcLength(A,B)</code> After <code>\tkzGetLength{dAB}</code> <code>\dAB</code> gives AB in cm

35.2.1. Compass square construction

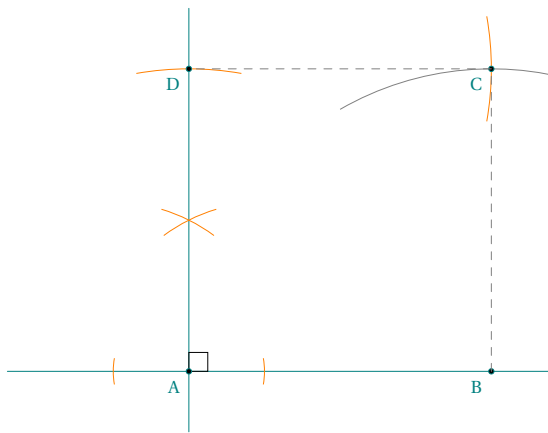

```

\begin{tikzpicture}[scale=1]
  \tkzDefPoint(0,0){A} \tkzDefPoint(4,0){B}
  \tkzCalcLength(A,B)\tkzGetLength{dAB}
  \tkzDefLine[perpendicular=through A](A,B)
  \tkzGetPoint{D}
  \tkzDefPointWith[orthogonal,K=-1](B,A)
  \tkzGetPoint{F}
  \tkzGetPoint{C}
  \tkzDrawLine[add= .6 and .2](A,B)
  \tkzDrawLine(A,D)
  \tkzShowLine[orthogonal=through A,gap=2](A,B)
  \tkzMarkRightAngle(B,A,D)
  \tkzCompass(A,D D,C)
  \tkzDrawArc[R](B,\dAB)(80,110)
  \tkzDrawPoints(A,B,C,D)
  \tkzDrawSegments[color=gray,style=dashed](B,C C,D)
  \tkzLabelPoints[below left](A,B,C,D)
\end{tikzpicture}

```

35.2.2. Example

The macro `\tkzDefCircle[radius](A,B)` defines the radius that we retrieve with `\tkzGetLength`, this result is in cm.

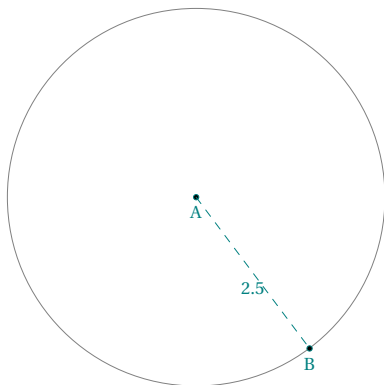

```

\begin{tikzpicture}[scale=.5]
  \tkzDefPoint(0,0){A}
  \tkzDefPoint(3,-4){B}
  \tkzDefMidPoint(A,B) \tkzGetPoint{M}
  \tkzCalcLength(M,B)\tkzGetLength{rAB}
  \tkzDrawCircle(A,B)
  \tkzDrawPoints(A,B)
  \tkzLabelPoints(A,B)
  \tkzDrawSegment[dashed](A,B)
  \tkzLabelSegment(A,B){$\pgfmathprintnumber{\rAB}$}
\end{tikzpicture}

```

35.3. Transformation from pt to cm or cm to pt

Not sure if this is necessary and it is only a division by 28.45274 and a multiplication by the same number. The macros are:

```
\tkzpttocm(<number>){<name of macro>}
```

The result is stored in a macro.

arguments	example	explanation
<code>(number){name of macro}</code>	<code>\tkzpttocm(120){len}</code>	<code>\len</code> gives a number of tkznamecm

You'll have to use `\len` along with `cm`.

35.4. Change of unit

```
\tkzcmtopt(<number>){<name of macro>}
```

The result is stored in a macro.

arguments	example	explanation
(number){name of macro}	<code>\tkzcmtopt(5){len}</code>	<code>\len</code> length in pts

The result can be used with `\len pt`

35.5. Get point coordinates

```
\tkzGetPointCoord(<A>){<name of macro>}
```

arguments	example	explanation
(point){name of macro}	<code>\tkzGetPointCoord(A){A}</code>	<code>\Ax</code> and <code>\Ay</code> give coordinates for A

Stores in two macros the coordinates of a point. If the name of the macro is `p`, then `\px` and `\py` give the coordinates of the chosen point with the `cm` as unit.

35.5.1. Coordinate transfer with `\tkzGetPointCoord`

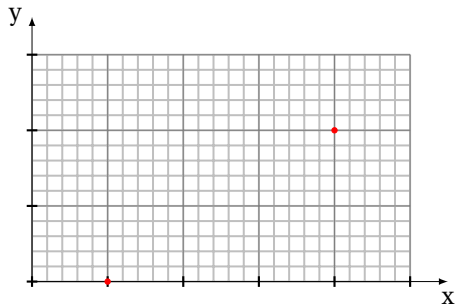

```
\begin{tikzpicture}
\tkzInit[xmax=5,ymax=3]
\tkzGrid[sub,orange]
\tkzDrawX \tkzDrawY
\tkzDefPoint(1,0){A}
\tkzDefPoint(4,2){B}
\tkzGetPointCoord(A){a}
\tkzGetPointCoord(B){b}
\tkzDefPoint(\ax,\ay){C}
\tkzDefPoint(\bx,\by){D}
\tkzDrawPoints[color=red](C,D)
\end{tikzpicture}
```

35.5.2. Sum of vectors with `\tkzGetPointCoord`

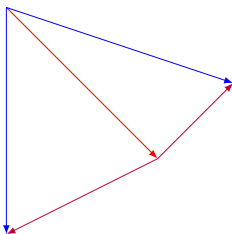

```
\begin{tikzpicture}[>=latex]
\tkzDefPoint(1,4){a}
\tkzDefPoint(3,2){b}
\tkzDefPoint(1,1){c}
\tkzDrawSegment[->,red](a,b)
\tkzGetPointCoord(c){c}
\draw[>=blue,blue,->](a) -- ([shift=(b)]\cx,\cy) ;
\draw[>=purple,purple,->](b) -- ([shift=(b)]\cx,\cy) ;
\tkzDrawSegment[->,blue](a,c)
\tkzDrawSegment[->,purple](b,c)
\end{tikzpicture}
```

35.6. Swap labels of points

<code>\tkzSwapPoints(<i>pt1,pt2</i>)</code>		
arguments	example	explanation
<code>(pt1,pt2)</code>	<code>\tkzSwapPoints(A,B)</code>	now A has the coordinates of B <i>The points have exchanged their coordinates.</i>

35.6.1. Use of `\tkzSwapPoints`

• A	<pre> \begin{tikzpicture} \tkzDefPoints{0/Q/0,5/-1/A,2/2/B} \tkzSwapPoints(A,B) \tkzDrawPoints(O,A,B) \tkzLabelPoints(O,A,B) \end{tikzpicture} </pre>
• O	
	• B

35.7. Dot Product

In Euclidean geometry, the dot product of the Cartesian coordinates of two vectors is widely used.

<code>\tkzDotProduct(<i>pt1,pt2,pt3</i>)</code>		
arguments	example	explanation
<code>(pt1,pt2,pt3)</code>	<code>\tkzDotProduct(A,B,C)</code>	the result is $\overrightarrow{AB} \cdot \overrightarrow{AC}$ <i>The result is a number that can be retrieved with <code>\tkzGetResult</code>.</i>

35.7.1. Simple example

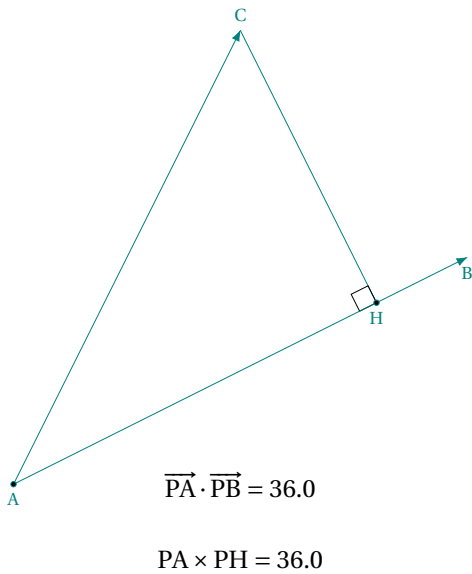

```
\begin{tikzpicture}
  \tkzDefPoints{-2/-3/A,4/0/B,1/3/C}
  \tkzDefPointBy[projection= onto A--B](C)
  \tkzGetPoint{H}
  \tkzDrawSegment(C,H)
  \tkzMarkRightAngle(C,H,A)
  \tkzDrawSegments[vector style](A,B A,C)
  \tkzDrawPoints(A,H) \tkzLabelPoints(A,B,H)
  \tkzLabelPoints[above](C)
  \tkzDotProduct(A,B,C) \tkzGetResult{pabc}
  \pgfmathparse{round(10*\pabc)/10}
  \let\pabc\pgfmathresult
  \node at (1,-3) {%
    $\overrightarrow{PA} \cdot \overrightarrow{PB} = \pabc$};
  \tkzDotProduct(A,H,B) \tkzGetResult{phab}
  \pgfmathparse{round(10*\phab)/10}
  \let\phab\pgfmathresult
  \node at (1,-4) {$PA \times PH = \phab $};
\end{tikzpicture}
```

35.7.2. Cocyclic points

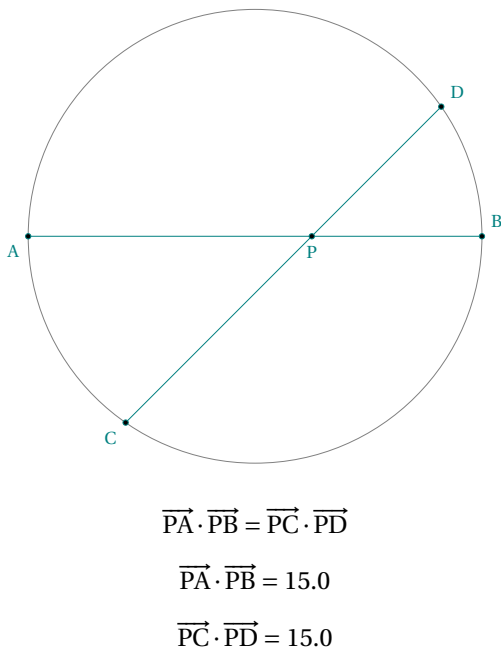

```
\begin{tikzpicture}[scale=.75]
  \tkzDefPoints{1/2/0,5/2/B,2/2/P,3/3/Q}
  \tkzInterLC[common=B](0,B)(0,B) \tkzGetFirstPoint{A}
  \tkzInterLC[common=B](P,Q)(0,B) \tkzGetPoints{C}{D}
  \tkzDrawCircle(0,B)
  \tkzDrawSegments(A,B C,D)
  \tkzDrawPoints(A,B,C,D,P)
  \tkzLabelPoints(P)
  \tkzLabelPoints[below left](A,C)
  \tkzLabelPoints[above right](B,D)
  \tkzDotProduct(P,A,B) \tkzGetResult{pab}
  \pgfmathparse{round(10*\pab)/10}
  \let\pab\pgfmathresult
  \tkzDotProduct(P,C,D) \tkzGetResult{pcd}
  \pgfmathparse{round(10*\pcd)/10}
  \let\pcd\pgfmathresult
  \node at (1,-3) {%
    $\overrightarrow{PA} \cdot \overrightarrow{PB} = $
    $\overrightarrow{PC} \cdot \overrightarrow{PD}$};
  \node at (1,-4) {%
    {$\overrightarrow{PA} \cdot \overrightarrow{PB} = \pab$};
  \node at (1,-5) {%
    $\overrightarrow{PC} \cdot \overrightarrow{PD} = \pcd$};
\end{tikzpicture}
```

35.8. Power of a point with respect to a circle

<code>\tkzPowerCircle(<pt1>)(<pt2,pt3>)</code>		
arguments	example	explanation
<code>(pt1)(pt2,pt3)</code>	<code>\tkzPowerCircle(A)(O,M)</code>	power of A with respect to the circle (O,A) <i>The result is a number that represents the power of a point with respect to a circle.</i>

35.8.1. Power from the radical axis

In this example, the radical axis (EF) has been drawn. A point H has been chosen on (EF) and the power of the point H with respect to the circle of center A has been calculated as well as PS^2 . You can check that the power of H with respect to the circle of center C as well as HS^2 , HT^2 , HT'^2 give the same result.

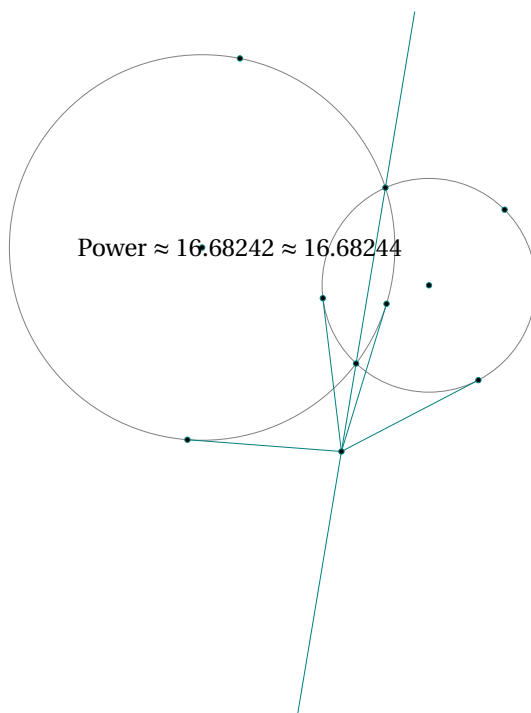

```
\begin{tikzpicture}[scale=.5]
\tkzDefPoints{-1/0/A,0/5/B,5/-1/C,7/1/D}
\tkzDrawCircles(A,B C,D)
\tkzDefRadicalAxis(A,B)(C,D) \tkzGetPoints{E}{F}
\tkzDrawLine[add=1 and 2](E,F)
\tkzDefPointOnLine[pos=1.5](E,F) \tkzGetPoint{H}
\tkzDefLine[tangent from = H](A,B)\tkzGetPoints{T}{T'}
\tkzDefLine[tangent from = H](C,D)\tkzGetPoints{S}{S'}
\tkzDrawSegments(H,T H,T' H,S H,S')
\tkzDrawPoints(A,B,C,D,E,F,H,T,T',S,S')
\tkzPowerCircle(H)(A,B) \tkzGetResult{pw}
\tkzDotProduct(H,S,S) \tkzGetResult{phtt}
\node {Power $\approx \backslashpw \approx \backslashphtt$};
\end{tikzpicture}
```

35.9. Radical axis

In geometry, the radical axis of two non-concentric circles is the set of points whose power with respect to the circles are equal. Here `\tkzDefRadicalAxis(A,B)(C,D)` gives the radical axis of the two circles $\mathcal{C}(A,B)$ and $\mathcal{C}(C,D)$.

<code>\tkzDefRadicalAxis(<pt1,pt2>)(<pt3,pt4>)</code>		
arguments	example	explanation
<code>(pt1,pt2)(pt3,pt4)</code>	<code>\tkzDefRadicalAxis(A,B)(C,D)</code>	Two circles with centers A and C <i>The result is two points of the radical axis.</i>

35.9.1. Two circles disjoint

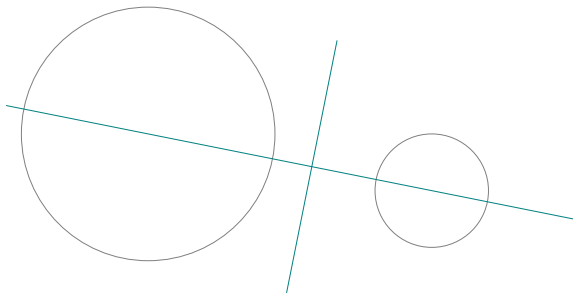

```
\begin{tikzpicture}[scale=.75]
  \tkzDefPoints{-1/0/A,0/2/B,4/-1/C,4/0/D}
  \tkzDrawCircles(A,B C,D)
  \tkzDefRadicalAxis(A,B)(C,D)
  \tkzGetPoints{E}{F}
  \tkzDrawLine[add=1 and 2](E,F)
  \tkzDrawLine[add=.5 and .5](A,C)
\end{tikzpicture}
```

35.10. Two intersecting circles

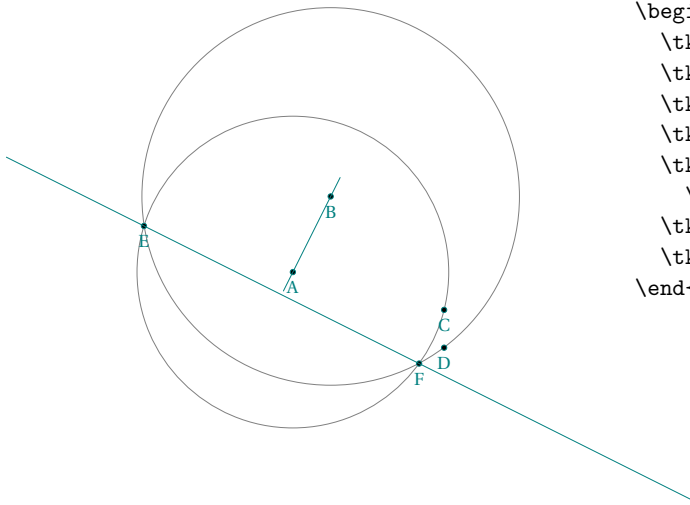

```
\begin{tikzpicture}[scale=.5]
  \tkzDefPoints{-1/0/A,0/2/B,3/-1/C,3/-2/D}
  \tkzDrawCircles(A,C B,D)
  \tkzDefRadicalAxis(A,C)(B,D)
  \tkzGetPoints{E}{F}
  \tkzDrawPoints(A,B,C,D,E,F)
  \tkzLabelPoints(A,B,C,D,E,F)
  \tkzDrawLine[add=.5 and 1](E,F)
  \tkzDrawLine[add=.25 and .25](A,B)
\end{tikzpicture}
```

35.11. Two externally tangent circles

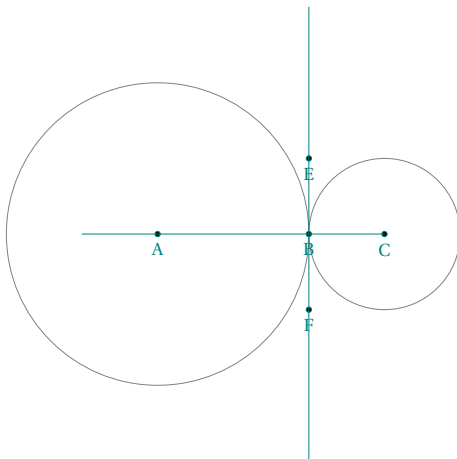

```
\begin{tikzpicture}[scale=.5]
  \tkzDefPoints{0/0/A,4/0/B,6/0/C}
  \tkzDrawCircles(A,B C,B)
  \tkzDefRadicalAxis(A,B)(C,B)
  \tkzGetPoints{E}{F}
  \tkzDrawPoints(A,B,C,E,F)
  \tkzLabelPoints(A,B,C,E,F)
  \tkzDrawLine[add=1 and 1](E,F)
  \tkzDrawLine[add=.5 and .5](A,B)
\end{tikzpicture}
```

35.12. Two circles tangent internally

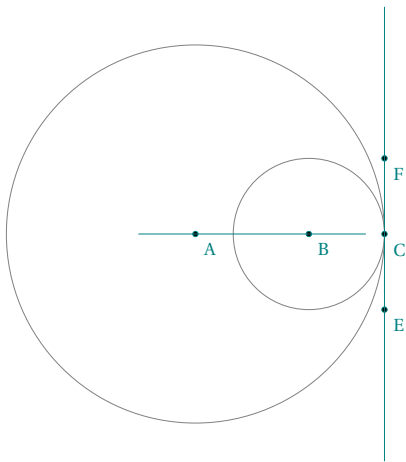

```
\begin{tikzpicture}[scale=.5]
  \tkzDefPoints{0/0/A,3/0/B,5/0/C}
  \tkzDrawCircles(A,C B,C)
  \tkzDefRadicalAxis(A,C)(B,C)
  \tkzGetPoints{E}{F}
  \tkzDrawPoints(A,B,C,E,F)
  \tkzLabelPoints[below right](A,B,C,E,F)
  \tkzDrawLine[add=1 and 1](E,F)
  \tkzDrawLine[add=.5 and .5](A,B)
\end{tikzpicture}
```

35.12.1. Three circles

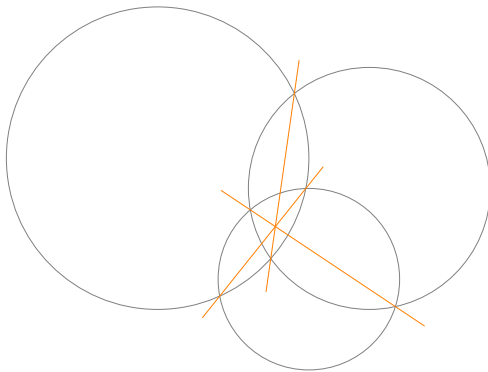

```
\begin{tikzpicture}[scale=.4]
  \tkzDefPoints{0/0/A,5/0/a,7/-1/B,3/-1/b,5/-4/C,2/-4/c}
  \tkzDrawCircles(A,a B,b C,c)
  \tkzDefRadicalAxis(A,a)(B,b) \tkzGetPoints{i}{j}
  \tkzDefRadicalAxis(A,a)(C,c) \tkzGetPoints{k}{l}
  \tkzDefRadicalAxis(C,c)(B,b) \tkzGetPoints{m}{n}
  \tkzDrawLines[new](i,j k,l m,n)
\end{tikzpicture}
```

35.13. `\tkzIsLinear`, `\tkzIsOrtho`

`\tkzIsLinear(\langle pt1,pt2,pt3 \rangle)`

arguments	example	explanation
\langle pt1,pt2,pt3 \rangle	<code>\tkzIsLinear(A,B,C)</code>	A,B,C aligned ?

`\tkzIsLinear` allows to test the alignment of the three points pt1,pt2,pt3.

`\tkzIsOrtho(\langle pt1,pt2,pt3 \rangle)`

arguments	example	explanation
\langle pt1,pt2,pt3 \rangle	<code>\tkzIsOrtho(A,B,C)</code>	$(AB) \perp (AC)$?

`\tkzIsOrtho` allows to test the orthogonality of lines $(pt1pt2)$ and $(pt1pt3)$.

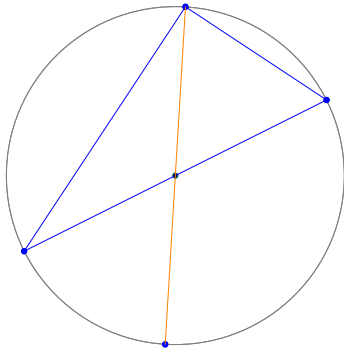
35.13.1. Use of `\tkzIsOrtho` and `\tkzIsLinear`

```

\begin{tikzpicture}
\tkzDefPoints{1/-2/A,5/0/B}
\tkzDefCircle[diameter](A,B) \tkzGetPoint{O}
\tkzDrawCircle(O,A)
\tkzDefPointBy[rotation= center O angle 60](B)
\tkzGetPoint{C}
\tkzDefPointBy[rotation= center O angle 60](A)
\tkzGetPoint{D}
\tkzDrawCircle(O,A)
\tkzDrawPoints(A,B,C,D,O)
\tkzIsOrtho(C,A,B)
\iftkzOrtho
\tkzDrawPolygon[blue](A,B,C)
\tkzDrawPoints[blue](A,B,C,D)
\else
\tkzDrawPoints[red](A,B,C,D)
\fi
\tkzIsLinear(O,C,D)
\iftkzLinear
\tkzDrawSegment[orange](C,D)
\fi
\end{tikzpicture}

```

Part VIII.

Working with style

36. Predefined styles

The way to proceed will depend on your use of the package. A method that seems to me to be correct is to use as much as possible predefined styles in order to separate the content from the form. This method will be the right one if you plan to create a document (like this documentation) with many figures. We will see how to define a global style for a document. We will see how to use a style locally.

The file `tkz-euclide.cfg` contains the predefined styles of the main objects. Among these the most important are points, lines, segments, circles, arcs and compass traces. If you always use the same styles and if you create many figures then it is interesting to create your own styles. To do this you need to know what features you can modify. It will be necessary to know some notions of TikZ.

The predefined styles are global styles. They exist before the creation of the figures. It is better to avoid changing them between two figures. On the other hand these styles can be modified in a figure temporarily. There the styles are defined locally and do not influence the other figures.

For the document you are reading here is how I defined the different styles.

```
\tkzSetUpColors[background=white,text=black]
\tkzSetUpPoint[size=2,color=teal]
\tkzSetUpLine[line width=.4pt,color=teal]
\tkzSetUpCompass[color=orange, line width=.4pt,delta=10]
\tkzSetUpArc[color=gray,line width=.4pt]
\tkzSetUpStyle[orange]{new}
```

The macro `\tkzSetUpColors` allows you to set the background color as well as the text color. If you don't use it, the colors of your document will be used as well as the fonts. Let's see how to define the styles of the main objects.

37. Points style

This is how the points are defined :

```
\tikzset{point style/.style = {%
  draw      = \tkz@euc@pointcolor,
  inner sep = 0pt,
  shape     = \tkz@euc@pointshape,
  minimum size = \tkz@euc@pointsize,
  fill      = \tkz@euc@pointcolor}}
```

It is of course possible to use `\tikzset` but you can use a macro provided by the package. You can use the macro `\tkzSetUpPoint` globally or locally, Let's look at this possibility.

37.1. Use of `\tkzSetUpPoint`

<code>\tkzSetUpPoint[(local options)]</code>		
options	default	definition
color	black	point color
size	3	point size
fill	black!50	inside point color
shape	circle	point shape circle, cross or cross out

37.1.1. Global style or local style

First of all here is a figure created with the styles of my documentation, then the style of the points is modified within the environment `tikzpicture`.

You can use the macro `\tkzSetUpPoint` globally or locally, If you place this macro in your preamble or before your first figure then the point style will be valid for all figures in your document. It will be possible to use another style locally by using this command within an environment `tikzpicture`.

Let's look at this possibility.

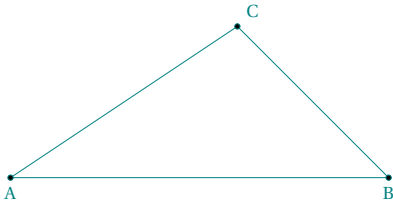

```
\begin{tikzpicture}
  \tkzDefPoints{0/0/A,5/0/B,3/2/C,3/1/D}
  \tkzDrawPolygon(A,B,C)
  \tkzDrawPoints(A,B,C)
  \tkzLabelPoints(A,B)
  \tkzLabelPoints[above right](C)
\end{tikzpicture}
```

37.1.2. Local style

The style of the points is modified locally in the second figure

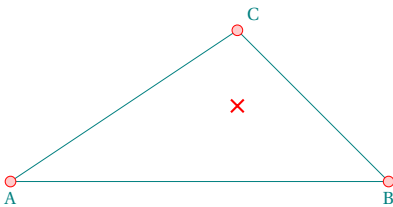

```
\begin{tikzpicture}
  \tkzSetUpPoint[size=4,color=red,fill=red!20]
  \tkzDefPoints{0/0/A,5/0/B,3/2/C,3/1/D}
  \tkzDrawPolygon(A,B,C)
  \tkzDrawPoints(A,B,C)
  \tkzDrawPoint[shape=cross out,thick](D)
  \tkzLabelPoints(A,B)
  \tkzLabelPoints[above right](C)
\end{tikzpicture}
```

37.1.3. Style and scope

The points get back the initial style. Point D has a new style limited by the environment scope. It is also possible to use `{...}` or `\begin{group} ... \end{group}`. It is also possible to use `{...}` or `\begin{group} ... \end{group}`.

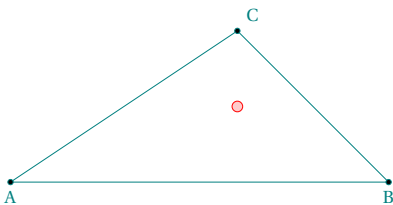

```
\begin{tikzpicture}
  \tkzDefPoints{0/0/A,5/0/B,3/2/C,3/1/D}
  \tkzDrawPolygon(A,B,C)
  \tkzDrawPoints(A,B,C)
  \begin{scope}
    \tkzSetUpPoint[size=4,color=red,fill=red!20]
    \tkzDrawPoint(D)
  \end{scope}
  \tkzLabelPoints(A,B)
  \tkzLabelPoints[above right](C)
\end{tikzpicture}
```

37.1.4. Simple example with `\tkzSetUpPoint`

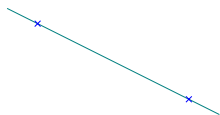

```
\begin{tikzpicture}
  \tkzSetUpPoint[shape = cross out,color=blue]
  \tkzDefPoint(2,1){A}
  \tkzDefPoint(4,0){B}
  \tkzDrawLine(A,B)
  \tkzDrawPoints(A,B)
\end{tikzpicture}
```

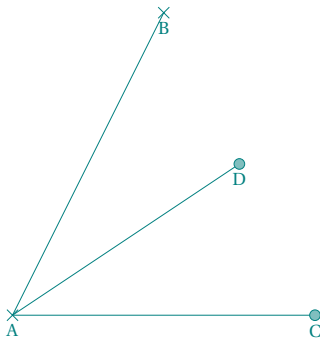
37.1.5. Use of `\tkzSetUpPoint` inside a group

```
\begin{tikzpicture}
\tkzDefPoints{0/0/A,2/4/B,4/0/C,3/2/D}
\tkzDrawSegments(A,B A,C A,D)
{\tkzSetUpPoint[shape=cross out,
fill= teal!50,
size=4,color=teal]
\tkzDrawPoints(A,B)}
\tkzSetUpPoint[fill= teal!50,size=4,
color=teal]
\tkzDrawPoints(C,D)
\tkzLabelPoints(A,B,C,D)
\end{tikzpicture}
```

38. Lines style

You have several possibilities to change the style of a line. You can modify the style of a line with `\tkzSetUpLine` or directly modify the style of the lines with `\tikzset{line style/.style = ... }`

Reminder about `line width`: There are a number of predefined styles that provide more “natural” ways of setting the line width. You can also redefine these styles.

predefined style	value of line width
ultra thin	0.1 pt
very thin	0.2 pt
thin	0.4 pt
semithick	0.6 pt
thick	0.8 pt
very thick	1.2 pt
ultra thick	1.6 pt

38.1. Use of `\tkzSetUpLine`

It is a macro that allows you to define the style of all the lines.

<code>\tkzSetUpLine[(local options)]</code>		
options	default	definition
color	black	colour of the construction lines
line width	0.4pt	thickness of the construction lines
style	solid	style of construction lines
add	.2 and .2	changing the length of a line segment

38.1.1. Change line width

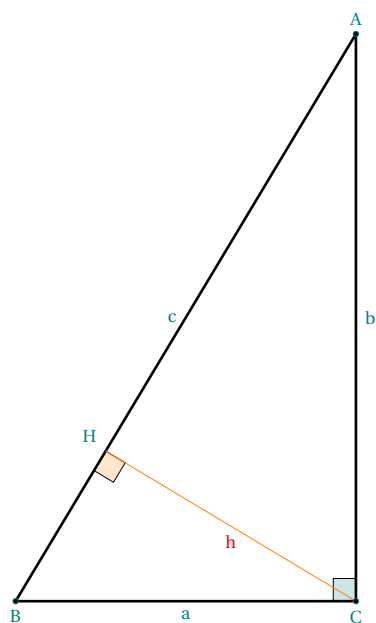

```

\begin{tikzpicture}[scale=.75]
\tkzSetUpLine[line width=1pt]
\begin{scope}[rotate=-90]
\tkzDefPoints{0/6/A,10/0/B,10/6/C}
\tkzDefPointBy[projection = onto B--A](C)
\tkzGetPoint{H}
\tkzMarkRightAngle[size=.4,
fill=teal!20](B,C,A)
\tkzMarkRightAngle[size=.4,
fill=orange!20](B,H,C)
\tkzDrawPolygon(A,B,C)
\tkzDrawSegment[new](C,H)
\end{scope}
\tkzLabelSegment[below](C,B){$a$}
\tkzLabelSegment[right](A,C){$b$}
\tkzLabelSegment[left](A,B){$c$}
\tkzLabelSegment[color=red](C,H){$h$}
\tkzDrawPoints(A,B,C)
\tkzLabelPoints[above left](H)
\tkzLabelPoints(B,C)
\tkzLabelPoints[above](A)
\end{tikzpicture}

```

38.1.2. Change style of line

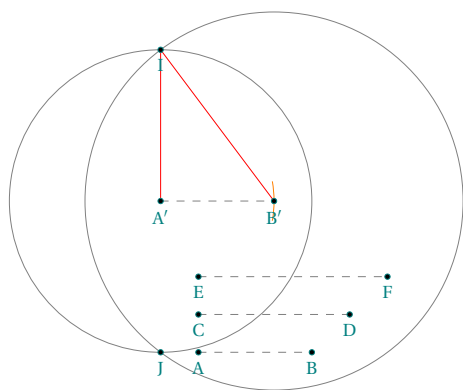

```

\begin{tikzpicture}[scale=.5]
\tikzset{line style/.style = {color = gray,
style=dashed}}
\tkzDefPoints{1/0/A,4/0/B,1/1/C,5/1/D}
\tkzDefPoints{1/2/E,6/2/F,0/4/A',3/4/B'}
\tkzCalcLength(C,D)
\tkzGetLength{rCD}
\tkzCalcLength(E,F)
\tkzGetLength{rEF}
\tkzInterCC[R](A',\rCD)(B',\rEF)
\tkzGetPoints{I}{J}
\tkzDrawLine(A',B')
\tkzCompass(A',B')
\tkzDrawSegments(A,B C,D E,F)
\tkzDefCircle[R](A',\rCD) \tkzGetPoint{a'}
\tkzDefCircle[R](B',\rEF) \tkzGetPoint{b'}
\tkzDrawCircles(A',a' B',b')
\begin{scope}
\tkzSetUpLine[color=red]
\tkzDrawSegments(A',I B',I)
\end{scope}
\tkzDrawPoints(A,B,C,D,E,F,A',B',I,J)
\tkzLabelPoints(A,B,C,D,E,F,A',B',I,J)
\end{tikzpicture}

```

38.1.3. Example 3: extend lines

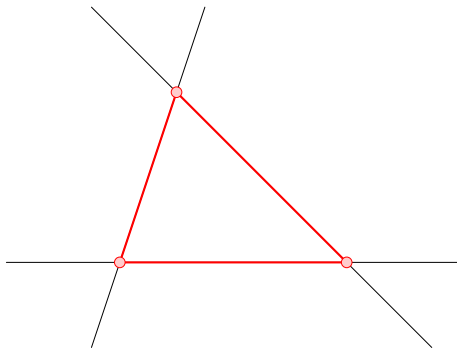

```

\begin{tikzpicture}[scale=.75]
\tkzSetUpLine[add=.5 and .5]
\tkzDefPoints{0/0/A,4/0/B,1/3/C}
\tkzDrawLines(A,B B,C A,C)
\tkzDrawPolygon[red,thick](A,B,C)
\tkzSetUpPoint[size=4,color=red,fill=red!20]
\tkzDrawPoints(A,B,C)
\end{tikzpicture}

```

39. Arc style

39.1. The macro \tkzSetUpArc

\tkzSetUpArc[⟨local options⟩]		
options	default	definition
color	black	colour of the lines
line width	0.4pt	thickness of the lines
style	solid	style of construction lines

39.1.1. Use of \tkzSetUpArc

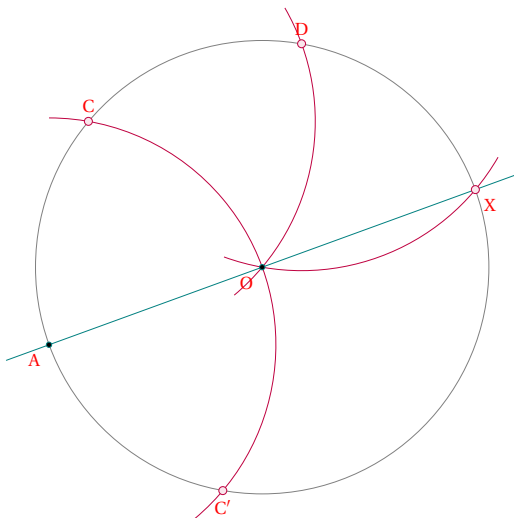

```

\begin{tikzpicture}
\def\r{3} \def\angle{200}
\tkzSetUpArc[delta=10,color=purple,line width=.2pt]
\tkzSetUpLabel[font=\scriptsize,red]
\tkzDefPoint(0,0){O}
\tkzDefPoint(\angle:\r){A}
\tkzInterCC(O,A)(A,0) \tkzGetPoints{C'}{C}
\tkzInterCC(O,A)(C,0) \tkzGetPoints{D'}{D}
\tkzInterCC(O,A)(D,0) \tkzGetPoints{X'}{X}
\tkzDrawCircle(O,A)
\tkzDrawArc(A,C')(C)
\tkzDrawArc(C,0)(D)
\tkzDrawArc(D,0)(X)
\tkzDrawLine[add=.1 and .1](A,X)
\tkzDrawPoints(O,A)
\tkzSetUpPoint[size=3,color=purple,fill=purple!10]
\tkzDrawPoints(C,C',D,X)
\tkzLabelPoints[below left](O,A)
\tkzLabelPoints[below](C')
\tkzLabelPoints[below right](X)
\tkzLabelPoints[above](C,D)
\end{tikzpicture}

```

40. Compass style, configuration macro `\tkzSetUpCompass`

The following macro will help to understand the construction of a figure by showing the compass traces necessary to obtain certain points.

40.1. The macro `\tkzSetUpCompass`

<code>\tkzSetUpCompass[<i>local options</i>]</code>		
options	default	definition
color	black	colour of the construction lines
line width	0.4pt	thickness of the construction lines
style	solid	style of lines : solid, dashed,dotted,...
delta	0	changes the length of the arc

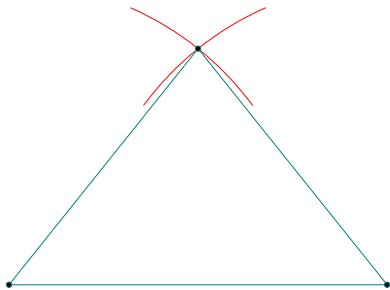
40.1.1. Use of `\tkzSetUpCompass`

```
\begin{tikzpicture}
  \tkzSetUpCompass[color=red,delta=15]
  \tkzDefPoint(1,1){A}
  \tkzDefPoint(6,1){B}
  \tkzInterCC[R](A,4)(B,4) \tkzGetPoints{C}{D}
  \tkzCompass(A,C)
  \tkzCompass(B,C)
  \tkzDrawPolygon(A,B,C)
  \tkzDrawPoints(A,B,C)
\end{tikzpicture}
```

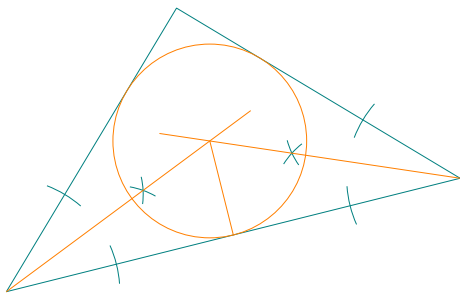
40.1.2. Use of `\tkzSetUpCompass` with `\tkzShowLine`

```
\begin{tikzpicture}[scale=.75]
  \tkzSetUpStyle[bisector,size=2,gap=3]{showbi}
  \tkzSetUpCompass[color=teal,line width=.3 pt]
  \tkzDefPoints{0/1/A, 8/3/B, 3/6/C}
  \tkzDrawPolygon(A,B,C)
  \tkzDefLine[bisector](B,A,C) \tkzGetPoint{a}
  \tkzDefLine[bisector](C,B,A) \tkzGetPoint{b}
  \tkzShowLine[showbi](B,A,C)
  \tkzShowLine[showbi](C,B,A)
  \tkzInterLL(A,a)(B,b) \tkzGetPoint{I}
  \tkzDefPointBy[projection= onto A--B](I)
  \tkzGetPoint{H}
  \tkzDrawCircle[new](I,H)
  \tkzDrawSegments[new](I,H)
  \tkzDrawLines[add=0 and .2,new](A,I B,I)
\end{tikzpicture}
```

41. Label style

41.1. The macro `\tkzSetUpLabel`

The macro `\tkzSetUpLabel` is used to define the style of the point labels.

```
\tkzSetUpStyle[⟨local options⟩]
```

The options are the same as those of TikZ

41.1.1. Use of \tkzSetUpLabel

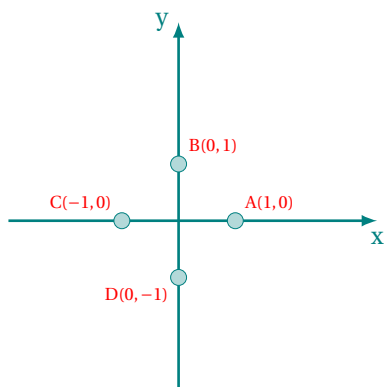

```
\begin{tikzpicture}[scale=.75]
  \tkzSetUpLabel[font=\scriptsize,red]
  \tkzSetUpStyle[line width=1pt,teal]{XY}
  \tkzInit[xmin=-3,xmax=3,ymin=-3,ymax=3]
  \tkzDrawX[noticks,XY]
  \tkzDrawY[noticks,XY]
  \tkzDefPoints{1/Q/A,0/1/B,-1/Q/C,0/-1/D}
  \tkzDrawPoints[teal,fill=teal!30,size=6](A,...,D)
  \tkzLabelPoint[above right](A){A(1,0)}
  \tkzLabelPoint[above right](B){B(0,1)}
  \tkzLabelPoint[above left](C){C(-1,0)}
  \tkzLabelPoint[below left](D){D(0,-1)}
\end{tikzpicture}
```

42. Own style

You can set your own style with \tkzSetUpStyle

42.1. The macro \tkzSetUpStyle

```
\tkzSetUpStyle[⟨local options⟩]
```

The options are the same as those of TikZ

42.1.1. Use of \tkzSetUpStyle

```
○ \begin{tikzpicture}
  A \tkzSetUpStyle[color=blue!20!black,fill=blue!20]{mystyle}
  \tkzDefPoint(0,0){O}
  ● \tkzDefPoint(0,1){A}
  ○ \tkzDrawPoints(O) % general style
  \tkzDrawPoints[mystyle,size=4](A) % my style
  \tkzLabelPoints(O,A)
\end{tikzpicture}
```

43. How to use arrows

In some countries, arrows are used to indicate the parallelism of lines, to represent half-lines or the sides of an angle (rays).

Here are some examples of how to place these arrows. `tkz-euclide` loads a library called `arrows.meta`.

```
\usetikzlibrary{arrows.meta}
```

This library is used to produce different styles of arrow heads. The next examples use some of them.

43.1. Arrows at endpoints on segment, ray or line

Stealth, Triangle, To, Latex and ...which can be combined with `reversed`. That's easy to place an arrow at one or two endpoints.

1. Triangle and Ray



```
\begin{tikzpicture}
  \tkzDefPoints{0/0/A,4/0/B}
  \tkzDrawSegment[-Triangle](A,B)
\end{tikzpicture}
```

2. Stealth and Segment



```
\begin{tikzpicture}
  \tkzDefPoints{0/0/A,4/0/B}
  \tkzDrawSegment[Stealth-Stealth](A,B)
\end{tikzpicture}
```

3. Latex and Line



```
\begin{tikzpicture}
  \tkzDefPoints{0/0/A,4/0/B}
  \tkzDrawLine[red,Latex-Latex](A,B)
  \tkzDrawPoints(A,B)
\end{tikzpicture}
```

4. To and Segment



```
\begin{tikzpicture}
  \tkzDefPoints{0/0/A,4/0/B}
  \tkzDrawSegment[To-To](A,B)
\end{tikzpicture}
```

5. Latex and Segment



```
\begin{tikzpicture}
  \tkzDefPoints{0/0/A,4/0/B}
  \tkzDrawSegment[Latex-Latex](A,B)
\end{tikzpicture}
```

6. Latex and Ray



```
\begin{tikzpicture}
  \tkzDefPoints{0/0/A,4/0/B}
  \tkzDrawSegment[Latex-](A,B)
\end{tikzpicture}
```

7. Latex and Several rays



```
\begin{tikzpicture}
  \tkzDefPoints{0/0/A,4/0/B,5/-2/C}
  \tkzDrawSegments[-Latex](A,B A,C)
\end{tikzpicture}
```

43.1.1. Scaling an arrow head



```
\begin{tikzpicture}
\tkzDefPoints{0/0/A,4/0/B}
\tkzDrawSegment[Latex[scale=2]](A,B)
\end{tikzpicture}
```

43.1.2. Using vector style

```
\tikzset{vector style/.style={>=Latex,->}}
```

You can redefine this style.



```
\begin{tikzpicture}
\tkzDefPoints{0/0/A,4/0/B}
\tkzDrawSegment[vector style](A,B)
\end{tikzpicture}
```

43.2. Arrows on middle point of a line segment

Arrows on lines are used to indicate that those lines are parallel. It depends on the country, in France we prefer to indicate outside the figure that $(A, B) \parallel (D, C)$. The code is an adaptation of an answer by [muzimuzhi](#) Z on the site tex.stackexchange.com.

Syntax:

- tkz arrow (Latex by default)
- tkz arrow=<arrow end tip>
- tkz arrow=<arrow end tip> at <pos> (<pos> = .5 by default)
- tkz arrow={<arrow end tip>[<arrow options>] at <pos>} option possible scale

Example usages:

```
\tkzDrawSegment[tkz arrow=Stealth] (A,B)
\tkzDrawSegment[tkz arrow={To[scale=3] at .4}](A,B)
\tkzDrawSegment[tkz arrow={Latex[scale=5,blue] at .6}](A,B)
```

43.2.1. In a parallelogram

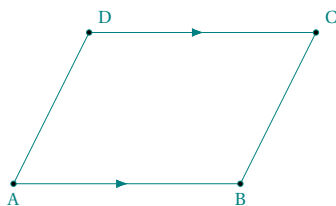

```
\begin{tikzpicture}
\tkzDefPoints{0/0/A,3/0/B,4/2/C}
\tkzDefParallelogram(A,B,C)
\tkzGetPoint{D}
\tkzDrawSegments[tkz arrow](A,B D,C)
\tkzDrawSegments(B,C D,A)
\tkzLabelPoints(A,B)
\tkzLabelPoints[above right](C,D)
\tkzDrawPoints(A,...,D)
\end{tikzpicture}
```

43.2.2. A line parallel to another one

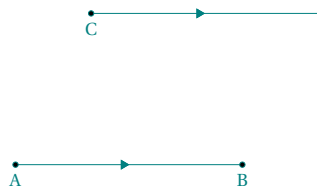

```
\begin{tikzpicture}
\tkzDefPoints{0/0/A,3/0/B,1/2/C}
\tkzDefPointWith[colinear= at C](A,B)
\tkzGetPoint{D}
\tkzDrawSegments[tkz arrow=Triangle](A,B C,D)
\tkzLabelPoints(A,B,C)
\tkzDrawPoints(A,...,C)
\end{tikzpicture}
```

43.2.3. Arrow on a circle

It is possible to place an arrow on the first quarter of a circle. A rotation allows you to move the arrow.

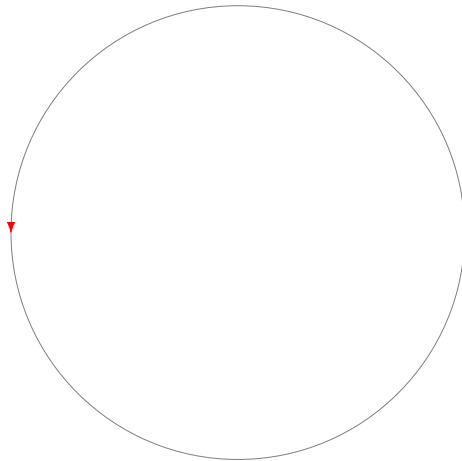

```
\begin{tikzpicture}
\tkzDefPoints{0/0/A,3/0/B}
\begin{scope}[rotate=150]
\tkzDrawCircle[tkz arrow={Latex[scale=2,red]}](A,B)
\end{scope}
\end{tikzpicture}
```

43.3. Arrows on all segments of a polygon

Some users of my package have asked me to be able to place an arrow on each side of a polygon. I used a style proposed by Paul Gaborit on the site tex.stackexchange.com.

```
\tikzset{tkz arrows/.style=
```

```
{postaction={on each path={tkz arrow={Latex[scale=2,color=black]}}}}
```

You can change this style. With `tkz arrows` you can an arrow on each segment of a polygon

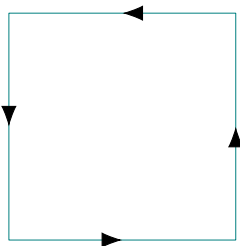
43.3.1. Arrow on each segment with `tkz arrows`

```
\begin{tikzpicture}
\tkzDefPoints{0/0/A,3/0/B}
\tkzDefSquare(A,B) \tkzGetPoints{C}{D}
\tkzDrawPolygon[tkz arrows](A,...,D)
\end{tikzpicture}
```

43.3.2. Using tkz arrows with a circle

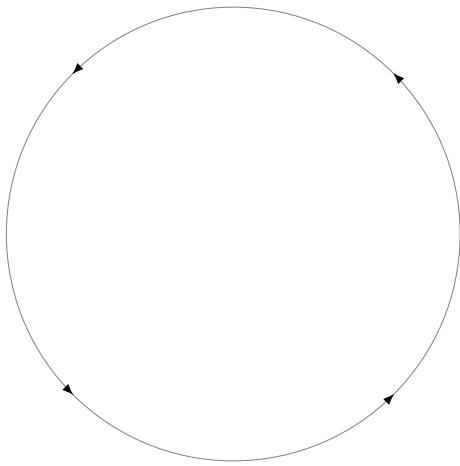

```
\begin{tikzpicture}
\tkzDefPoints{0/0/A,3/0/B}
\tkzDrawCircle[tkz arrows](A,B)
\end{tikzpicture}
```

Part IX.

Examples

44. Different authors

44.1. Code from Andrew Swan

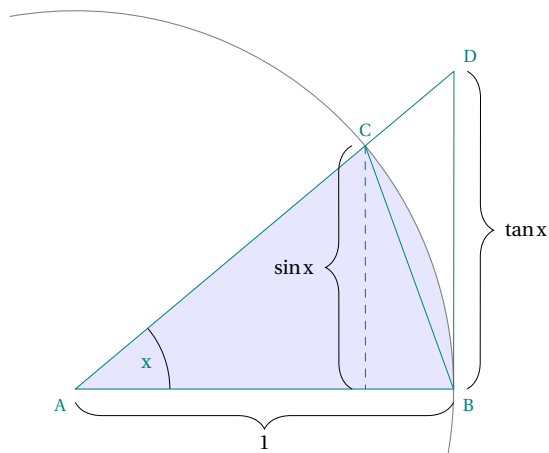

```

\begin{tikzpicture}[scale=1.25]
\def\radius{4}
\def\angle{40}
\pgfmathsetmacro{\htan}{tan(\angle)}
\tkzDefPoint(0,0){A} \tkzDefPoint(0,\radius){F}
\tkzDefPoint(\radius,0){B}
\tkzDefPointBy[rotation=center A angle \angle](B)
\tkzGetPoint{C}
\tkzDefLine[perpendicular=through B,K=1](A,B)
\tkzGetPoint{b}
\tkzInterLL(A,C)(B,b) \tkzGetPoint{D}
\tkzDefLine[perpendicular=through C,K=-1](A,B)
\tkzGetPoint{c}
\tkzInterLL(C,c)(A,B) \tkzGetPoint{E}
\tkzDrawSector[fill=blue,opacity=0.1](A,B)(C)
\tkzDrawArc[thin](A,B)(F)
\tkzMarkAngle(B,A,C)
\tkzLabelAngle[pos=0.8](B,A,C){x}
\tkzDrawPolygon(A,B,D)
\tkzDrawSegments(C,B)
\tkzDrawSegments[dashed,thin](C,E)
\tkzLabelPoints[below left](A)
\tkzLabelPoints[below right](B)
\tkzLabelPoints[above](C)
\tkzLabelPoints[above right](D)
\begin{scope}[pgf/decoration/raise=5pt]
\draw [decorate,decoration={brace,mirror,
amplitude=10pt},xshift=0pt,yshift=-4pt]
(A) -- (B) node [black,midway,yshift=-20pt]
{\footnotesize $1$};
\draw [decorate,decoration={brace,amplitude=10pt},
xshift=4pt,yshift=0pt]
(D) -- (B) node [black,midway,xshift=27pt]
{\footnotesize $\tan x$};
\draw [decorate,decoration={brace,amplitude=10pt},
xshift=4pt,yshift=0pt]
(E) -- (C) node [black,midway,xshift=-27pt]
{\footnotesize $\sin x$};
\end{scope}
\end{tikzpicture}

```

44.2. Example: Dimitris Kapeta

You need in this example to use `mkpos=.2` with `\tkzMarkAngle` because the measure of \widehat{CAM} is too small. Another possibility is to use `\tkzFillAngle`.

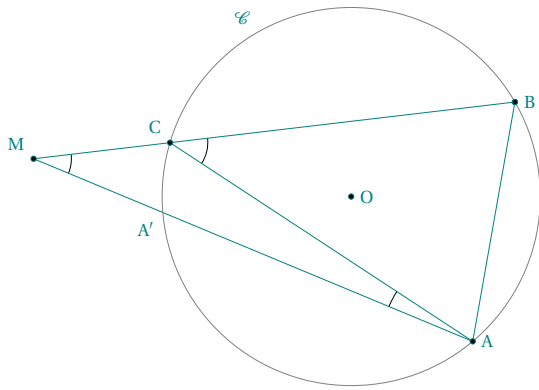

```

\begin{tikzpicture}[scale=1]
  \tkzDefPoint(0,0){O}
  \tkzDefPoint(2.5,0){N}
  \tkzDefPoint(-4.2,0.5){M}
  \tkzDefPointBy[rotation=center O angle 30](N)
  \tkzGetPoint{B}
  \tkzDefPointBy[rotation=center O angle -50](N)
  \tkzGetPoint{A}
  \tkzInterLC[common=B](M,B)(O,B) \tkzGetFirstPoint{C}
  \tkzInterLC[common=A](M,A)(O,A) \tkzGetFirstPoint{A'}
  \tkzMarkAngle[mkpos=.2, size=0.5](A,C,B)
  \tkzMarkAngle[mkpos=.2, size=0.5](A,M,C)
  \tkzDrawSegments(A,C M,A M,B A,B)
  \tkzDrawCircle(O,N)
  \tkzLabelCircle[above left](O,N)(120){%
    $\mathcal{C}$}
  \begin{scope}[xfp]
    \tkzMarkAngle[mkpos=.2, size=1.2](C,A,M)
  \end{scope}

  \tkzDrawPoints(O, A, B, M, B, C)
  \tkzLabelPoints[right](O,A,B)
  \tkzLabelPoints[above left](M,C)
  \tkzLabelPoint[below left](A'){$A'$}
\end{tikzpicture}

```

44.3. Example : John Kitzmiller

Prove that $\frac{AC}{CE} = \frac{BD}{DF}$.

Another interesting example from John, you can see how to use some extra options like `decoration` and `postaction` from TikZ with `tkz-euclide`.

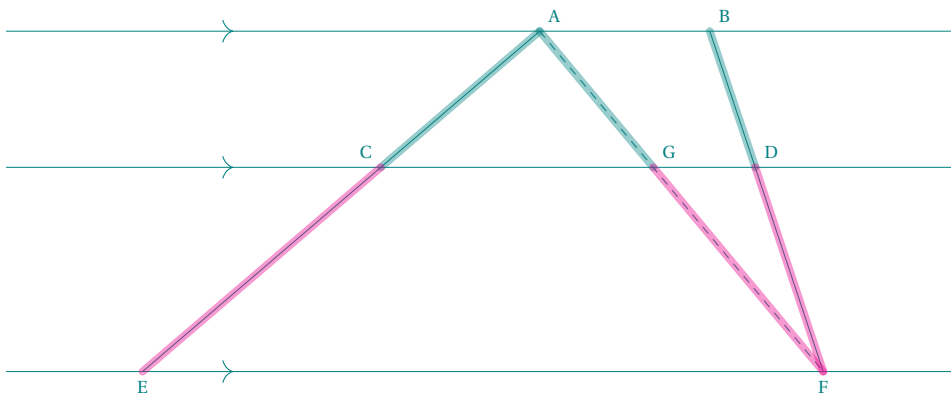

```

\begin{tikzpicture}[scale=1.5,decoration={markings,
mark=at position 3cm with {\arrow[scale=2]{>}}}
\tkzDefPoints{0/0/E, 6/0/F, 0/1.8/P, 6/1.8/Q, 0/3/R, 6/3/S}
\tkzDrawLines[postaction={decorate}](E,F P,Q R,S)
\tkzDefPoints{3.5/3/A, 5/3/B}
\tkzDrawSegments(E,A F,B)
\tkzInterLL(E,A)(P,Q) \tkzGetPoint{C}
\tkzInterLL(B,F)(P,Q) \tkzGetPoint{D}
\tkzLabelPoints[above right](A,B)
\tkzLabelPoints[below](E,F)
\tkzLabelPoints[above left](C)
\tkzDrawSegments[style=dashed](A,F)
\tkzInterLL(A,F)(P,Q) \tkzGetPoint{G}
\tkzLabelPoints[above right](D,G)
\tkzDrawSegments[color=teal, line width=3pt, opacity=0.4](A,C A,G)
\tkzDrawSegments[color=magenta, line width=3pt, opacity=0.4](C,E G,F)
\tkzDrawSegments[color=teal, line width=3pt, opacity=0.4](B,D)
\tkzDrawSegments[color=magenta, line width=3pt, opacity=0.4](D,F)
\end{tikzpicture}

```

44.4. Example 1: from Indonesia

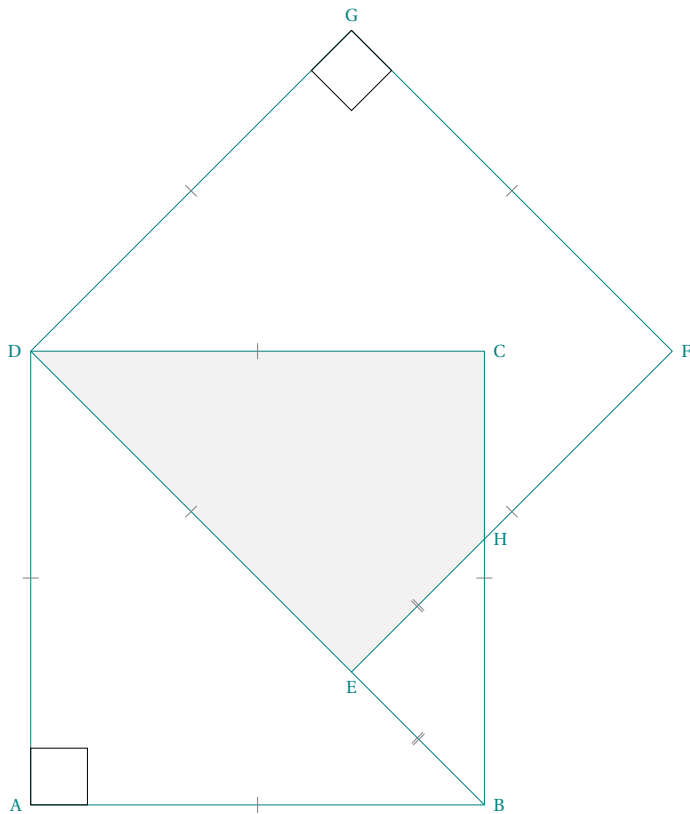

```

\begin{tikzpicture}[scale=3]
  \tkzDefPoints{0/0/A,2/0/B}
  \tkzDefSquare(A,B) \tkzGetPoints{C}{D}
  \tkzDefPointBy[rotation=center D angle 45](C)\tkzGetPoint{G}
  \tkzDefSquare(G,D)\tkzGetPoints{E}{F}
  \tkzInterLL(B,C)(E,F)\tkzGetPoint{H}
  \tkzFillPolygon[gray!10](D,E,H,C,D)
  \tkzDrawPolygon(A,...,D)\tkzDrawPolygon(D,...,G)
  \tkzDrawSegment(B,E)
  \tkzMarkSegments[mark=|,size=3pt,color=gray](A,B B,C C,D D,A E,F F,G G,D D,E)
  \tkzMarkSegments[mark=||,size=3pt,color=gray](B,E E,H)
  \tkzLabelPoints[left](A,D)
  \tkzLabelPoints[right](B,C,F,H)
  \tkzLabelPoints[above](G)\tkzLabelPoints[below](E)
  \tkzMarkRightAngles(D,A,B D,G,F)
\end{tikzpicture}

```

44.5. Example 2: from Indonesia

```

\begin{tikzpicture}[pol/.style={fill=brown!40,opacity=.2},
  seg/.style={tkzdotted,color=gray}, hidden pt/.style={fill=gray!40},
  mra/.style={color=gray!70,tkzdotted,/tkzrightangle/size=.2},scale=2]
  \tkzDefPoints{0/0/A,2.5/0/B,1.33/0.75/D,0/2.5/E,2.5/2.5/F}
  \tkzDefLine[parallel=through D](A,B) \tkzGetPoint{I1}
  \tkzDefLine[parallel=through B](A,D) \tkzGetPoint{I2}
  \tkzInterLL(D,I1)(B,I2) \tkzGetPoint{C}
  \tkzDefLine[parallel=through E](A,D) \tkzGetPoint{I3}
  \tkzDefLine[parallel=through D](A,E) \tkzGetPoint{I4}
  \tkzInterLL(E,I3)(D,I4) \tkzGetPoint{H}
  \tkzDefLine[parallel=through F](E,H) \tkzGetPoint{I5}
  \tkzDefLine[parallel=through H](E,F) \tkzGetPoint{I6}
  \tkzInterLL(F,I5)(H,I6) \tkzGetPoint{G}
  \tkzDefMidPoint(G,H) \tkzGetPoint{P} \tkzDefMidPoint(G,C) \tkzGetPoint{Q}
  \tkzDefMidPoint(B,C) \tkzGetPoint{R} \tkzDefMidPoint(A,B) \tkzGetPoint{S}
  \tkzDefMidPoint(A,E) \tkzGetPoint{T} \tkzDefMidPoint(E,H) \tkzGetPoint{U}
  \tkzDefMidPoint(A,D) \tkzGetPoint{M} \tkzDefMidPoint(D,C) \tkzGetPoint{N}
  \tkzInterLL(B,D)(S,R)\tkzGetPoint{L} \tkzInterLL(H,F)(U,P) \tkzGetPoint{K}
  \tkzDefLine[parallel=through K](D,H) \tkzGetPoint{I7}
  \tkzInterLL(K,I7)(B,D) \tkzGetPoint{O}
  \tkzFillPolygon[pol](P,Q,R,S,T,U)
  \tkzDrawSegments[seg](K,O K,L P,Q R,S T,U C,D H,D A,D M,N B,D)
  \tkzDrawSegments(E,H B,C G,F G,H G,C Q,R S,T U,P H,F)
  \tkzDrawPolygon(A,B,F,E)
  \tkzDrawPoints(A,B,C,E,F,G,H,P,Q,R,S,T,U,K) \tkzDrawPoints[hidden pt](M,N,O,D)
  \tkzMarkRightAngle[mra](L,O,K)
  \tkzMarkSegments[mark=|,size=1pt,thick,color=gray](A,S B,S B,R C,R
    Q,C Q,G G,P H,P E,U H,U E,T A,T)
  \tkzLabelAngle[pos=.3](K,L,O){\alpha}
  \tkzLabelPoints[below](O,A,S,B) \tkzLabelPoints[above](H,P,G)
  \tkzLabelPoints[left](T,E) \tkzLabelPoints[right](C,Q)
  \tkzLabelPoints[above left](U,D,M) \tkzLabelPoints[above right](L,N)
  \tkzLabelPoints[below right](F,R) \tkzLabelPoints[below left](K)
\end{tikzpicture}

```

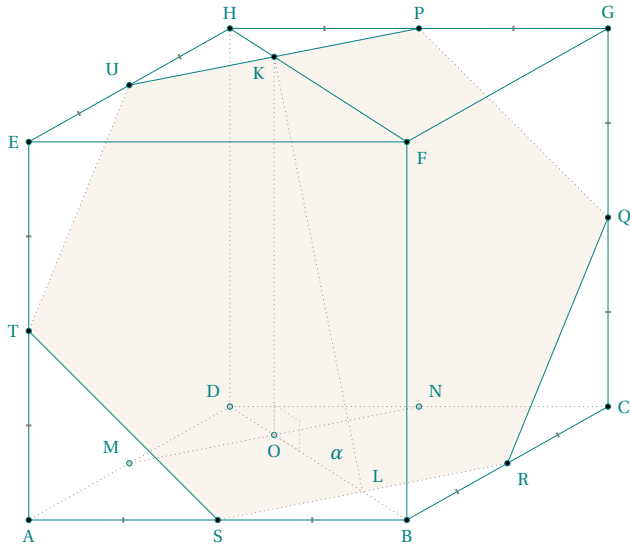

44.6. Illustration of the Morley theorem by Nicolas François

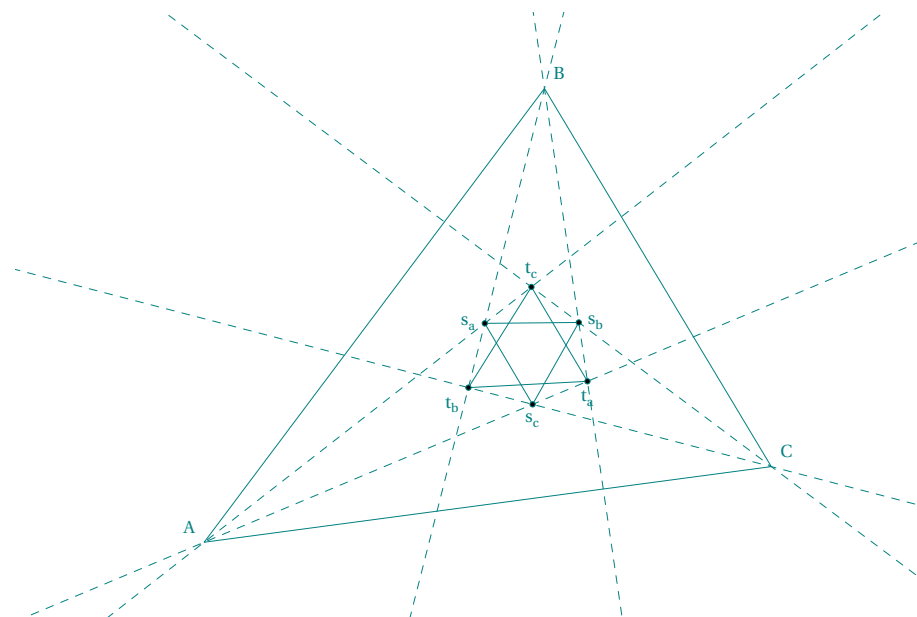

```

\begin{tikzpicture}
\tkzInit[ymin=-3,ymax=5,xmin=-5,xmax=7]
\tkzClip
\tkzDefPoints{-2.5/-2/A,2/4/B,5/-1/C}
\tkzFindAngle(C,A,B) \tkzGetAngle{anglea}
\tkzDefPointBy[rotation=center A angle 1*\anglea/3](C) \tkzGetPoint{TA1}
\tkzDefPointBy[rotation=center A angle 2*\anglea/3](C) \tkzGetPoint{TA2}
\tkzFindAngle(A,B,C) \tkzGetAngle{angleb}
\tkzDefPointBy[rotation=center B angle 1*\angleb/3](A) \tkzGetPoint{TB1}
\tkzDefPointBy[rotation=center B angle 2*\angleb/3](A) \tkzGetPoint{TB2}
\tkzFindAngle(B,C,A) \tkzGetAngle{anglec}
\tkzDefPointBy[rotation=center C angle 1*\anglec/3](B) \tkzGetPoint{TC1}
\tkzDefPointBy[rotation=center C angle 2*\anglec/3](B) \tkzGetPoint{TC2}
\tkzInterLL(A,TA1)(B,TB2) \tkzGetPoint{U1}
\tkzInterLL(A,TA2)(B,TB1) \tkzGetPoint{V1}
\tkzInterLL(B,TB1)(C,TC2) \tkzGetPoint{U2}
\tkzInterLL(B,TB2)(C,TC1) \tkzGetPoint{V2}
\tkzInterLL(C,TC1)(A,TA2) \tkzGetPoint{U3}
\tkzInterLL(C,TC2)(A,TA1) \tkzGetPoint{V3}
\tkzDrawPolygons(A,B,C U1,U2,U3 V1,V2,V3)
\tkzDrawLines[add=2 and 2,very thin,dashed](A,TA1 B,TB1 C,TC1 A,TA2 B,TB2 C,TC2)
\tkzDrawPoints(U1,U2,U3,V1,V2,V3)
\tkzLabelPoint[left](V1){$s_a$} \tkzLabelPoint[right](V2){$s_b$}
\tkzLabelPoint[below](V3){$s_c$} \tkzLabelPoint[above left](A){$A$}
\tkzLabelPoints[above right](B,C) \tkzLabelPoint(U1){$t_a$}
\tkzLabelPoint[below left](U2){$t_b$} \tkzLabelPoint[above](U3){$t_c$}
\end{tikzpicture}

```

44.7. Gou gu theorem / Pythagorean Theorem by Zhao Shuang

Gou gu theorem / Pythagorean Theorem by Zhao Shuang

Pythagoras was not the first person who discovered this theorem around the world. Ancient China discovered this theorem much earlier than him. So there is another name for the Pythagorean theorem in China, the Gou-Gu theorem. Zhao Shuang was an ancient Chinese mathematician. He rediscovered the “Gou gu theorem”, which is actually the Chinese version of the “Pythagorean theorem”. Zhao Shuang used a method called the “cutting and compensation principle”, he created a picture of “Pythagorean Round Square” Below the figure used to illustrate the proof of the “Gou gu theorem.” (code from Nan Geng)

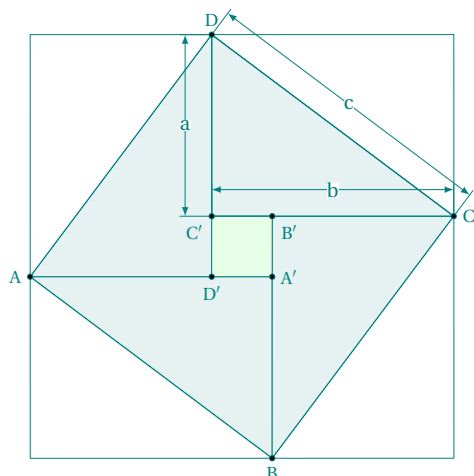

```
\begin{tikzpicture}[scale=.8]
  \tkzDefPoint(0,0){A} \tkzDefPoint(4,0){A'}
  \tkzInterCC[R](A, 5)(A', 3)
  \tkzGetSecondPoint{B}
  \tkzDefSquare(A,B) \tkzGetPoints{C}{D}
  \tkzCalcLength(A,A') \tkzGetLength{lA}
  \tkzCalcLength(A',B) \tkzGetLength{lB}
  \pgfmathparse{\lA-\lB}
  \tkzInterLC[R](A,A')(A',\pgfmathresult)
  \tkzGetFirstPoint{D'}
  \tkzDefSquare(D',A')\tkzGetPoints{B'}{C'}
  \tkzDefLine[orthogonal=through D](D,D')
  \tkzGetPoint{d}
  \tkzDefLine[orthogonal=through A](A,A')
  \tkzGetPoint{a}
  \tkzDefLine[orthogonal=through C](C,C')
  \tkzGetPoint{c}
  \tkzInterLL(D,d)(C,c) \tkzGetPoint{E}
  \tkzInterLL(D,d)(A,a) \tkzGetPoint{F}
  \tkzDefSquare(E,F)\tkzGetPoints{G}{H}
  \tkzDrawPolygons[fill=teal!10](A,B,A' B,C,B'
    C,D,C' A,D',D)
  \tkzDrawPolygons(A,B,C,D E,F,G,H)
  \tkzDrawPolygon[fill=green!10](A',B',C',D')
  \tkzDrawSegment[dim={\$a$, -10pt,}] (D,C')
  \tkzDrawSegment[dim={\$b$, -10pt,}] (C,C')
  \tkzDrawSegment[dim={\$c$, -10pt,}] (C,D)
  \tkzDrawPoints[size=2](A,B,C,D,A',B',C',D')
  \tkzLabelPoints[left](A)
  \tkzLabelPoints[below](B)
  \tkzLabelPoints[right](C)
  \tkzLabelPoints[above](D)
  \tkzLabelPoints[right](A')
  \tkzLabelPoints[below right](B')
  \tkzLabelPoints[below left](C')
  \tkzLabelPoints[below](D')
\end{tikzpicture}
```

44.8. Reuleaux-Triangle

Reuleaux-triangle by Stefan Kottwitz

A well-known classic field of mathematics is geometry. You may know Euclidean geometry from school, with constructions by compass and ruler. Math teachers may be very interested in drawing geometry constructions and explanations. Underlying constructions can help us with general drawings where we would need intersections and tangents of lines and circles, even if it does not look like geometry. So, here, we will remember school geometry drawings. We will use the `tkz-euclide` package, which works on top of TikZ. We will construct an equilateral triangle. Then we extend it to get a Reuleaux triangle, and add annotations. The code is fully explained in the *LaTeX Cookbook*, Chapter 10, *Advanced Mathematics*, *Drawing geometry pictures*. Stefan Kottwitz

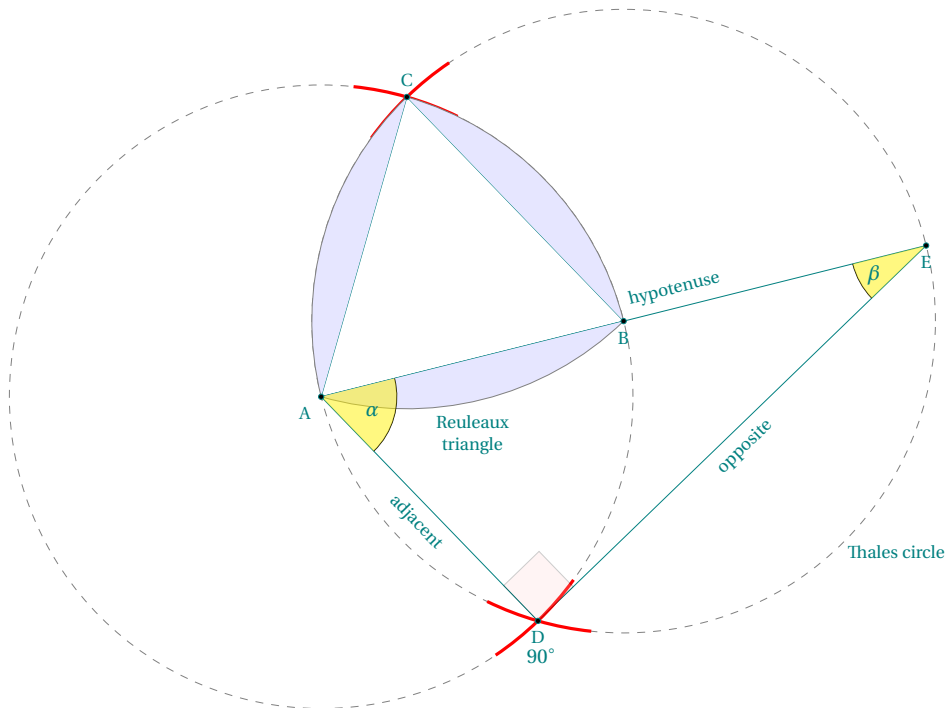

```

\begin{tikzpicture}
  \tkzDefPoint(0,0){A} \tkzDefPoint(4,1){B}
  \tkzInterCC(A,B)(B,A) \tkzGetPoints{C}{D}
  \tkzInterLC(A,B)(B,A) \tkzGetPoints{F}{E}
  \tkzDrawCircles[dashed](A,B B,A)
  \tkzDrawPolygons(A,B,C A,E,D)
  \tkzCompass[color=red, very thick](A,C B,C A,D B,D)
  \begin{scope}
    \tkzSetUpArc[thick,delta=0]
    \tkzDrawArc[fill=blue!10](A,B)(C)
    \tkzDrawArc[fill=blue!10](B,C)(A)
    \tkzDrawArc[fill=blue!10](C,A)(B)
  \end{scope}
  \tkzMarkAngles(D,A,E A,E,D)
  \tkzFillAngles[fill=yellow,opacity=0.5](D,A,E A,E,D)
  \tkzMarkRightAngle[size=0.65,fill=red!20,opacity=0.2](A,D,E)
  \tkzLabelAngle[pos=0.7](D,A,E){$\alpha$}
  \tkzLabelAngle[pos=0.8](A,E,D){$\beta$}
  \tkzLabelAngle[pos=0.5,xshift=-1.4mm](A,D,D){$90^\circ$}
  \begin{scope}[font=\small]
    \tkzLabelSegment[below=0.6cm,align=center](A,B){Reuleaux\triangle}
    \tkzLabelSegment[above right,sloped](A,E){hypotenuse}
    \tkzLabelSegment[below,sloped](D,E){opposite}
    \tkzLabelSegment[below,sloped](A,D){adjacent}
    \tkzLabelSegment[below right=4cm](A,E){Thales circle}
  \end{scope}
  \tkzLabelPoints[below left](A)
  \tkzLabelPoints(B,D)
  \tkzLabelPoint[above](C){$C$}
  \tkzLabelPoints(E)
  \tkzDrawPoints(A,...,E)
\end{tikzpicture}

```

45. Some interesting examples

45.1. Square root of the integers

Square root of the integers

How to get $1, \sqrt{2}, \sqrt{3}$ with a rule and a compass.

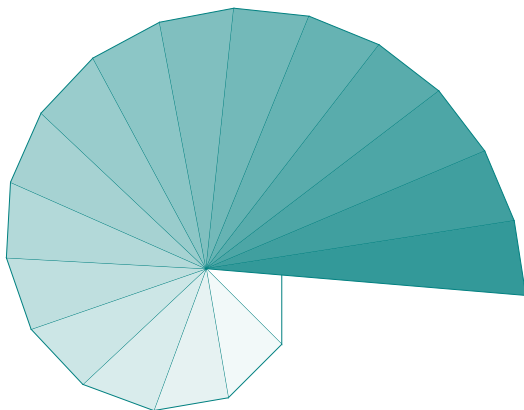

```

\begin{tikzpicture}
  \tkzDefPoint(0,0){0}
  \tkzDefPoint(1,0){a0}
  \tkzDrawSegment(0,a0)
  \foreach \i [count=\j] in {0,...,16}{%
    \tkzDefPointWith[orthogonal normed](a\i,0)
    \tkzGetPoint{a\j}
    \pgfmathsetmacro{\c}{5*\i}
    \tkzDrawPolySeg[fill=teal!\c](a\i,a\j,0)
  }
\end{tikzpicture}

```

45.2. About right triangle

About right triangle

We have a segment $[AB]$ and we want to determine a point C such that $AC = 8$ cm and ABC is a right triangle in B .

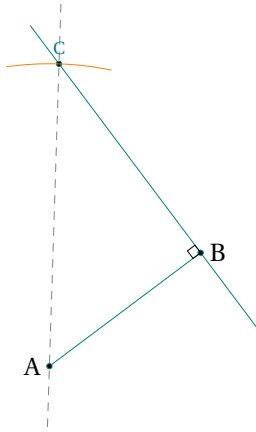

```
\begin{tikzpicture}[scale=.5]
  \tkzDefPoint["$A$" left](2,1){A}
  \tkzDefPoint["$B$" right](6,4){B}
  \tkzDefPointWith[orthogonal,K=-1](B,A)
  \tkzDrawLine[add = .5 and .5](B,t kzPointResult)
  \tkzInterLC[R](B,t kzPointResult)(A,8)
  \tkzGetPoints{J}{C}
  \tkzDrawSegment(A,B)
  \tkzDrawPoints(A,B,C)
  \tkzCompass(A,C)
  \tkzMarkRightAngle(A,B,C)
  \tkzDrawLine[color=gray,style=dashed](A,C)
  \tkzLabelPoint[above](C){C$}
\end{tikzpicture}
```

45.3. Archimedes

Archimedes

This is an ancient problem proved by the great Greek mathematician Archimedes . The figure below shows a semicircle, with diameter AB . A tangent line is drawn and touches the semicircle at B . Another tangent line at a point, C , on the semicircle is drawn. We project the point C on the line segment $[AB]$ on a point D . The two tangent lines intersect at the point T . Prove that the line (AT) bisects (CD)

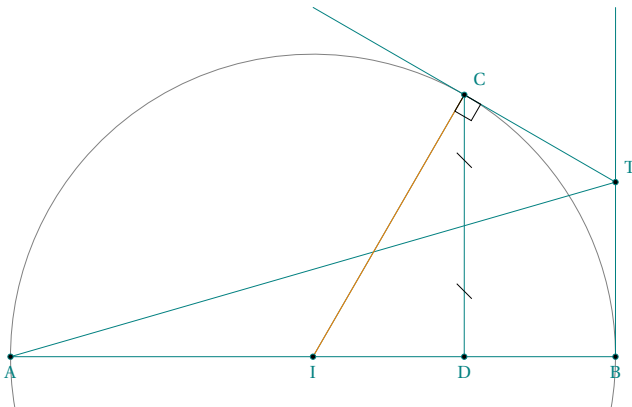

```

\begin{tikzpicture}[scale=1]
  \tkzDefPoint(0,0){A}\tkzDefPoint(6,0){D}
  \tkzDefPoint(8,0){B}\tkzDefPoint(4,0){I}
  \tkzDefLine[orthogonal=through D](A,D)
  \tkzInterLC[R](D,\tkzPointResult)(I,4)\tkzGetSecondPoint{C}
  \tkzDefLine[orthogonal=through C](I,C)\tkzGetPoint{c}
  \tkzDefLine[orthogonal=through B](A,B)\tkzGetPoint{b}
  \tkzInterLL(C,c)(B,b)\tkzGetPoint{T}
  \tkzInterLL(A,T)(C,D)\tkzGetPoint{P}
  \tkzDrawArc(I,B)(A)
  \tkzDrawSegments(A,B A,T C,D I,C)\tkzDrawSegment[new](I,C)
  \tkzDrawLine[add = 1 and 0](C,T)\tkzDrawLine[add = 0 and 1](B,T)
  \tkzMarkRightAngle(I,C,T)
  \tkzDrawPoints(A,B,I,D,C,T)
  \tkzLabelPoints(A,B,I,D)\tkzLabelPoints[above right](C,T)
  \tkzMarkSegment[pos=.25,mark=s|](C,D)\tkzMarkSegment[pos=.75,mark=s|](C,D)
\end{tikzpicture}

```

45.3.2. Steiner Line and Simson Line

Steiner Line and Simson Line

Consider the triangle ABC and a point M on its circumcircle. The projections of M on the sides of the triangle are on a line (Steiner Line), The three closest points to M on lines AB , AC , and BC are collinear. It's the Simson Line.

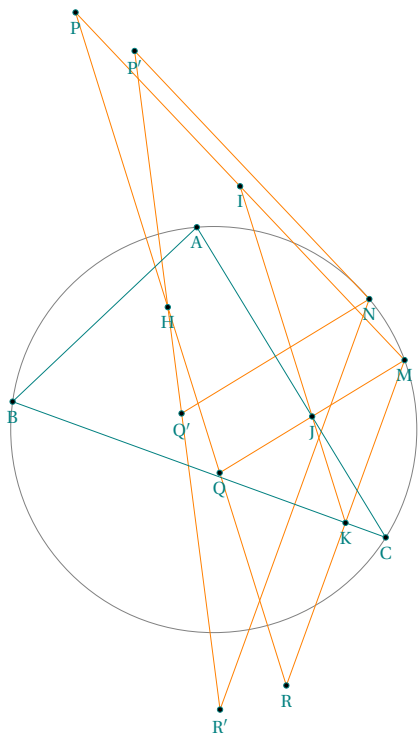

```
\begin{tikzpicture}[scale=.75,rotate=-20]
  \tkzDefPoint(0,0){B}
  \tkzDefPoint(2,4){A} \tkzDefPoint(7,0){C}
  \tkzDefCircle[circum](A,B,C)
  \tkzGetPoint{O}
  \tkzDrawCircle(O,A)
  \tkzCalcLength(O,A)
  \tkzGetLength{rOA}
  \tkzDefShiftPoint[O](40:\rOA){M}
  \tkzDefShiftPoint[O](60:\rOA){N}
  \tkzDefTriangleCenter[orthic](A,B,C)
  \tkzGetPoint{H}
  \tkzDefSpcTriangle[orthic,name=H](A,B,C){a,b,c}
  \tkzDefPointsBy[reflection=over A--B](M,N){P,P'}
  \tkzDefPointsBy[reflection=over A--C](M,N){Q,Q'}
  \tkzDefPointsBy[reflection=over C--B](M,N){R,R'}
  \tkzDefMidPoint(M,P)\tkzGetPoint{I}
  \tkzDefMidPoint(M,Q)\tkzGetPoint{J}
  \tkzDefMidPoint(M,R)\tkzGetPoint{K}
  \tkzDrawSegments[new](P,R M,P M,Q M,R N,P'%
    N,Q' N,R' P',R' I,K)
  \tkzDrawPolygons(A,B,C)
  \tkzDrawPoints(A,B,C,H,M,N,P,Q,R,P',Q',R',I,J,K)
  \tkzLabelPoints(A,B,C,H,M,N,P,Q,R,P',Q',R',I,J,K)
\end{tikzpicture}
```

45.4. Lune of Hippocrates

Lune of Hippocrates

From wikipedia : In geometry, the lune of Hippocrates, named after Hippocrates of Chios, is a lune bounded by arcs of two circles, the smaller of which has as its diameter a chord spanning a right angle on the larger circle. In the first figure, the area of the lune is equal to the area of the triangle ABC. Hippocrates of Chios (ancient Greek mathematician,)

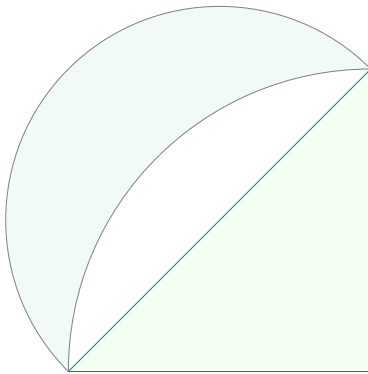

```
\begin{tikzpicture}
\tkzInit[xmin=-2,xmax=5,ymin=-1,ymax=6]
\tkzClip % allows you to define a bounding box
% large enough
\tkzDefPoint(0,0){A}\tkzDefPoint(4,0){B}
\tkzDefSquare(A,B)
\tkzGetFirstPoint{C}
\tkzDrawPolygon[fill=green!5](A,B,C)
\begin{scope}
\tkzClipCircle[out](B,A)
\tkzDefMidPoint(C,A)\tkzGetPoint{M}
\tkzDrawSemiCircle[fill=teal!5](M,C)
\end{scope}
\tkzDrawArc[delta=90](B,C)(A)
\end{tikzpicture}
```

45.5. Lunes of Hasan Ibn al-Haytham

Lune of Hippocrates

From wikipedia : the Arab mathematician Hasan Ibn al-Haytham (Latinized name Alhazen) showed that two lunes, formed on the two sides of a right triangle, whose outer boundaries are semicircles and whose inner boundaries are formed by the circumcircle of the triangle, then the areas of these two lunes added together are equal to the area of the triangle. The lunes formed in this way from a right triangle are known as the lunes of Alhazen.

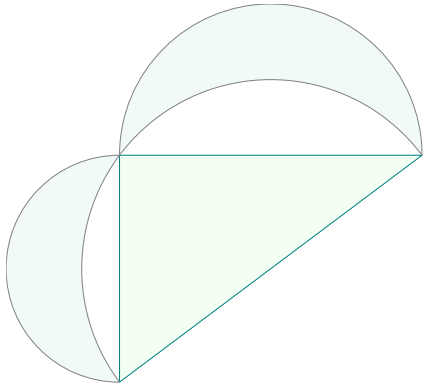

```

\begin{tikzpicture}[scale=.5,rotate=180]
  \tkzInit[xmin=-1,xmax=11,ymin=-4,ymax=7]
  \tkzClip
  \tkzDefPoints{0/0/A,8/0/B}
  \tkzDefTriangle[pythagore,swap](A,B)
  \tkzGetPoint{C}
  \tkzDrawPolygon[fill=green!5](A,B,C)
  \tkzDefMidPoint(C,A) \tkzGetPoint{I}
  \begin{scope}
    \tkzClipCircle[out](I,A)
    \tkzDefMidPoint(B,A) \tkzGetPoint{x}
    \tkzDrawSemiCircle[fill=teal!5](x,A)
    \tkzDefMidPoint(B,C) \tkzGetPoint{y}
    \tkzDrawSemiCircle[fill=teal!5](y,B)
  \end{scope}
  \tkzSetUpCompass[/tkzcompass/delta=0]
  \tkzDefMidPoint(C,A) \tkzGetPoint{z}
  \tkzDrawSemiCircle(z,A)
\end{tikzpicture}

```

45.6. About clipping circles

About clipping circles

The problem is the management of the bounding box. First you have to define a rectangle in which the figure will be inserted. This is done with the first two lines.

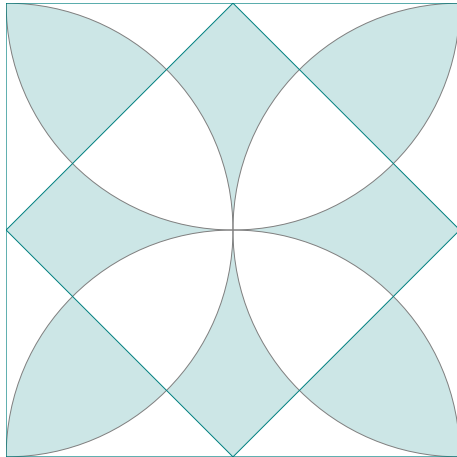

```

\begin{tikzpicture}
  \tkzInit[xmin=0,xmax=6,ymin=0,ymax=6]
  \tkzClip
  \tkzDefPoints{0/0/A, 6/0/B}
  \tkzDefSquare(A,B)      \tkzGetPoints{C}{D}
  \tkzDefMidPoint(A,B)    \tkzGetPoint{M}
  \tkzDefMidPoint(A,D)    \tkzGetPoint{N}
  \tkzDefMidPoint(B,C)    \tkzGetPoint{O}
  \tkzDefMidPoint(C,D)    \tkzGetPoint{P}
  \begin{scope}
    \tkzClipCircle[out](M,B) \tkzClipCircle[out](P,D)
    \tkzFillPolygon[teal!20](M,N,P,O)
  \end{scope}
  \begin{scope}
    \tkzClipCircle[out](N,A) \tkzClipCircle[out](O,C)
    \tkzFillPolygon[teal!20](M,N,P,O)
  \end{scope}
  \begin{scope}
    \tkzClipCircle(P,C) \tkzClipCircle(N,A)
    \tkzFillPolygon[teal!20](N,P,D)
  \end{scope}
  \begin{scope}
    \tkzClipCircle(O,C) \tkzClipCircle(P,C)
    \tkzFillPolygon[teal!20](P,C,O)
  \end{scope}
  \begin{scope}
    \tkzClipCircle(M,B) \tkzClipCircle(O,B)
    \tkzFillPolygon[teal!20](O,B,M)
  \end{scope}
  \begin{scope}
    \tkzClipCircle(N,A) \tkzClipCircle(M,A)
    \tkzFillPolygon[teal!20](A,M,N)
  \end{scope}
  \tkzDrawSemiCircles(M,B N,A O,C P,D)
  \tkzDrawPolygons(A,B,C,D M,N,P,O)
\end{tikzpicture}

```

45.7. Similar isosceles triangles

Similar isosceles triangles

The following is from the excellent site **Descartes et les Mathématiques**. I did not modify the text and I am only the author of the programming of the figures. <http://debart.pagesperso-orange.fr/seconde/triangle.html>

The following is from the excellent site **Descartes et les Mathématiques**. I did not modify the text and I am only the author of the programming of the figures.

<http://debart.pagesperso-orange.fr/seconde/triangle.html>

Bibliography:

- Géométrie au Bac - Tangente, special issue no. 8 - Exercice 11, page 11
- Elisabeth Busser and Gilles Cohen: 200 nouveaux problèmes du "Monde" - POLE 2007 (200 new problems of "Le Monde")
- Affaire de logique n° 364 - Le Monde February 17, 2004

Two statements were proposed, one by the magazine *Tangente* and the other by *Le Monde*.

Editor of the magazine "Tangente": Two similar isosceles triangles AXB and BYC are constructed with main vertices X and Y, such that A, B and C are aligned and that these triangles are "indirect". Let α be the angle at vertex $\widehat{AXB} = \widehat{BYC}$. We then construct a third isosceles triangle XZY similar to the first two, with main vertex Z and "indirect". We ask to demonstrate that point Z belongs to the straight line (AC).

Editor of "Le Monde": We construct two similar isosceles triangles AXB and BYC with principal vertices X and Y, such that A, B and C are aligned and that these triangles are "indirect". Let α be the angle at vertex $\widehat{AXB} = \widehat{BYC}$. The point Z of the line segment [AC] is equidistant from the two vertices X and Y. At what angle does he see these two vertices?

The constructions and their associated codes are on the next two pages, but you can search before looking. The programming respects (it seems to me ...) my reasoning in both cases.

45.9. "Le Monde" version

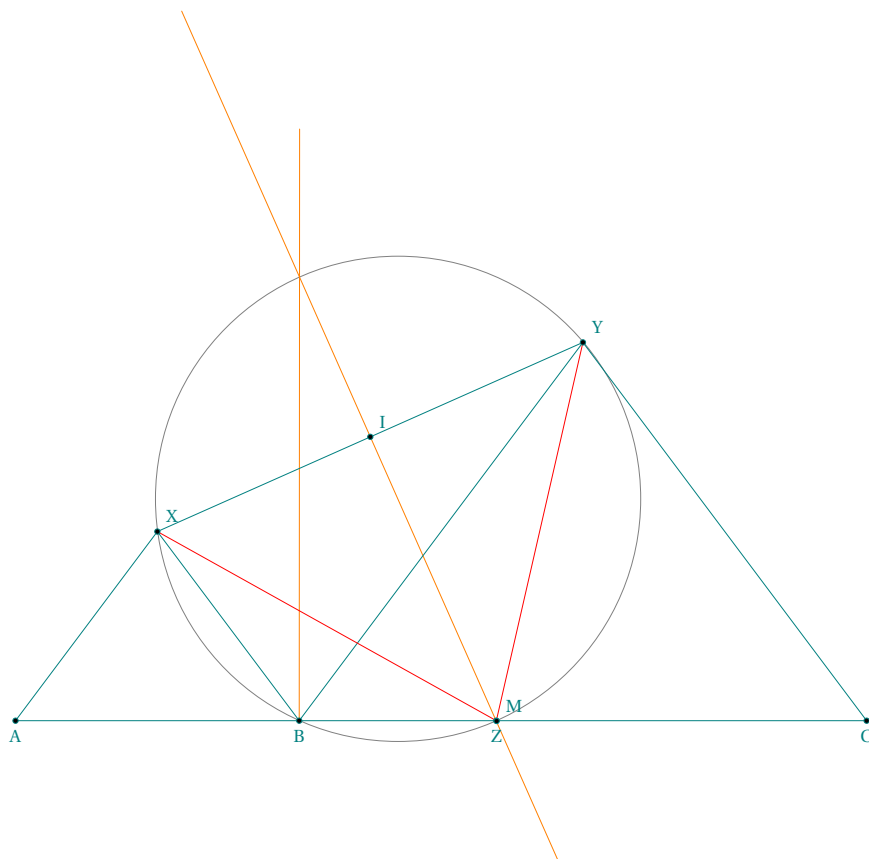

```

\begin{tikzpicture}[scale=1.25]
  \tkzDefPoint(0,0){A}
  \tkzDefPoint(3,0){B}
  \tkzDefPoint(9,0){C}
  \tkzDefPoint(1.5,2){X}
  \tkzDefPoint(6,4){Y}
  \tkzDefCircle[circum](X,Y,B) \tkzGetPoint{O}
  \tkzDefMidPoint(X,Y) \tkzGetPoint{I}
  \tkzDefPointWith[orthogonal](I,Y) \tkzGetPoint{i}
  \tkzDrawLines[add = 2 and 1,color=orange](I,i)
  \tkzInterLL(I,i)(A,B) \tkzGetPoint{Z}
  \tkzInterLC(I,i)(O,B) \tkzGetFirstPoint{M}
  \tkzDefPointWith[orthogonal](B,Z) \tkzGetPoint{b}
  \tkzDrawCircle(O,B)
  \tkzDrawLines[add = 0 and 2,color=orange](B,b)
  \tkzDrawSegments(A,X B,X B,Y C,Y A,C X,Y)
  \tkzDrawSegments[color=red](X,Z Y,Z)
  \tkzDrawPoints(A,B,C,X,Y,Z,M,I)
  \tkzLabelPoints(A,B,C,Z)
  \tkzLabelPoints[above right](X,Y,M,I)
\end{tikzpicture}

```

45.10. Triangle altitudes

Triangle altitudes

From Wikipedia : The following is again from the excellent site *Descartes et les Mathématiques* (Descartes and the Mathematics). http://debart.pagesperso-orange.fr/geoplan/geometrie_triangle.html. The three altitudes of a triangle intersect at the same H-point.

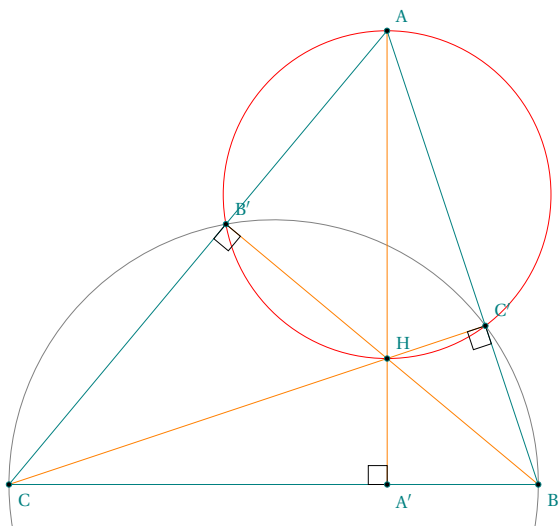

```

\begin{tikzpicture}
  \tkzDefPoint(0,0){C} \tkzDefPoint(7,0){B}
  \tkzDefPoint(5,6){A}
  \tkzDefMidPoint(C,B) \tkzGetPoint{I}
  \tkzInterLC(A,C)(I,B)
  \tkzGetFirstPoint{B'}
  \tkzInterLC(A,B)(I,B)
  \tkzGetSecondPoint{C'}
  \tkzInterLL(B,B')(C,C') \tkzGetPoint{H}
  \tkzInterLL(A,H)(C,B) \tkzGetPoint{A'}
  \tkzDefCircle[circum](A,B',C') \tkzGetPoint{O}
  \tkzDrawArc(I,B)(C)
  \tkzDrawPolygon(A,B,C)
  \tkzDrawCircle[color=red](O,A)
  \tkzDrawSegments[color=orange](B,B' C,C' A,A')
  \tkzMarkRightAngles(C,B',B B,C',C C,A',A)
  \tkzDrawPoints(A,B,C,A',B',C',H)
  \tkzLabelPoints[above right](A,B',C',H)
  \tkzLabelPoints[below right](B,C,A')
\end{tikzpicture}

```

45.11. Altitudes - other construction

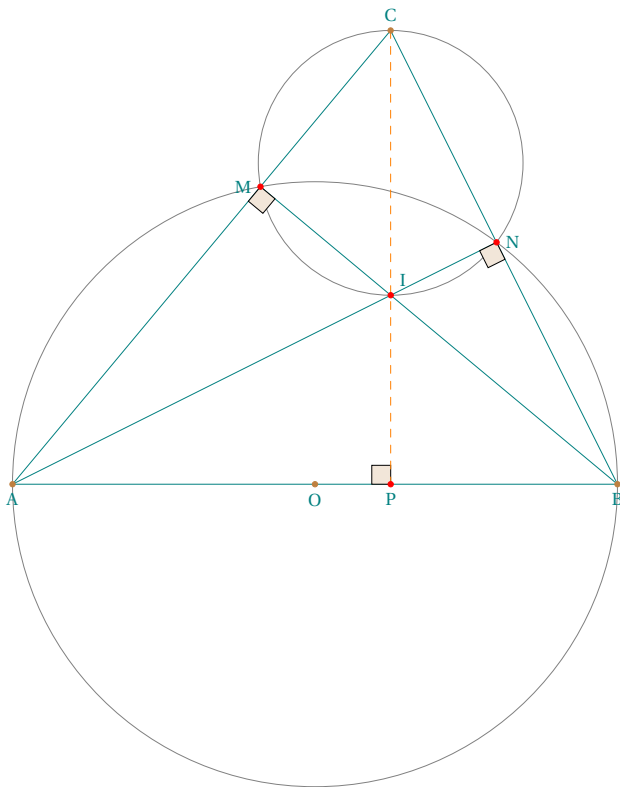

```

\begin{tikzpicture}
\tkzDefPoint(0,0){A} \tkzDefPoint(8,0){B}
\tkzDefPoint(5,6){C}
\tkzDefMidPoint(A,B)\tkzGetPoint{O}
\tkzDefPointBy[projection=onto A--B](C) \tkzGetPoint{P}
\tkzInterLC[common=A](C,A)(O,A)
\tkzGetFirstPoint{M}
\tkzInterLC(C,B)(O,A)
\tkzGetSecondPoint{N}
\tkzInterLL(B,M)(A,N)\tkzGetPoint{I}
\tkzDefCircle[diameter](A,B)\tkzGetPoint{x}
\tkzDefCircle[diameter](I,C)\tkzGetPoint{y}
\tkzDrawCircles(x,y,C)
\tkzDrawSegments(C,A C,B A,B B,M A,N)
\tkzMarkRightAngles[fill=brown!20](A,M,B A,N,B A,P,C)
\tkzDrawSegment[style=dashed,color=orange](C,P)
\tkzLabelPoints(O,A,B,P)
\tkzLabelPoint[left](M){M}
\tkzLabelPoint[right](N){N}
\tkzLabelPoint[above](C){C}
\tkzLabelPoint[above right](I){I}
\tkzDrawPoints[color=red](M,N,P,I)
\tkzDrawPoints[color=brown](O,A,B,C)
\end{tikzpicture}

```

45.12. Three circles in an Equilateral Triangle

Three circles in an Equilateral Triangle

From Wikipedia: In geometry, the Malfatti circles are three circles inside a given triangle such that each circle is tangent to the other two and to two sides of the triangle. They are named after Gian Francesco Malfatti, who made early studies of the problem of constructing these circles in the mistaken belief that they would have the largest possible total area of any three disjoint circles within the triangle. Below is a study of a particular case with an equilateral triangle and three identical circles.

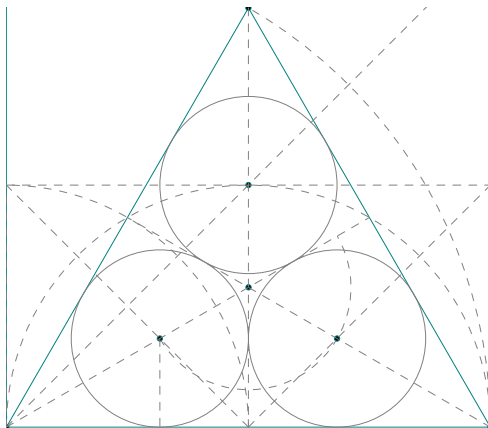

```

\begin{tikzpicture}[scale=.8]
  \tkzDefPoints{0/0/A,8/0/B,0/4/a,8/4/b,8/8/c}
  \tkzDefTriangle[equilateral](A,B) \tkzGetPoint{C}
  \tkzDefMidPoint(A,B) \tkzGetPoint{M}
  \tkzDefMidPoint(B,C) \tkzGetPoint{N}
  \tkzDefMidPoint(A,C) \tkzGetPoint{P}
  \tkzInterLL(A,N)(M,a) \tkzGetPoint{Ia}
  \tkzDefPointBy[projection = onto A--B](Ia)
  \tkzGetPoint{ha}
  \tkzInterLL(B,P)(M,b) \tkzGetPoint{Ib}
  \tkzDefPointBy[projection = onto A--B](Ib)
  \tkzGetPoint{hb}
  \tkzInterLL(A,c)(M,C) \tkzGetPoint{Ic}
  \tkzDefPointBy[projection = onto A--C](Ic)
  \tkzGetPoint{hc}
  \tkzInterLL(A,Ia)(B,Ib) \tkzGetPoint{G}
  \tkzDefSquare(A,B) \tkzGetPoints{D}{E}
  \tkzDrawPolygon(A,B,C)
  \tkzClipBB
  \tkzDrawSemiCircles[gray,dashed](M,B A,M
  A,B B,A G,Ia)
  \tkzDrawCircles[gray](Ia,ha Ib,hb Ic,hc)
  \tkzDrawPolySeg(A,E,D,B)
  \tkzDrawPoints(A,B,C,G,Ia,Ib,Ic)
  \tkzDrawSegments[gray,dashed](C,M A,N B,P
  M,a M,b A,a a,b b,B A,D Ia,ha)
\end{tikzpicture}

```

45.13. Law of sines

Law of sines

From wikipedia : *In trigonometry, the law of sines, sine law, sine formula, or sine rule is an equation relating the lengths of the sides of a triangle (any shape) to the sines of its angles.*

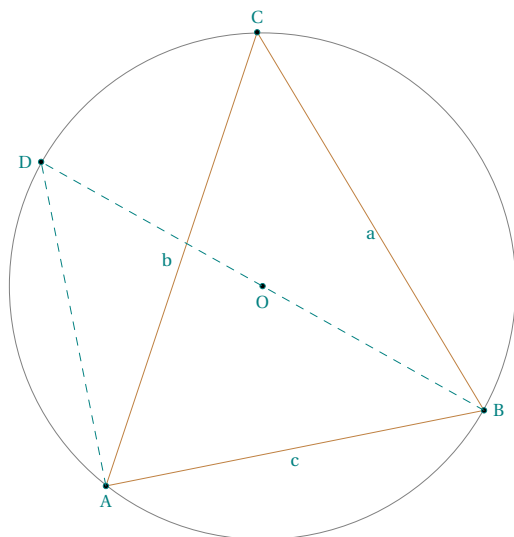

```

\begin{tikzpicture}
\tkzDefPoints{O/Q/A,5/1/B,2/6/C}
\tkzDefTriangleCenter[circum](A,B,C)
\tkzGetPoint{O}
\tkzDefPointBy[symmetry=center O](B)
\tkzGetPoint{D}
\tkzDrawPolygon[color=brown](A,B,C)
\tkzDrawCircle(O,A)
\tkzDrawPoints(A,B,C,D,O)
\tkzDrawSegments[dashed](B,D A,D)
\tkzLabelPoint[left](D){D}
\tkzLabelPoint[below](A){A}
\tkzLabelPoint[above](C){C}
\tkzLabelPoint[right](B){B}
\tkzLabelPoint[below](O){O}
\tkzLabelSegment(B,C){a}
\tkzLabelSegment[left](A,C){b}
\tkzLabelSegment(A,B){c}
\end{tikzpicture}

```

In the triangle ABC

$$\frac{a}{\sin A} = \frac{b}{\sin B} = \frac{c}{\sin C} \quad (1)$$

$$\hat{C} = \hat{D}$$

$$\frac{c}{2R} = \sin D = \sin C \quad (2)$$

Then

$$\frac{c}{\sin C} = 2R$$

45.14. Flower of Life

Book IV, proposition XI _Euclid's Elements_

Sacred geometry can be described as a belief system attributing a religious or cultural value to many of the fundamental forms of space and time. According to this belief system, the basic patterns of existence are perceived as sacred because in contemplating them one is contemplating the origin of all things. By studying the nature of these forms and their relationship to each other, one may seek to gain insight into the scientific, philosophical, psychological, aesthetic and mystical laws of the universe. The Flower of Life is considered to be a symbol of sacred geometry, said to contain ancient, religious value depicting the fundamental forms of space and time. In this sense, it is a visual expression of the connections life weaves through all mankind, believed by some to contain a type of Akashic Record of basic information of all living things.

One of the beautiful arrangements of circles found at the Temple of Osiris at Abydos, Egypt (Rawles 1997).
Weisstein, Eric W. "Flower of Life." From MathWorld—A Wolfram Web Resource.

<http://mathworld.wolfram.com/FlowerofLife.html>

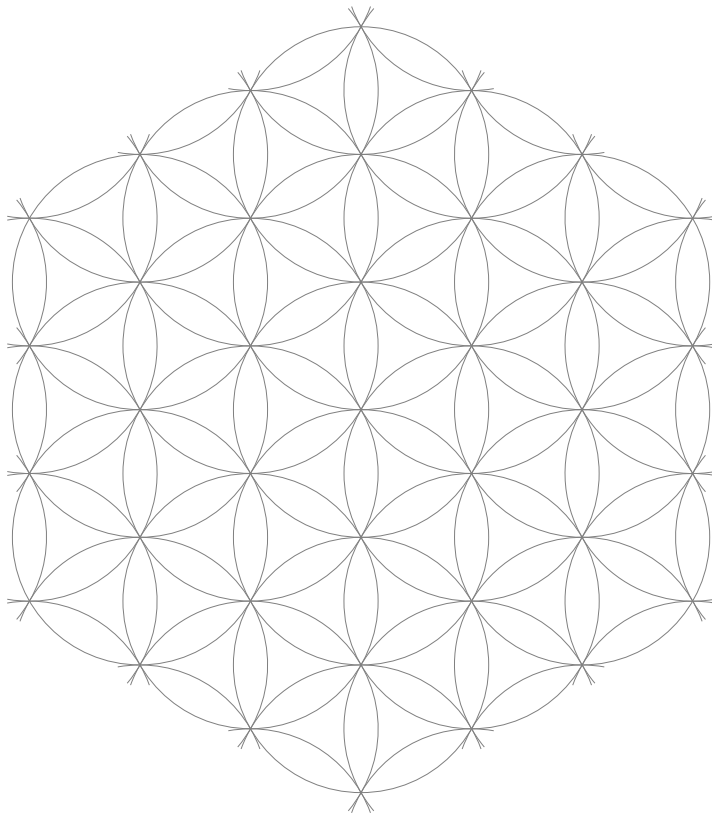

```

\begin{tikzpicture}[scale=.75]
  \tkzSetUpLine[line width=2pt,color=teal!80!black]
  \tkzSetUpCompass[line width=2pt,color=teal!80!black]
  \tkzDefPoint(0,0){O} \tkzDefPoint(2.25,0){A}
  \tkzDrawCircle(O,A)
\foreach \i in {0,...,5}{
  \tkzDefPointBy[rotation= center O angle 30+60*\i](A)\tkzGetPoint{a\i}
  \tkzDefPointBy[rotation= center {a\i} angle 120](O)\tkzGetPoint{b\i}
  \tkzDefPointBy[rotation= center {a\i} angle 180](O)\tkzGetPoint{c\i}
  \tkzDefPointBy[rotation= center {c\i} angle 120](a\i)\tkzGetPoint{d\i}
  \tkzDefPointBy[rotation= center {c\i} angle 60](d\i)\tkzGetPoint{f\i}
  \tkzDefPointBy[rotation= center {d\i} angle 60](b\i)\tkzGetPoint{e\i}
  \tkzDefPointBy[rotation= center {f\i} angle 60](d\i)\tkzGetPoint{g\i}
  \tkzDefPointBy[rotation= center {d\i} angle 60](e\i)\tkzGetPoint{h\i}
  \tkzDefPointBy[rotation= center {e\i} angle 180](b\i)\tkzGetPoint{k\i}
  \tkzDrawCircle(a\i,O)
  \tkzDrawCircle(b\i,a\i)
  \tkzDrawCircle(c\i,a\i)
  \tkzDrawArc[rotate](f\i,d\i)(-120)
  \tkzDrawArc[rotate](e\i,d\i)(180)
  \tkzDrawArc[rotate](d\i,f\i)(180)
  \tkzDrawArc[rotate](g\i,f\i)(60)
  \tkzDrawArc[rotate](h\i,d\i)(60)
  \tkzDrawArc[rotate](k\i,e\i)(60)
}
  \tkzClipCircle(O,f0)
\end{tikzpicture}

```

45.17. Hexagon Inscribed

Hexagon Inscribed

To inscribe a regular hexagon in a given equilateral triangle perfectly inside it (no borders).

45.17.1. Hexagon Inscribed version 1

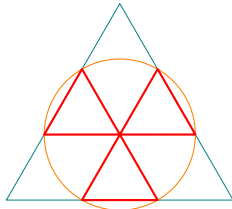

```
\begin{tikzpicture}[scale=.5]
\pgfmathsetmacro{\c}{6}
\tkzDefPoints{0/0/A,\c/0/B}
\tkzDefTriangle[equilateral](A,B)\tkzGetPoint{C}
\tkzDefTriangleCenter[centroid](A,B,C)
\tkzGetPoint{I}
\tkzDefPointBy[homothety=center A ratio 1./3](B)
\tkzGetPoint{c1}
\tkzInterLC(B,C)(I,c1)\tkzGetPoints{a1}{a2}
\tkzInterLC(A,C)(I,c1)\tkzGetPoints{b1}{b2}
\tkzInterLC(A,B)(I,c1)\tkzGetPoints{c1}{c2}
\tkzDrawPolygon(A,B,C)
\tkzDrawCircle[thin,orange](I,c1)
\tkzDrawPolygon[red,thick](a2,a1,b2,b1,c2,c1)
\end{tikzpicture}
```

45.17.2. Hexagon Inscribed version 2

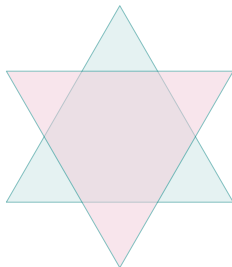

```
\begin{tikzpicture}[scale=.5]
\pgfmathsetmacro{\c}{6}
\tkzDefPoints{0/0/A,\c/0/B}
\tkzDefTriangle[equilateral](A,B)\tkzGetPoint{C}
\tkzDefTriangleCenter[centroid](A,B,C)
\tkzGetPoint{I}
\tkzDefPointsBy[rotation=center I%
angle 60](A,B,C){a,b,c}
\tkzDrawPolygon[fill=teal!20,opacity=.5](A,B,C)
\tkzDrawPolygon[fill=purple!20,opacity=.5](a,b,c)
\end{tikzpicture}
```

45.18. Power of a point with respect to a circle

Power of a point with respect to a circle

$$\overline{MA} \times \overline{MB} = MT^2 = MO^2 - OT^2$$

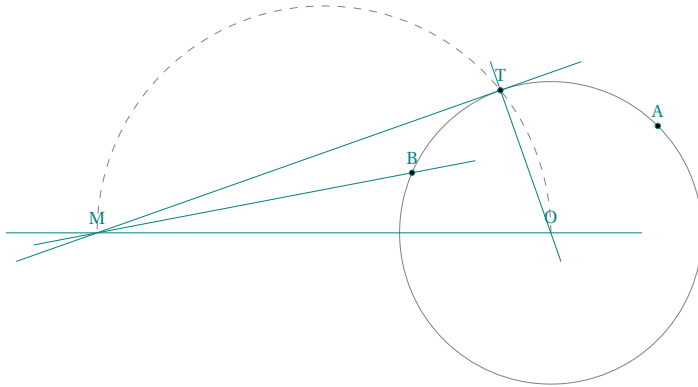

```

\begin{tikzpicture}
  \pgfmathsetmacro{\r}{2}%
  \pgfmathsetmacro{\x0}{6}%
  \pgfmathsetmacro{\xE}{\x0-\r}%
  \tkzDefPoints{O/O/M,\x0/O/O,\xE/Q/E}
  \tkzDefCircle[diameter](M,O)
  \tkzGetPoint{I}
  \tkzInterCC(I,O)(O,E) \tkzGetPoints{T}{T'}
  \tkzDefShiftPoint[O](45:2){B}
  \tkzInterLC(M,B)(O,E) \tkzGetPoints{A}{B}
  \tkzDrawCircle(O,E)
  \tkzDrawSemiCircle[dashed](I,O)
  \tkzDrawLine(M,O)
  \tkzDrawLines(M,T O,T M,B)
  \tkzDrawPoints(A,B,T)
  \tkzLabelPoints[above](A,B,O,M,T)
\end{tikzpicture}

```

45.19. Radical axis of two non-concentric circles

Radical axis of two non-concentric circles

From Wikipedia : *In geometry, the radical axis of two non-concentric circles is the set of points whose power with respect to the circles are equal. For this reason the radical axis is also called the power line or power bisector of the two circles. The notation radical axis was used by the French mathematician M. Chasles as axe radical.*

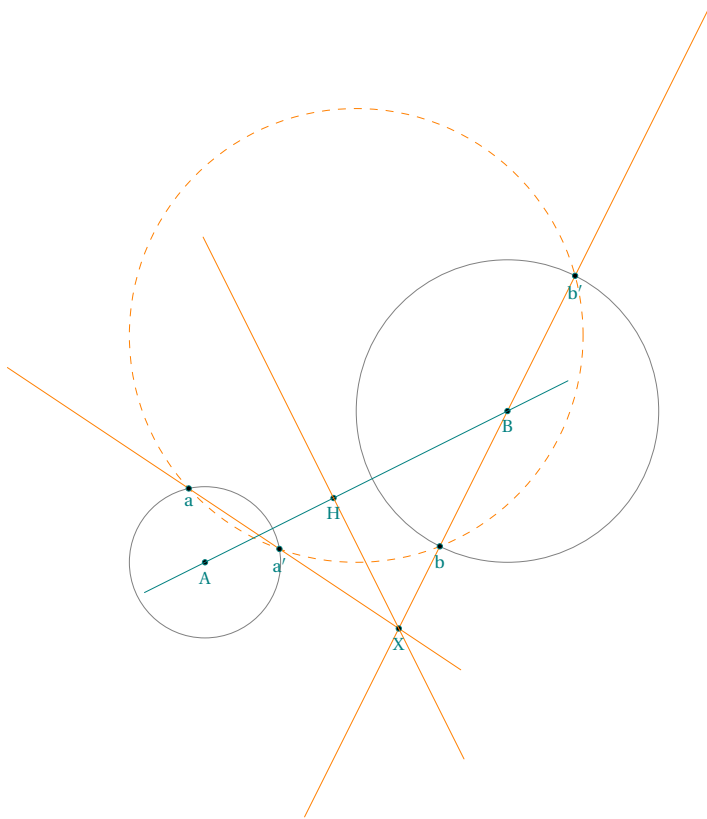

```

\begin{tikzpicture}
\tkzDefPoints{0/0/A,4/2/B,2/3/K}
\tkzDefCircle[R](A,1)\tkzGetPoint{a}
\tkzDefCircle[R](B,2)\tkzGetPoint{b}
\tkzDefCircle[R](K,3)\tkzGetPoint{k}
\tkzDrawCircles(A,a B,b)
\tkzDrawCircle[dashed,new](K,k)
\tkzInterCC(A,a)(K,k)\tkzGetPoints{a}{a'}
\tkzInterCC(B,b)(K,k)\tkzGetPoints{b}{b'}
\tkzDrawLines[new,add=2 and 2](a,a')
\tkzDrawLines[new,add=1 and 1](b,b')
\tkzInterLL(a,a')(b,b')\tkzGetPoint{X}
\tkzDefPointBy[projection= onto A--B](X)\tkzGetPoint{H}
\tkzDrawPoints(A,B,H,X,a,b,a',b')
\tkzDrawLine(A,B)
\tkzDrawLine[add= 1 and 2,new](X,H)
\tkzLabelPoints(A,B,H,X,a,b,a',b')
\end{tikzpicture}

```

45.20. External homothetic center

External homothetic center

From Wikipedia: *Given two nonconcentric circles, draw radii parallel and in the same direction. Then the line joining the extremities of the radii passes through a fixed point on the line of centers which divides that line externally in the ratio of radii. This point is called the external homothetic center, or external center of similitude (Johnson 1929, pp. 19-20 and 41).*

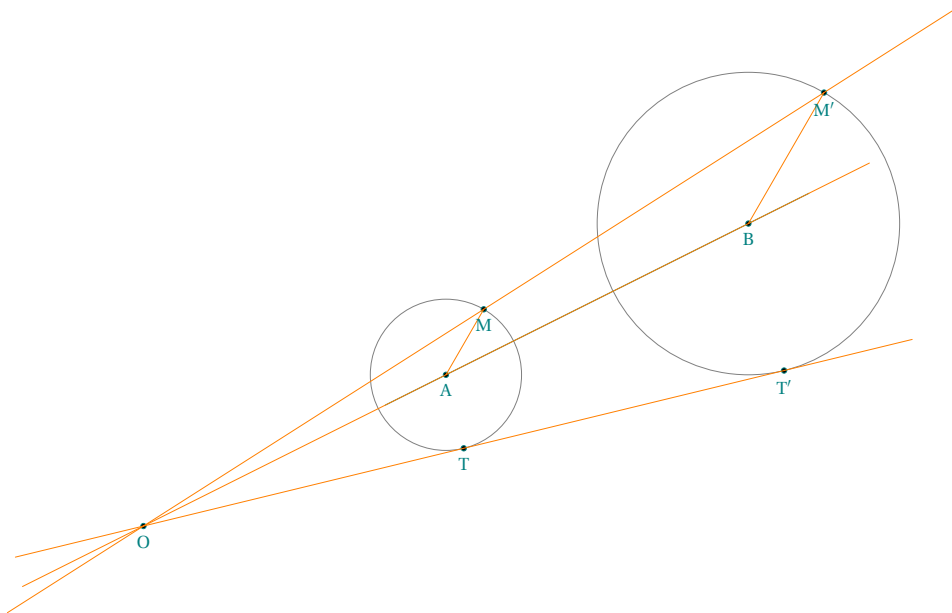

```

\begin{tikzpicture}
\tkzDefPoints{O/Q/A,4/2/B,2/3/K}
\tkzDefCircle[R](A,1)\tkzGetPoint{a}
\tkzDefCircle[R](B,2)\tkzGetPoint{b}
\tkzDrawCircles(A,a B,b)
\tkzDrawLine(A,B)
\tkzDefShiftPoint[A](6Q:1){M}
\tkzDefShiftPoint[B](6Q:2){M'}
\tkzInterLL(A,B)(M,M') \tkzGetPoint{O}
\tkzDefLine[tangent from = O](B,M') \tkzGetPoints{X}{T'}
\tkzDefLine[tangent from = O](A,M) \tkzGetPoints{X}{T}
\tkzDrawPoints(A,B,O,T,T',M,M')
\tkzDrawLines[new](O,B O,T' O,M')
\tkzDrawSegments[new](A,M B,M')
\tkzLabelPoints(A,B,O,T,T',M,M')
\end{tikzpicture}

```

45.21. Tangent lines to two circles

Tangent lines to two circles

For two circles, there are generally four distinct lines that are tangent to both if the two circles are outside each other. For two of these, the external tangent lines, the circles fall on the same side of the line; the external tangent lines intersect in the external homothetic center

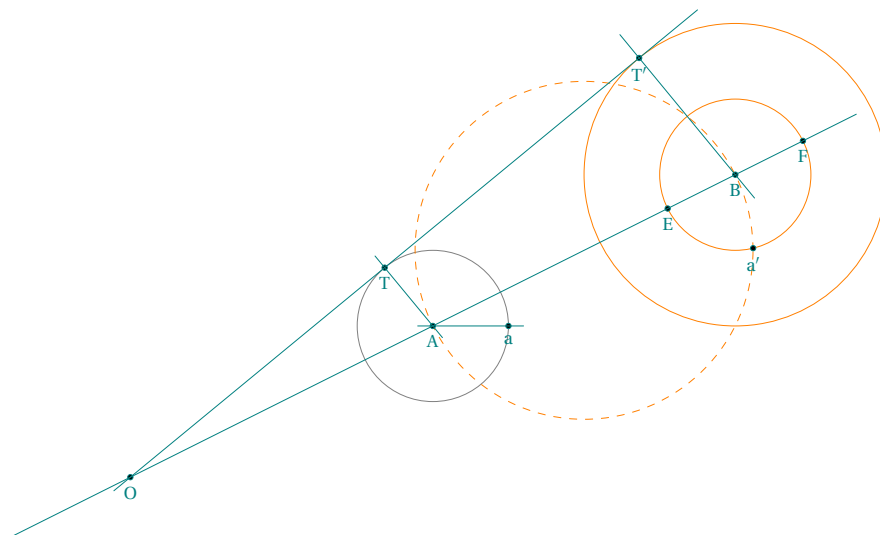

```

\begin{tikzpicture}
  \pgfmathsetmacro{\r}{1}%
  \pgfmathsetmacro{\R}{2}%
  \pgfmathsetmacro{\rt}{\R-\r}%
  \tkzDefPoints{O/O/A,4/2/B,2/3/K}
  \tkzDefMidPoint(A,B) \tkzGetPoint{I}
  \tkzInterLC[R](A,B)(B,\rt) \tkzGetPoints{E}{F}
  \tkzInterCC(I,B)(B,F) \tkzGetPoints{a}{a'}
  \tkzInterLC[R](B,a)(B,\R) \tkzGetPoints{X'}{T'}
  \tkzDefLine[tangent at=T'](B) \tkzGetPoint{h}
  \tkzInterLL(T',h)(A,B) \tkzGetPoint{O}
  \tkzInterLC[R](O,T')(A,\r) \tkzGetPoints{T}{T}
  \tkzDefCircle[R](A,\r) \tkzGetPoint{a}
  \tkzDefCircle[R](B,\R) \tkzGetPoint{b}
  \tkzDefCircle[R](B,\rt) \tkzGetPoint{c}
  \tkzDrawCircles(A,a)
  \tkzDrawCircles[orange](B,b B,c)
  \tkzDrawCircle[orange,dashed](I,B)
  \tkzDrawPoints(O,A,B,a,a',E,F,T',T)
  \tkzDrawLines(O,B A,a B,T' A,T)
  \tkzDrawLines[add= 1 and 3](T',h)
  \tkzLabelPoints(O,A,B,a,a',E,F,T,T')
\end{tikzpicture}

```

45.22. Tangent lines to two circles with radical axis

Tangent lines to two circles with radical axis

As soon as two circles are not concentric, we can construct their radical axis, the set of points of equal power with respect to the two circles. We know that the radical axis is a line orthogonal to the line of the centers. Note that if we specify P and Q as the points of contact of one of the common exterior tangents with the two circles and D and E as the points of the circles outside $[AB]$, then (DP) and (EQ) intersect on the radical axis of the two circles. We will show that this property is always true and that it allows us to construct common tangents, even when the circles have the same radius.

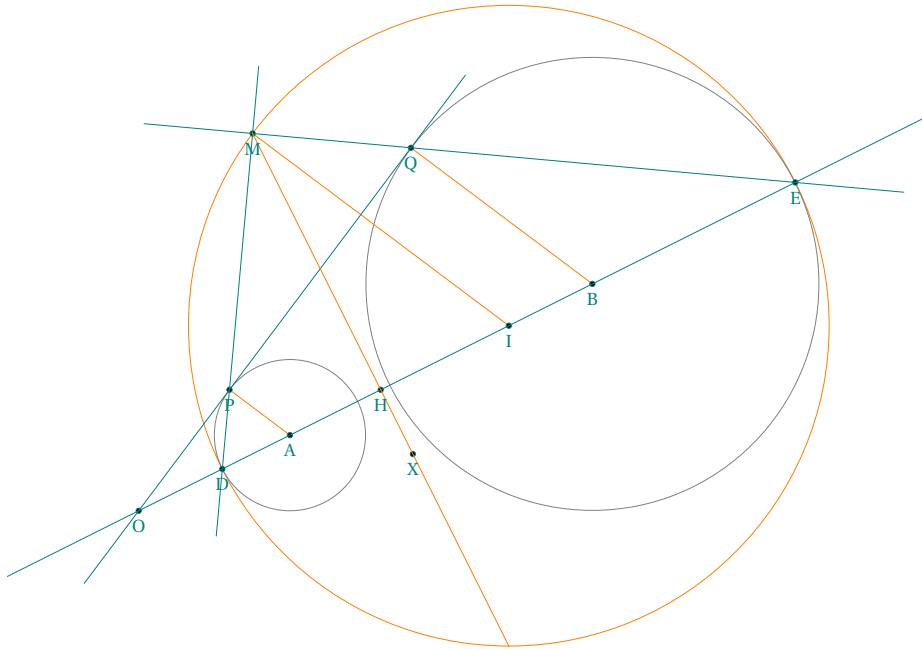

```

\begin{tikzpicture}
\tkzDefPoints{O/Q/A,4/2/B,2/3/K}
\tkzDefCircle[R](A,1) \tkzGetPoint{a}
\tkzDefCircle[R](B,3) \tkzGetPoint{b}
\tkzInterCC[R](A,1)(K,3) \tkzGetPoints{a}{a'}
\tkzInterCC[R](B,3)(K,3) \tkzGetPoints{b}{b'}
\tkzInterLL(a,a')(b,b') \tkzGetPoint{X}
\tkzDefPointBy[projection= onto A--B](X) \tkzGetPoint{H}
\tkzGetPoint{C}
\tkzInterLC[R](A,B)(B,3) \tkzGetPoints{b1}{E}
\tkzInterLC[R](A,B)(A,1) \tkzGetPoints{D}{a2}
\tkzDefMidPoint(D,E) \tkzGetPoint{I}
\tkzDrawCircle[orange](I,D)
\tkzInterLC(X,H)(I,D) \tkzGetPoints{M}{M'}
\tkzInterLC(M,D)(A,D) \tkzGetPoints{P}{P'}
\tkzInterLC(M,E)(B,E) \tkzGetPoints{Q}{Q}
\tkzInterLL(P,Q)(A,B) \tkzGetPoint{O}
\tkzDrawCircles(A,a B,b)
\tkzDrawSegments[orange](A,P I,M B,Q)
\tkzDrawPoints(A,B,D,E,M,I,O,P,Q,X,H)
\tkzDrawLines(O,E M,D M,E O,Q)
\tkzDrawLine[add= 3 and 4,orange](X,H)
\tkzLabelPoints(A,B,D,E,M,I,O,P,Q,X,H)
\end{tikzpicture}

```

45.23. Middle of a segment with a compass

Tangent lines to two circles with radical axis

This example involves determining the middle of a segment, using only a compass.

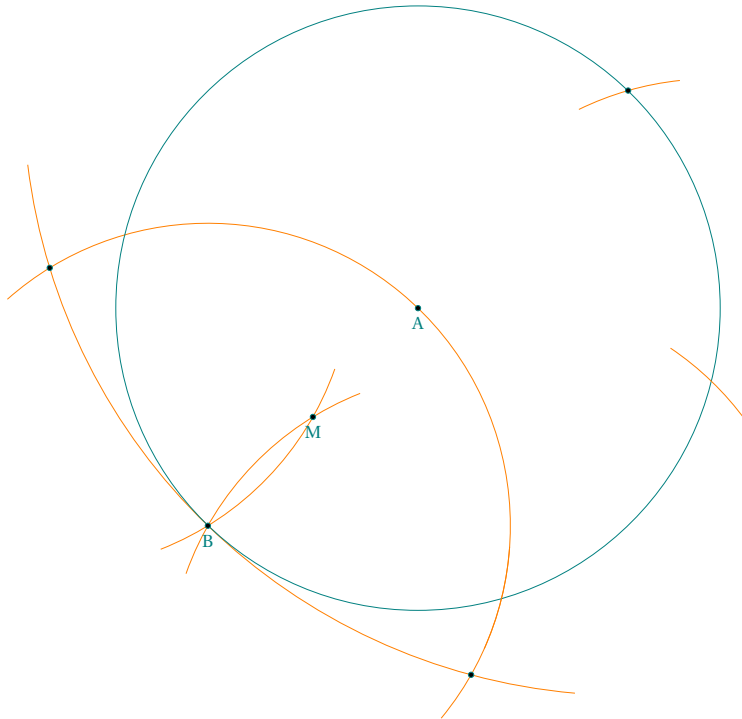

```

\begin{tikzpicture}
\tkzDefPoint(0,0){A}
\tkzDefRandPointOn[circle= center A radius 4] \tkzGetPoint{B}
\tkzDefPointBy[rotation= center A angle 180] (B) \tkzGetPoint{C}
\tkzInterCC(A,B) (B,A) \tkzGetPoints{I}{I'}
\tkzInterCC(A,I) (I,A) \tkzGetPoints{J}{J'}
\tkzInterCC(B,A) (C,B) \tkzGetPoints{D}{D'}
\tkzInterCC(D,B) (E,B) \tkzGetPoints{M}{M'}
\tkzSetUpArc[color=orange,style=solid,delta=10]
\tkzDrawArc(C,D) (E)
\tkzDrawArc(B,E) (D)
\tkzDrawCircle[color=teal,line width=.2pt] (A,B)
\tkzDrawArc(D,B) (M)
\tkzDrawArc(E,M) (B)
\tkzCompass[color=orange,style=solid] (B,I I,J J,C)
\tkzDrawPoints(A,B,C,D,E,M)
\tkzLabelPoints(A,B,M)
\end{tikzpicture}

```

45.24. Definition of a circle `_Apollonius_`Definition of a circle `_Apollonius_`

From Wikipedia : *Apollonius showed that a circle can be defined as the set of points in a plane that have a specified ratio of distances to two fixed points, known as foci. This Apollonian circle is the basis of the Apollonius pursuit problem. ... The solutions to this problem are sometimes called the circles of Apollonius.*

Explanation

A circle is the set of points in a plane that are equidistant from a given point O . The distance r from the center is called the radius, and the point O is called the center. It is the simplest definition but it is not the only one. Apollonius of Perga gives another definition : The set of all points whose distances from two fixed points are in a constant ratio is a circle.

With `tkz-euclide` is easy to show you the last definition

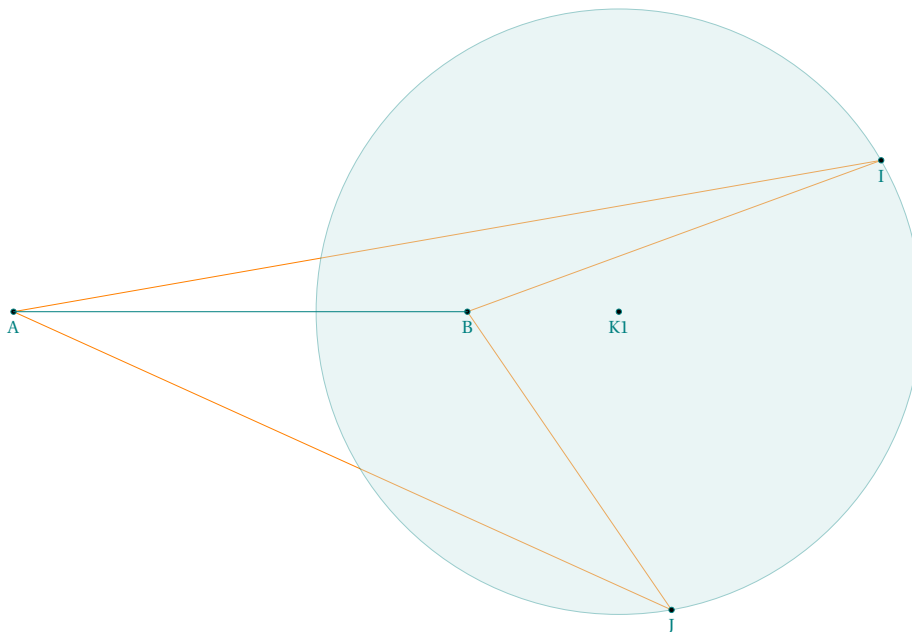

```
\begin{tikzpicture}[scale=1.5]
  % Firstly we defined two fixed point.
  % The figure depends of these points and the ratio K
  \tkzDefPoint(0,0){A}
  \tkzDefPoint(4,0){B}
  % tkz-euclide.sty knows about the apollonius's circle
  % with K=2 we search some points like I such as IA=2 x IB
  \tkzDefCircle[apollonius,K=2](A,B) \tkzGetPoints{K1}{k}
  \tkzDefPointOnCircle[through= center K1 angle 30 point k]
  \tkzGetPoint{I}
  \tkzDefPointOnCircle[through= center K1 angle 280 point k]
  \tkzGetPoint{J}
  \tkzDrawSegments[new](A,I I,B A,J J,B)
  \tkzDrawCircle[color = teal,fill=teal!20,opacity=.4](K1,k)
  \tkzDrawPoints(A,B,K1,I,J)
  \tkzDrawSegment(A,B)
  \tkzLabelPoints[below,font=\scriptsize](A,B,K1,I,J)
\end{tikzpicture}
```

45.25. Application of Inversion : Pappus chain

Pappus chain

From Wikipedia *In geometry, the Pappus chain is a ring of circles between two tangent circles investigated by Pappus of Alexandria in the 3rd century AD.*

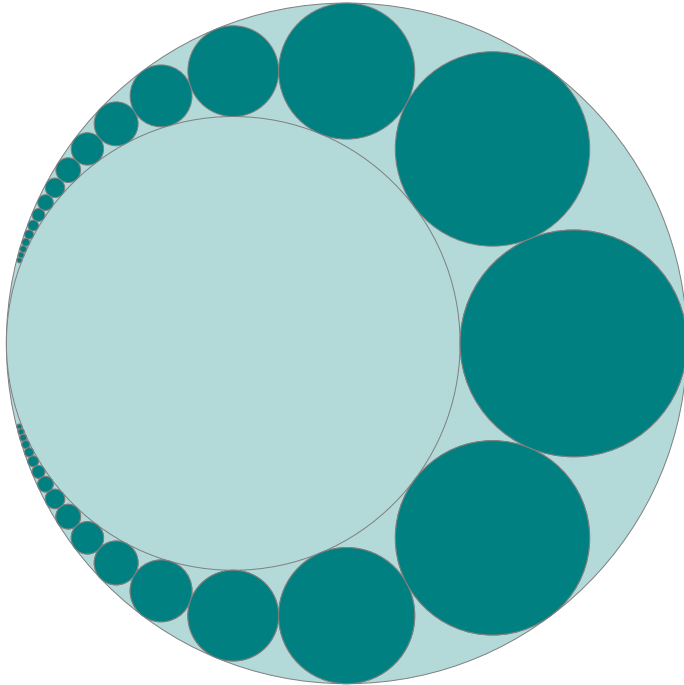

```

\begin{tikzpicture}[ultra thin]
  \pgfmathsetmacro{\xB}{6}%
  \pgfmathsetmacro{\xC}{9}%
  \pgfmathsetmacro{\xD}{(\xC*\xC)/\xB}%
  \pgfmathsetmacro{\xJ}{(\xC+\xD)/2}%
  \pgfmathsetmacro{\r}{\xD-\xJ}%
  \pgfmathsetmacro{\nc}{16}%
  \tkzDefPoints{0/0/A, \xB/0/B, \xC/0/C, \xD/0/D}
  \tkzDefCircle[diameter](A,C) \tkzGetPoint{x}
  \tkzDrawCircle[fill=teal!30](x,C)
  \tkzDefCircle[diameter](A,B) \tkzGetPoint{y}
  \tkzDrawCircle[fill=teal!30](y,B)
  \foreach \i in {-\nc,...,0,...,\nc}
  {\tkzDefPoint(\xJ,2*\r*\i){J}
   \tkzDefPoint(\xJ,2*\r*\i-\r){H}
   \tkzDefCircleBy[inversion = center A through C](J,H)
   \tkzDrawCircle[fill=teal](tkzFirstPointResult,tkzSecondPointResult)}
\end{tikzpicture}

```

45.26. Book of lemmas proposition 1 Archimedes

Book of lemmas proposition 1 Archimedes

If two circles touch at A, and if [CD], [EF] be parallel diameters in them, A, C and E are aligned.

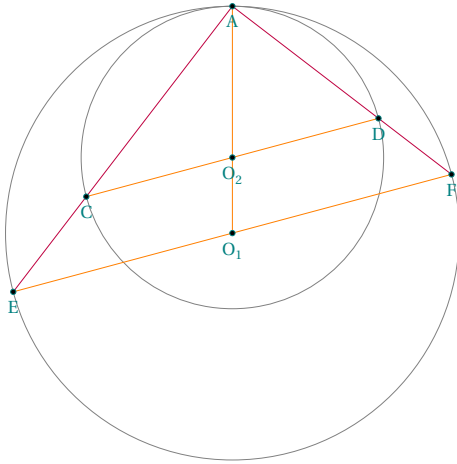

```
\begin{tikzpicture}
  \tkzDefPoints{0/0/O_1,0/1/O_2,0/3/A}
  \tkzDefPoint(15:3){F}
  \tkzInterLC(F,O_1)(O_1,A) \tkzGetSecondPoint{E}
  \tkzDefLine[parallel=through O_2](E,F)
  \tkzGetPoint{x}
  \tkzInterLC(x,O_2)(O_2,A) \tkzGetPoints{D}{C}
  \tkzDrawCircles(O_1,A O_2,A)
  \tkzDrawSegments[new](O_1,A E,F C,D)
  \tkzDrawSegments[purple](A,E A,F)
  \tkzDrawPoints(A,O_1,O_2,E,F,C,D)
  \tkzLabelPoints(A,O_1,O_2,E,F,C,D)
\end{tikzpicture}
```

$(CD) \parallel (EF)$ (AO_1) is secant to these two lines so $\widehat{AO_2C} = \widehat{AO_1E}$.

Since the triangles AO_2C and AO_1E are isosceles the angles at the base are equal $\widehat{ACO_2} = \widehat{AEO_1} = \widehat{CAO_2} = \widehat{EAO_1}$. Thus A, C and E are aligned

45.27. Book of lemmas proposition 6 Archimedes

Book of lemmas proposition 6 Archimedes

Let AC, the diameter of a semicircle, be divided at B so that $AC/AB = \phi$ or in any ratio. Describe semicircles within the first semicircle and on AB, BC as diameters, and suppose a circle drawn touching the all three semicircles. If GH be the diameter of this circle, to find relation between GH and AC.

```

\begin{tikzpicture}
\tkzDefPoints{O/O/A,12/O/C}
\tkzDefGoldenRatio(A,C)
\tkzDefMidPoint(A,B)
\tkzDefMidPoint(A,B)
\tkzDefMidPoint(B,C)
\tkzDefExtSimilitudeCenter(O_1,A)(O_2,B)
\tkzDefIntSimilitudeCenter(O,A)(O_1,A)
\tkzDefIntSimilitudeCenter(O,C)(O_2,C)
\tkzInterCC(O_1,A)(M_2,C)
\tkzInterCC(O_2,C)(M_1,A)
\tkzInterCC(O,A)(M_O,B)
\tkzInterLL(O_1,E)(O_2,F)
\tkzDefCircle[circum](E,F,B)
\tkzInterLC(A,D)(O_1,A)
\tkzInterLC(C,D)(O_2,B)
\tkzInterLC[common=D](A,D)(O_3,D)
\tkzInterLC[common=D](C,D)(O_3,D)
\tkzInterLL(C,G)(B,K)
\tkzInterLL(A,H)(B,I)
\tkzInterLL(L,G)(A,C)
\tkzInterLL(M,H)(A,C)
\tkzDrawCircles[red,thin](O_3,F)
\tkzDrawCircles[new,thin](O_4,B)
\tkzDrawSemiCircles[teal](O,C)(O_1,B)(O_2,C)
\tkzDrawSemiCircles[green](M_2,C)
\tkzDrawSemiCircles[green,swap](M_1,A)
\tkzDrawSegment(A,C)
\tkzDrawSegments[new](O_1,O_3)(O_2,O_3)
\tkzDrawSegments[new,very thin](B,H)(C,G)(A,H)(G,N)(H,P)
\tkzDrawSegments[new,very thin](B,D)(A,D)(C,D)(G,H)(I,B)(K,B)(B,G)
\tkzDrawPoints(A,B,C,M_1,M_2,E,O_3,F,D,O_4,O_1,O_2,I,K,G,H,L,P,N,M)
\tkzLabelPoints[font=\scriptsize](A,B,C,M_1,M_2,F,O_1,O_2,I,K,G,H,L,M,N)
\tkzLabelPoints[font=\scriptsize,right](E,O_3,D,O_4,P)
\end{tikzpicture}

```

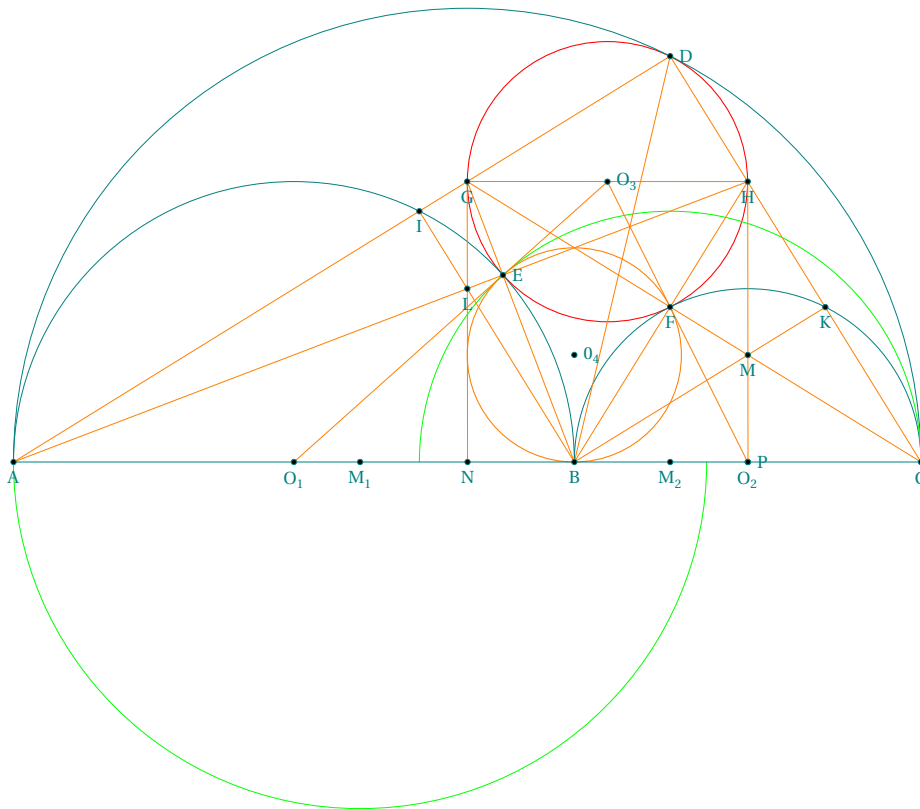

Let GH be the diameter of the circle which is parallel to AC, and let the circle touch the semicircles on AC, AB, BC in D, E, F respectively.

Then, by Prop. 1 A,G and D are aligned, ainsi que D, H and C.

For a like reason A E and H are aligned, C F and G are aligned, as also are B E and G, B F and H.

Let (AD) meet the semicircle on [AC] at I, and let (BD) meet the semicircle on [BC] in K. Join CI, CK meeting AE, BF in L, M, and let GL, HM produced meet AB in N, P respectively.

Now, in the triangle AGB, the perpendiculars from A, C on the opposite sides meet in L. Therefore by the properties of triangles, (GN) is perpendicular to (AC). Similarly (HP) is perpendicular to (BC).

Again, since the angles at I, K, D are right, (CK) is parallel to (AD), and (CI) to (BD).

Therefore

$$\frac{AB}{BC} = \frac{AL}{LH} = \frac{AN}{NP} \quad \text{and} \quad \frac{BC}{AB} = \frac{CM}{MG} = \frac{PC}{NP}$$

hence

$$\frac{AN}{NP} = \frac{NP}{PC} \quad \text{so} \quad NP^2 = AN \times PC$$

Now suppose that B divides [AC] according to the divine proportion that is :

$$\phi = \frac{AB}{BC} = \frac{AC}{AB} \quad \text{then} \quad AN = \phi NP \quad \text{and} \quad NP = \phi PC$$

We have

$$AC = AN + NP + PC \quad \text{either} \quad AB + BC = AN + NP + PC \quad \text{or} \quad (\phi + 1)BC = AN + NP + PC$$

we get

$$(\phi + 1)BC = \phi NP + NP + PC = (\phi + 1)NP + PC = \phi(\phi + 1)PC + PC = \phi^2 + \phi + 1)PC$$

as

$$\phi^2 = \phi + 1 \quad \text{then} \quad (\phi + 1)BC = 2(\phi + 1)PC \quad \text{i.e.} \quad BC = 2PC$$

That is, p is the middle of the segment BC .

Part of the proof from <https://www.cut-the-knot.org>

45.28. "The" Circle of APOLLONIUS

The Apollonius circle of a triangle `_Apollonius_`

The circle which touches all three excircles of a triangle and encompasses them is often known as "the" Apollonius circle (Kimberling 1998, p. 102)

Explanation

The purpose of the first examples was to show the simplicity with which we could recreate these propositions. With TikZ you need to do calculations and use trigonometry while with `tkz-euclide` you only need to build simple objects

But don't forget that behind or far above `tkz-euclide` there is TikZ. I'm only creating an interface between TikZ and the user of my package.

The last example is very complex and it is to show you all that we can do with `tkz-euclide`.

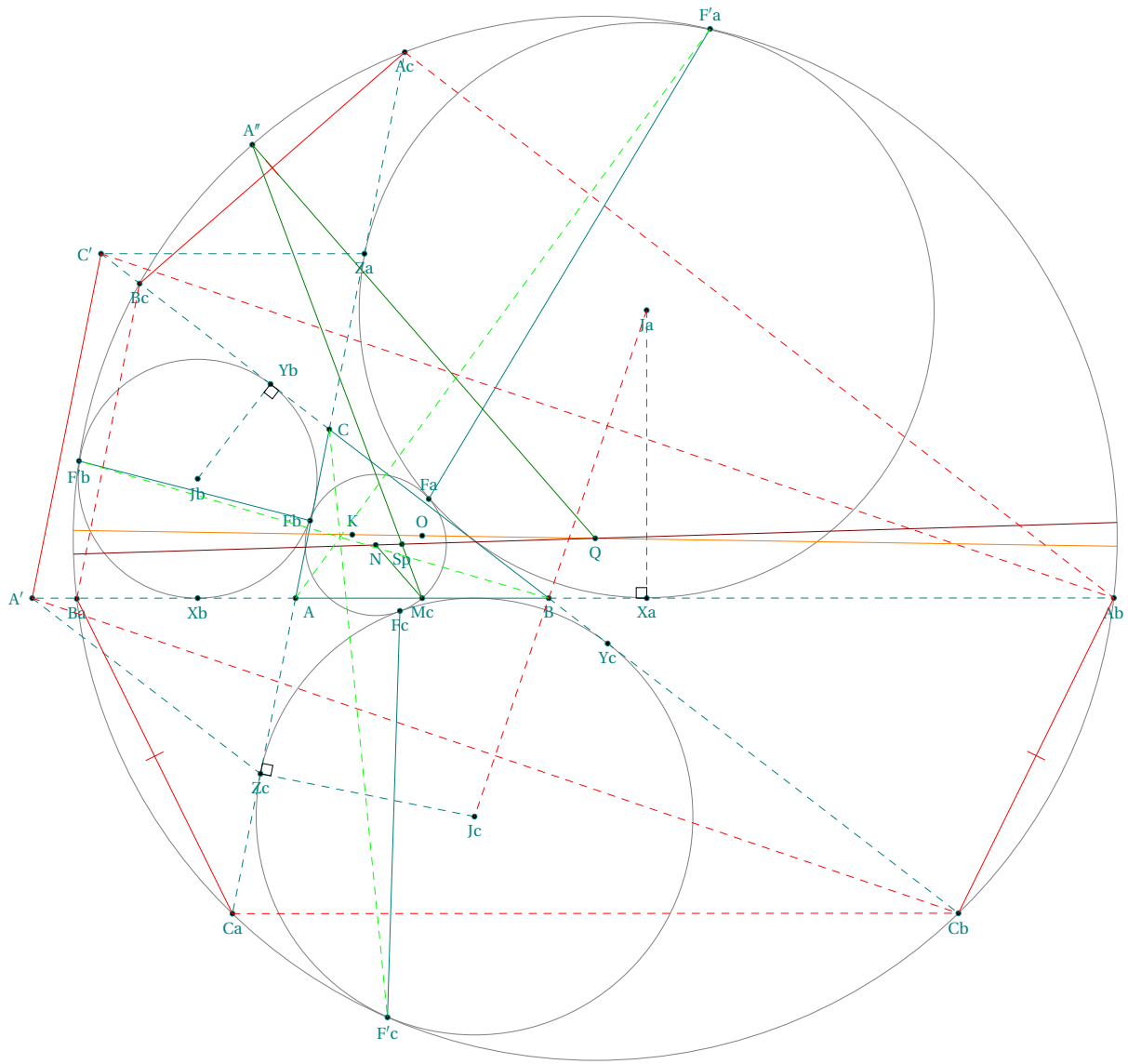

```

\begin{tikzpicture}[scale=.6]
\tkzDefPoints{0/0/A,6/0/B,0.8/4/C}
\tkzDefTriangleCenter[euler](A,B,C) \tkzGetPoint{N}
\tkzDefTriangleCenter[circum](A,B,C) \tkzGetPoint{O}
\tkzDefTriangleCenter[lemoine](A,B,C) \tkzGetPoint{K}
\tkzDefTriangleCenter[ortho](A,B,C) \tkzGetPoint{H}
\tkzDefSpcTriangle[excentral,name=J](A,B,C){a,b,c}
\tkzDefSpcTriangle[centroid,name=M](A,B,C){a,b,c}
\tkzDefCircle[in](Ma,Mb,Mc) \tkzGetPoint{Sp} % Sp Spieker center
\tkzDefProjExcenter[name=J](A,B,C)(a,b,c){Y,Z,X}
\tkzDefLine[parallel=through Za](A,B) \tkzGetPoint{Xc}
\tkzInterLL(Za,Xc)(C,B) \tkzGetPoint{C'}
\tkzDefLine[parallel=through Zc](B,C) \tkzGetPoint{Ya}
\tkzInterLL(Zc,Ya)(A,B) \tkzGetPoint{A'}
\tkzDefPointBy[reflection= over Ja--Jc](C') \tkzGetPoint{Ab}
\tkzDefPointBy[reflection= over Ja--Jc](A') \tkzGetPoint{Cb}
\tkzInterLL(K,O)(N,Sp) \tkzGetPoint{Q}
\tkzInterLC(A,B)(Q,Cb) \tkzGetFirstPoint{Ba}
\tkzInterLC(A,C)(Q,Cb) \tkzGetPoints{Ac}{Ca}
\tkzInterLC(B,C')(Q,Cb) \tkzGetFirstPoint{Bc}
\tkzInterLC[next to=Ja](Ja,Q)(Q,Cb) \tkzGetFirstPoint{F'a}
\tkzInterLC[next to=Jc](Jc,Q)(Q,Cb) \tkzGetFirstPoint{F'c}
\tkzInterLC[next to=Jb](Jb,Q)(Q,Cb) \tkzGetFirstPoint{F'b}
\tkzInterLC[common=F'a](Sp,F'a)(Ja,F'a) \tkzGetFirstPoint{Fa}
\tkzInterLC[common=F'b](Sp,F'b)(Jb,F'b) \tkzGetFirstPoint{Fb}
\tkzInterLC[common=F'c](Sp,F'c)(Jc,F'c) \tkzGetFirstPoint{Fc}
\tkzInterLC(Mc,Sp)(Q,Cb) \tkzGetFirstPoint{A''}
\tkzDefCircle[euler](A,B,C) \tkzGetPoints{E}{e}
\tkzDefCircle[ex](C,A,B) \tkzGetPoints{Ea}{a}
\tkzDefCircle[ex](A,B,C) \tkzGetPoints{Eb}{b}
\tkzDefCircle[ex](B,C,A) \tkzGetPoints{Ec}{c}
% Calculations are done, now you can draw, mark and label
\tkzDrawCircles(Q,Cb E,e)%
\tkzDrawCircles(Eb,b Ea,a Ec,c)
\tkzDrawPolygon(A,B,C)
\tkzDrawSegments[dashed](A,A' C,C' A',Zc Za,C' B,Cb B,Ab A,Ca)
\tkzDrawSegments[dashed](C,Ac Ja,Xa Jb,Yb Jc,Zc)
\begin{scope}
\tkzClipCircle(Q,Cb) % We limit the drawing of the lines
\tkzDrawLine[add=5 and 12,orange](K,O)
\tkzDrawLine[add=12 and 28,red!50!black](N,Sp)
\end{scope}
\tkzDrawPoints(A,B,C,K,Ja,Jb,Jc,Q,N,O,Sp,Mc,Xa,Xb,Yb,Yc,Za,Zc)
\tkzDrawPoints(A',C',A'',Ab,Cb,Bc,Ca,Ac,Ba,Fa,Fb,Fc,F'a,F'b,F'c)
\tkzLabelPoints(Ja,Jb,Jc,Q,Xa,Xb,Za,Zc,Ab,Cb,Bc,Ca,Ac,Ba,F'b)
\tkzLabelPoints[above](O,K,F'a,Fa,A'')
\tkzLabelPoints[below](B,F'c,Yc,N,Sp,Fc,Mc)
\tkzLabelPoints[left](A',C',Fb)
\tkzLabelPoints[right](C)
\tkzLabelPoints[below right](A)
\tkzLabelPoints[above right](Yb)
\tkzDrawSegments(Fc,F'c Fb,F'b Fa,F'a)
\tkzDrawSegments[color=green!50!black](Mc,N Mc,A'' A'',Q)
\tkzDrawSegments[color=red,dashed](Ac,Ab Ca,Cb Ba,Bc Ja,Jc A',Cb C',Ab)
\tkzDrawSegments[color=red](Cb,Ab Bc,Ac Ba,Ca A',C')
\tkzMarkSegments[color=red,mark=|](Cb,Ab Bc,Ac Ba,Ca)
\tkzMarkRightAngles(Jc,Zc,A Ja,Xa,B Jb,Yb,C)
\tkzDrawSegments[green,dashed](A,F'a B,F'b C,F'c)
\end{tikzpicture}

```

Part X.

FAQ

46. FAQ

46.1. Most common errors

For the moment, I'm basing myself on my own, because having changed syntax several times, I've made a number of mistakes. This section is going to be expanded. With version 4.05 new problems may appear.

- The mistake I make most often is to forget to put an "s" in the macro used to draw more than one object: like `\tkzDrawSegment(s)` or `\tkzDrawCircle(s)` ok like in this example `\tkzDrawPoint(A,B)` when you need `\tkzDrawPoints(A,B);`
- Don't forget that since version 4 the unit is obligatorily the "cm" it is thus necessary to withdraw the unit like here `\tkzDrawCircle[R](0,3cm)` which becomes `\tkzDrawCircle[R](0,3)`. The traditional options of TikZ keep their units example `below right = 12pt` on the other hand one will write `size=1.2` to position an arc in `\tkzMarkAngle;`
- The following error still happens to me from time to time. A point that is created has its name in brackets while a point that is used either as an option or as a parameter has its name in braces. Example `\tkzGetPoint(A)` When defining an object, use braces and not brackets, so write: `\tkzGetPoint{A};`
- The changes in obtaining the points of intersection between lines and circles sometimes exchange the solutions, this leads either to a bad figure or to an error.
- `\tkzGetPoint{A}` in place of `\tkzGetFirstPoint{A}`. When a macro gives two points as results, either we retrieve these points using `\tkzGetPoints{A}{B}`, or we retrieve only one of the two points, using `\tkzGetFirstPoint{A}` or `\tkzGetSecondPoint{A}`. These two points can be used with the reference `tkzFirstPointResult` or `tkzSecondPointResult`. It is possible that a third point is given as `tkzPointResult;`
- Mixing options and arguments; all macros that use a circle need to know the radius of the circle. If the radius is given by a measure then the option includes a R.
- The angles are given in degrees, more rarely in radians.
- If an error occurs in a calculation when passing parameters, then it is better to make these calculations before calling the macro.
- Do not mix the syntax of `pgfmath` and `xfp`. I've often chosen `xfp` but if you prefer `pgfmath` then do your calculations before passing parameters.
- Error "dimension too large" : In some cases, this error occurs. One way to avoid it is to use the "xfp" option. When this option is used in a scope, the "veclen" function is replaced by a function dependent on "xfp". Do not use intersection macros in this scope. For example, an error occurs if you use the macro `\tkzDrawArc` with too small an angle. The error is produced by the `decoration` library when you want to place a mark on an arc. Even if the mark is absent, the error is still present.

Index

`\add`, 125
`\ang`, 117
`\Ax`, 181
`\Ay`, 181

`\coordinate`, 34

`\dAB`, 179, 180
`\Delta`, 168
`\draw (A)--(B);`, 126

`\endpgfinterruptboundingbox`, 154
Environment
 `scope`, 36, 190
 `tikzpicture`, 190
 `tikzspicture`, 190

`\foreach`, 109
`\fpeval`, 111

`\iftkzFlagCC`, 112
`\iftkzFlagLC`, 106

`\len`, 180, 181

Operating System
 Windows, 18

Package
 `fp`, 17
 `pgfmath`, 245
 `tkz-euclide`, 147
 `xfp`, 17, 18, 34, 36, 179, 245
`\pgfinterruptboundingbox`, 154
`\pgflinewidth`, 123, 124
`\pgfmathsetmacro`, 111
`\pgfresetboundingbox`, 147
`\px`, 181
`\py`, 181

`\rAB`, 41
`\rAp`, 50

standalone, 23

TeX Distributions
 MiKTeX, 18
 TeXLive, 18
TikZ Library
 `angles`, 17
 `babel`, 28
 `decoration`, 245
 `quotes`, 17
`\tikzset`, 189
`\tkzAngleResult`, 117, 119
`\tkzAutoLabelPoints`, 166
`\tkzCalcLength`, 179, 180
`\tkzCalcLength: arguments`

$(pt1,pt2)\{\text{name of macro}\}$, 179
`\tkzCalcLength`: options
 cm, 180
`\tkzCalcLength[\langle local options \rangle](\langle pt1,pt2 \rangle)`, 179
`\tkzCentroid`, 43
`\tkzClip`, 17, 28, 147, 148
`\tkzClip`: options
 space, 148
`\tkzClipBB`, 17, 149, 150
`\tkzClipCircle[out]`, 155
`\tkzClipCircle`, 96, 152
`\tkzClipCircle`: arguments
 \langle A,B \rangle , 152
`\tkzClipCircle`: options
 out, 152
`\tkzClipCircle[\langle local options \rangle](\langle A,B \rangle)`, 152
`\tkzClipPolygon[out]`, 151, 155
`\tkzClipPolygon`, 151
`\tkzClipPolygon`: arguments
 \langle pt1,pt2,pt3,... \rangle , 151
`\tkzClipPolygon`: options
 out, 151
`\tkzClipPolygon[\langle local options \rangle](\langle points list \rangle)`, 151
`\tkzClipSector(O,A)(B)`, 153
`\tkzClipSector[R](O,2)(30,90)`, 153
`\tkzClipSector[rotate](O,A)(90)`, 153
`\tkzClipSector`, 153
`\tkzClipSector`: options
 R, 153
 rotate, 153
 towards, 153
`\tkzClipSector[\langle local options \rangle](\langle O,... \rangle)(\langle ... \rangle)`, 153
`\tkzClip[\langle local options \rangle]`, 148
`\tkzcmtopt`, 181
`\tkzcmtopt`: arguments
 (number){name of macro}, 181
`\tkzcmtopt(\langle number \rangle){ \langle name of macro \rangle }`, 181
`\tkzCompass`, 138, 173
`\tkzCompass`: options
 delta, 173
 length, 173
`\tkzCompass`, 173, 174
`\tkzCompass`: options
 delta, 173
 length, 173
`\tkzCompass[\langle local options \rangle](\langle pt1,pt2 pt3,pt4,... \rangle)`, 173
`\tkzCompass[\langle local options \rangle](\langle A,B \rangle)`, 173
`\tkzDefBarycentricPoint`, 42, 44
`\tkzDefBarycentricPoint`: arguments
 $(pt1=\alpha_1, pt2=\alpha_2, \dots)$, 42
`\tkzDefBarycentricPoint(\langle pt1= α_1 , pt2= α_2 , ... \rangle)`, 42
`\tkzDefCircle[radius](A,B)`, 180
`\tkzDefCircle`, 96
`\tkzDefCircle`: arguments
 \langle pt1,pt2 \rangle or \langle pt1,pt2,pt3 \rangle , 96
`\tkzDefCircle`: options
 K, 96
 R, 96

- apollonius, 96
- circum, 96
- diameter, 96
- euler or nine, 96
- ex, 96
- in, 96
- orthogonal from, 96
- orthogonal through, 96
- spieker, 96
- `\tkzDefCircleBy`, 16, 103
- `\tkzDefCircleBy`: arguments
 - `pt1,pt2`, 103
- `\tkzDefCircleBy`: options
 - homothety, 103
 - inversion, 103
 - projection , 103
 - reflection, 103
 - rotation , 103
 - symmetry , 103
 - translation, 103
- `\tkzDefCircleBy[local options](pt1,pt2)`, 103
- `\tkzDefCirclesBy`, 103
- `\tkzDefCircle[local options](A,B) or (A,B,C)`, 96
- `\tkzDefEquiPoints`, 47
- `\tkzDefEquiPoints`: arguments
 - `(pt1,pt2)`, 47
- `\tkzDefEquiPoints`: options
 - `/compass/delta`, 47
 - `dist`, 47
 - `from=pt`, 47
 - `show`, 47
- `\tkzDefEquiPoints[local options](pt1,pt2)`, 47
- `\tkzDefExtSimilitudeCenter`, 43
- `\tkzDefGoldenRatio(A,C)`, 42
- `\tkzDefGoldenRatio`, 41, 42
- `\tkzDefGoldenRatio`: arguments
 - `(pt1,pt2)`, 42
- `\tkzDefGoldenRatio(pt1,pt2)`, 42
- `\tkzDefGoldenRectangle`, 93
- `\tkzDefGoldenRectangle`: arguments
 - `(pt1,pt2)`, 93
- `\tkzDefGoldenRectangle(point,point)`, 93
- `\tkzDefGoldRectangle`, 93
- `\tkzDefHarmonic`, 46
- `\tkzDefHarmonic`: options
 - `both`, 46
 - `ext`, 46
 - `int`, 46
- `\tkzDefHarmonic[options](pt1,pt2,pt3) or (pt1,pt2,k)`, 46
- `\tkzDefIntSimilitudeCenter`, 43
- `\tkzDefLine`, 72
- `\tkzDefLine`: arguments
 - `(pt1,pt2,pt3)`, 72
 - `(pt1,pt2)`, 72
 - `(pt1)`, 72
- `\tkzDefLine`: options
 - `K`, 73
 - `altitude`, 73

- bisector out, 73
- bisector, 73
- euler, 73
- mediator, 73
- normed, 73
- orthogonal=through..., 73
- parallel=through..., 73
- perpendicular=through..., 73
- symmedian, 73
- tangent at, 73
- tangent from, 73
- `\tkzDefLine[(local options)]((pt1,pt2)) or ((pt1,pt2,pt3))`, 72
- `\tkzDefMidArc`, 47
- `\tkzDefMidArc: arguments`
 - pt1,pt2,pt3*, 47
- `\tkzDefMidArc((pt1,pt2,pt3))`, 47
- `\tkzDefMidPoint`, 21, 41
- `\tkzDefMidPoint: arguments`
 - (pt1,pt2)*, 41
- `\tkzDefMidPoint((pt1,pt2))`, 41
- `\tkzDefParallelogram`, 93
- `\tkzDefParallelogram: arguments`
 - (pt1,pt2,pt3)*, 93
- `\tkzDefParallelogram((pt1,pt2,pt3))`, 93
- `\tkzDefPoint`, 34, 35, 41, 106, 117
- `\tkzDefPoint: arguments`
 - ($\alpha:d$)*, 35
 - (x,y)*, 35
 - {ref}*, 35
- `\tkzDefPoint: options`
 - label*, 35
 - shift*, 35
- `\tkzDefPointBy[rotation = ...]`, 117
- `\tkzDefPointBy`, 58
- `\tkzDefPointBy: arguments`
 - pt*, 58
- `\tkzDefPointBy: options`
 - homothety*, 58
 - inversion negative*, 58
 - inversion*, 58
 - projection* , 58
 - reflection*, 58
 - rotation in rad*, 58
 - rotation with nodes*, 58
 - rotation* , 58
 - symmetry* , 58
 - translation*, 58
- `\tkzDefPointBy[(local options)]((pt))`, 58
- `\tkzDefPointOnCircle`, 16, 50, 51
- `\tkzDefPointOnCircle: options`
 - R in rad*, 50
 - R*, 50
 - through in rad*, 50
 - through*, 50
- `\tkzDefPointOnCircle[(local options)]`, 50
- `\tkzDefPointOnLine`, 49
- `\tkzDefPointOnLine: arguments`
 - pt1,pt2*, 49

`\tkzDefPointOnLine`: options
 pos=nb, 49
`\tkzDefPointOnLine`[(local options)]((A,B)), 49
`\tkzDefPoints`{@/@/0,2/2/A}, 38
`\tkzDefPoints`, 34, 38
`\tkzDefPoints`: arguments
 $x_i/y_i/r_i$, 38
`\tkzDefPoints`: options
 shift, 38
`\tkzDefPointsBy`, 58, 66
`\tkzDefPointsBy`: arguments
 ((list of points)){(list of pts)}, 66
`\tkzDefPointsBy`: options
 homothety = center #1 ratio #2, 66
 inversion = center #1 through #2, 66
 inversion negative = center #1 through #2, 66
 projection = onto #1--#2, 66
 reflection = over #1--#2, 66
 rotation = center #1 angle #2, 66
 rotation in rad = center #1 angle #2, 66
 rotation with nodes = center #1 from #2 to #3, 66
 symmetry = center #1, 66
 translation = from #1 to #2, 66
`\tkzDefPointsBy`[(local options)]((list of points)){(list of points)}, 66
`\tkzDefPoints`[(local options)]{($x_1/y_1/n_1, x_2/y_2/r_2, \dots$)}, 38
`\tkzDefPointWith`, 67
`\tkzDefPointWith`: arguments
 (pt1,pt2), 67
`\tkzDefPointWith`: options
 K, 67
 colinear normed= at #1, 67
 colinear= at #1, 67
 linear normed, 67
 linear, 67
 orthogonal normed, 67
 orthogonal, 67
`\tkzDefPointWith`((pt1,pt2)), 67
`\tkzDefPoint`[(local options)]((x,y)){(ref)} or (($\alpha:d$)){(ref)}, 35
`\tkzDefProjExcenter`[name=J] (A,B,C) (a,b,c){Y,Z,X}, 100
`\tkzDefProjExcenter`, 100
`\tkzDefProjExcenter`: arguments
 (pt1= α_1 ,pt2= α_2 ,...), 100
`\tkzDefProjExcenter`: options
 name, 100
`\tkzDefProjExcenter`[(local options)]((A,B,C))((a,b,c)){(X,Y,Z)}, 100
`\tkzDefRadicalAxis`, 184
`\tkzDefRadicalAxis`: arguments
 (pt1,pt2)(pt3,pt4), 184
`\tkzDefRadicalAxis`((pt1,pt2))((pt3,pt4)), 184
`\tkzDefRandPointOn`, 18, 121
`\tkzDefRandPointOn`: options
 circle =center pt1 radius dim, 121
 circle through=center pt1 through pt2, 121
 disk through=center pt1 through pt2, 121
 line=pt1--pt2, 121
 rectangle=pt1 and pt2, 121
 segment= pt1--pt2, 121
`\tkzDefRandPointOn`[(local options)], 121

```

\tkzDefRectangle, 92
\tkzDefRectangle: arguments
  ( $\langle pt1, pt2 \rangle$ ), 92
\tkzDefRectangle( $\langle pt1, pt2 \rangle$ ), 92
\tkzDefRegPolygon, 94
\tkzDefRegPolygon: arguments
  ( $\langle pt1, pt2 \rangle$ ), 94
\tkzDefRegPolygon: options
  Options TikZ, 94
  center, 94
  name, 94
  sides, 94
  side, 94
\tkzDefRegPolygon[ $\langle local options \rangle$ ]( $\langle pt1, pt2 \rangle$ ), 94
\tkzDefShiftPoint, 36, 37
\tkzDefShiftPoint: arguments
  ( $\alpha:d$ ), 37
  ( $x,y$ ), 37
  {ref}, 37
\tkzDefShiftPoint: options
  [pt], 37
\tkzDefShiftPoint[ $\langle Point \rangle$ ]( $\langle x,y \rangle$ ){ref} or ( $\langle \alpha:d \rangle$ ){ref}, 37
\tkzDefSimilitudeCenter, 43
\tkzDefSimilitudeCenter: arguments
  ( $\langle pt1, pt2 \rangle$ )( $\langle pt3, pt4 \rangle$ ), 43
\tkzDefSimilitudeCenter: options
  ext, 43
  int, 43
\tkzDefSimilitudeCenter[ $\langle options \rangle$ ]( $\langle O,A \rangle$ )( $\langle O',B \rangle$ ), 43
\tkzDefSpcTriangle[medial,name=M_](A,B,C){A,B,C}, 83
\tkzDefSpcTriangle[medial,name=M](A,B,C){_A,_B,_C}, 83
\tkzDefSpcTriangle[medial](A,B,C){a,b,c}, 83
\tkzDefSpcTriangle, 83
\tkzDefSpcTriangle: options
  centroid or medial, 83
  euler, 83
  ex or excentral, 83
  extouch, 83
  feuerbach, 83
  in or incentral, 83
  intouch or contact, 83
  name, 83
  orthic, 83
  symmedial, 83
  tangential, 83
  , 83
\tkzDefSpcTriangle[ $\langle local options \rangle$ ]( $\langle p1,p2,p3 \rangle$ ){ $\langle r1,r2,r3 \rangle$ }, 83
\tkzDefSquare, 91, 92
\tkzDefSquare: arguments
  ( $\langle pt1, pt2 \rangle$ ), 91
\tkzDefSquare( $\langle pt1, pt2 \rangle$ ), 91
\tkzDefTriangle, 18, 78, 79
\tkzDefTriangle: options
  cheops, 79
  egyptian, 79
  equilateral, 79
  euclid, 79
  golden, 79

```

- gold, 79
- half, 79
- isosceles right, 79
- pythagoras, 79
- pythagore, 79
- school, 79
- sublime, 79
- swap, 79
- two angles= #1 and #2, 79
- `\tkzDefTriangleCenter[ortho](B,C,A)`, 52
- `\tkzDefTriangleCenter`, 52
- `\tkzDefTriangleCenter`: arguments
 - (pt1,pt2,pt3), 52
- `\tkzDefTriangleCenter`: options
 - centroid, 52
 - circum, 52
 - euler, 52
 - ex, 52
 - feuerbach, 52
 - gergonne, 52
 - grebe, 52
 - in, 52
 - lemoine, 52
 - median, 52
 - mittenpunkt, 52
 - nagel, 52
 - orthic, 52
 - ortho, 52
 - spieker, 52
 - symmedian, 52
- `\tkzDefTriangleCenter[⟨local options⟩](⟨A,B,C⟩)`, 52
- `\tkzDefTriangle[⟨local options⟩](⟨A,B⟩)`, 79
- `\tkzDotProduct`, 182
- `\tkzDotProduct`: arguments
 - (pt1,pt2,pt3), 182
- `\tkzDotProduct(⟨pt1,pt2,pt3⟩)`, 182
- `\tkzDrawArc[angles](O,A)(90,90)`, 136
- `\tkzDrawArc[delta=10](O,A)(B)`, 136
- `\tkzDrawArc[R with nodes](O,2)(A,B)`, 136
- `\tkzDrawArc[R](O,2)(30,90)`, 136
- `\tkzDrawArc[rotate,color=red](O,A)(90)`, 136
- `\tkzDrawArc`, 117, 136, 245
- `\tkzDrawArc`: options
 - R with nodes, 136
 - R, 136
 - angles, 136
 - delta, 136
 - reverse, 136
 - rotate, 136
 - towards, 136
- `\tkzDrawArc[⟨local options⟩](⟨O,...⟩)(⟨...⟩)`, 136
- `\tkzDrawCircle(s)`, 245
- `\tkzDrawCircle[R](O,3)`, 245
- `\tkzDrawCircle[R](O,3cm)`, 245
- `\tkzDrawCircle`, 96, 131, 141
- `\tkzDrawCircle`: arguments
 - (⟨pt1,pt2⟩), 131
- `\tkzDrawCircles`, 132

- `\tkzDrawCircles`: arguments
 - `(\langle pt1,pt2 pt3,pt4 \dots \rangle)`, 132
- `\tkzDrawCircles`: options
 - `through`, 132
- `\tkzDrawCircles[\langle local options \rangle](\langle A,B C,D \dots \rangle)`, 132
- `\tkzDrawCircle[\langle local options \rangle](\langle A,B \rangle)`, 131
- `\tkzDrawLine`, 125
- `\tkzDrawLine`: options
 - TikZ options, 125
 - `...`, 125
 - `add`, 125
- `\tkzDrawLines`, 125
- `\tkzDrawLines[\langle local options \rangle](\langle pt1,pt2 pt3,pt4 \dots \rangle)`, 125
- `\tkzDrawLine[\langle local options \rangle](\langle pt1,pt2 \rangle)` , 125
- `\tkzDrawPoint(A,B)`, 245
- `\tkzDrawPoint`, 123
- `\tkzDrawPoint`: arguments
 - name of point, 123
- `\tkzDrawPoint`: options
 - TikZ options, 123
 - `color`, 123
 - `shape`, 123
 - `size`, 123
- `\tkzDrawPoints(A,B)`, 245
- `\tkzDrawPoints(A,B,C)`, 124
- `\tkzDrawPoints`, 123, 124
- `\tkzDrawPoints`: arguments
 - points list, 124
- `\tkzDrawPoints`: options
 - `color`, 124
 - `shape`, 124
 - `size`, 124
- `\tkzDrawPoints[\langle local options \rangle](\langle liste \rangle)`, 124
- `\tkzDrawPoint[\langle local options \rangle](\langle name \rangle)`, 123
- `\tkzDrawPolygon`, 129
- `\tkzDrawPolygon`: arguments
 - `(\langle pt1,pt2,pt3,\dots \rangle)`, 129
- `\tkzDrawPolygon`: options
 - Options TikZ, 129
- `\tkzDrawPolygons`, 18
- `\tkzDrawPolygon[\langle local options \rangle](\langle points list \rangle)`, 129
- `\tkzDrawPolySeg`, 130
- `\tkzDrawPolySeg`: arguments
 - `(\langle pt1,pt2,pt3,\dots \rangle)`, 130
- `\tkzDrawPolySeg`: options
 - Options TikZ, 130
- `\tkzDrawPolySeg[\langle local options \rangle](\langle points list \rangle)`, 130
- `\tkzDrawSector(O,A)(B)`, 139
- `\tkzDrawSector[R with nodes](O,2)(A,B)`, 139
- `\tkzDrawSector[R,color=teal](O,2)(30,90)`, 139
- `\tkzDrawSector[rotate,color=red](O,A)(90)`, 139
- `\tkzDrawSector`, 139–141
- `\tkzDrawSector`: options
 - R with nodes, 139
 - R, 139
 - `rotate`, 139
 - `towards`, 139
- `\tkzDrawSector[\langle local options \rangle](\langle O,\dots \rangle)(\langle \dots \rangle)`, 139

- `\tkzDrawSegment(s)`, 245
- `\tkzDrawSegment`, 17, 125, 126
- `\tkzDrawSegment: arguments`
 - `(pt1,pt2)`, 126
- `\tkzDrawSegment: options`
 - TikZ options, 126
 - ..., 126
 - dim, 126
- `\tkzDrawSegments`, 128
- `\tkzDrawSegments[⟨local options⟩](⟨pt1,pt2 pt3,pt4 ...⟩)`, 128
- `\tkzDrawSegment[⟨local options⟩](⟨pt1,pt2⟩)`, 126
- `\tkzDrawSemiCircle`, 135
- `\tkzDrawSemiCircle: arguments`
 - `(⟨pt1,pt2⟩)`, 135
- `\tkzDrawSemiCircles`, 18, 135, 136
- `\tkzDrawSemiCircles: arguments`
 - `(⟨pt1,pt2 pt3,pt4 ...⟩)`, 135
- `\tkzDrawSemiCircles[⟨local options⟩](⟨A,B C,D ...⟩)`, 135
- `\tkzDrawSemiCircle[⟨local options⟩](⟨O,A⟩)`, 135
- `\tkzDrawTriangles`, 18
- `\tkzDuplicateLen`, 178
- `\tkzDuplicateLength`, 178
- `\tkzDuplicateSegment`, 178, 179
- `\tkzDuplicateSegment: arguments`
 - `(pt1,pt2)(pt3,pt4){pt5}`, 178
- `\tkzDuplicateSegment(⟨pt1,pt2⟩)(⟨pt3,pt4⟩){⟨pt5⟩}`, 178
- `\tkzFillAngle`, 145, 146, 201
- `\tkzFillAngle: options`
 - size, 146
- `\tkzFillAngles`, 146
- `\tkzFillAngles[⟨local options⟩](⟨A,O,B⟩)(⟨A',O',B'⟩)etc.`, 146
- `\tkzFillAngle[⟨local options⟩](⟨A,O,B⟩)`, 146
- `\tkzFillCircle`, 96, 141
- `\tkzFillCircle: options`
 - R, 141
 - radius, 141
- `\tkzFillCircle[⟨local options⟩](⟨A,B⟩)`, 141
- `\tkzFillPolygon`, 144
- `\tkzFillPolygon: arguments`
 - `(⟨pt1,pt2,...⟩)`, 144
- `\tkzFillPolygon[⟨local options⟩](⟨points list⟩)`, 144
- `\tkzFillSector(O,A)(B)`, 145
- `\tkzFillSector[R with nodes](O,2)(A,B)`, 145
- `\tkzFillSector[R,color=blue](O,2)(30,90)`, 145
- `\tkzFillSector[rotate,color=red](O,A)(90)`, 145
- `\tkzFillSector`, 140, 144, 145
- `\tkzFillSector: options`
 - R with nodes, 145
 - R, 145
 - rotate, 145
 - towards, 145
- `\tkzFillSector[⟨local options⟩](⟨O,...⟩)(⟨...⟩)`, 145
- `\tkzFindAngle`, 117
- `\tkzFindAngle: arguments`
 - `(pt1,pt2,pt3)`, 117
- `\tkzFindAngle(⟨pt1,pt2,pt3⟩)`, 117
- `\tkzFindSlopeAngle`, 119, 120
- `\tkzFindSlopeAngle: arguments`

(pt1,pt2), 119
`\tkzFindSlopeAngle($\langle A,B \rangle$)`, 119
`\tkzGetAngle`, 117–119
`\tkzGetAngle: arguments`
 name of macro, 117
`\tkzGetAngle(\langle name of macro \rangle)`, 117
`\tkzGetFirstPoint{A}`, 245
`\tkzGetFirstPoint{Jb}`, 99
`\tkzGetFirstPoint{M}` , 40
`\tkzGetFirstPoint`, 40, 91
`\tkzGetFirstPoint: arguments`
 ref1, 40
`\tkzGetFirstPoint{ \langle ref1 \rangle }`, 40
`\tkzGetLength{dAB}`, 179, 180
`\tkzGetLength`, 41, 96, 179, 180
`\tkzGetLength: arguments`
 name of a macro, 41
`\tkzGetLength{ \langle name of a macro \rangle }`, 41
`\tkzGetPoint(A)`, 245
`\tkzGetPoint{A}`, 245
`\tkzGetPoint{C}`, 67
`\tkzGetPoint{M}` , 40
`\tkzGetPoint{M}`, 58
`\tkzGetPoint`, 18, 21, 40–42, 52–54, 67, 72, 79, 93, 96, 97, 121
`\tkzGetPoint: arguments`
 ref, 40
`\tkzGetPointCoord`, 181
`\tkzGetPointCoord: arguments`
 (point){name of macro}, 181
`\tkzGetPointCoord(\langle A \rangle)`{name of macro}, 181
`\tkzGetPoints{A}{B}`, 245
`\tkzGetPoints{M,N}` , 40
`\tkzGetPoints{O'}{M'}`, 103
`\tkzGetPoints{z1}{z2}`, 102
`\tkzGetPoints`, 40, 72, 91–93, 96, 103
`\tkzGetPoints: arguments`
 {ref1,ref2}, 40
`\tkzGetPoints{ \langle ref1 \rangle }`{ \langle ref2 \rangle }, 40
`\tkzGetPoint{ \langle ref \rangle }`, 40
`\tkzGetRandPointOn`, 18, 120
`\tkzGetResult`, 182
`\tkzGetSecondPoint{A}`, 245
`\tkzGetSecondPoint{M}` , 41
`\tkzGetSecondPoint{Tb}`, 99
`\tkzGetSecondPoint`, 41, 91
`\tkzGetSecondPoint: arguments`
 ref2, 41
`\tkzGetSecondPoint{ \langle ref2 \rangle }`, 41
`\tkzGetVectxy`, 72
`\tkzGetVectxy: arguments`
 (point){name of macro}, 72
`\tkzGetVectxy(\langle A,B \rangle)`{ \langle text \rangle }, 72
`\tkzInit`, 17, 23, 28, 147, 148
`\tkzInit: options`
 xmax, 148
 xmin, 148
 xstep, 148
 ymax, 148

- ymin, 148
- ystep, 148
- \tkzInit[[\(local options\)](#)], 148
- \tkzInterCC, 40, 112
- \tkzInterCC: options
 - N, 112
 - R, 112
 - common=pt, 112
 - with nodes, 112
- \tkzInterCC[[\(options\)](#)]($\langle O,A \rangle$)($\langle O',A' \rangle$) or ($\langle O,r \rangle$)($\langle O',r' \rangle$) or ($\langle O,A,B \rangle$)($\langle O',C,D \rangle$), 112
- \tkzInterLC, 106
- \tkzInterLC: options
 - N, 106
 - R, 106
 - common=pt, 106
 - near, 106
 - with nodes, 106
- \tkzInterLC[[\(options\)](#)]($\langle A,B \rangle$)($\langle O,C \rangle$) or ($\langle O,r \rangle$) or ($\langle O,C,D \rangle$), 106
- \tkzInterLL, 106
- \tkzInterLL($\langle A,B \rangle$)($\langle C,D \rangle$), 106
- \tkzIsLinear, 186, 187
- \tkzIsLinear: arguments
 - (pt1,pt2,pt3), 186
- \tkzIsLinear([\(pt1,pt2,pt3\)](#)), 186
- \tkzIsOrtho, 186, 187
- \tkzIsOrtho: arguments
 - (pt1,pt2,pt3), 186
- \tkzIsOrtho([\(pt1,pt2,pt3\)](#)), 186
- \tkzLabelAngle, 168
- \tkzLabelAngle: options
 - pos, 169
- \tkzLabelAngles, 170
- \tkzLabelAngles[[\(local options\)](#)]($\langle A,O,B \rangle$)($\langle A',O',B' \rangle$)etc., 170
- \tkzLabelAngle[[\(local options\)](#)]($\langle A,O,B \rangle$), 168
- \tkzLabelArc(A,B){5}, 171
- \tkzLabelArc, 171
- \tkzLabelArc: arguments
 - (pt1,pt2,pt3), 171
 - label, 171
- \tkzLabelArc: options
 - pos, 171
- \tkzLabelArc[[\(local options\)](#)]([\(pt1,pt2,pt3\)](#)){[\(label\)](#)}, 171
- \tkzLabelCircle, 96, 170
- \tkzLabelCircle: options
 - tikz options, 170
- \tkzLabelCircle[[\(tikz options\)](#)]($\langle O,A \rangle$)($\langle angle \rangle$){[\(label\)](#)}, 170
- \tkzLabelLine(A,B), 168
- \tkzLabelLine, 17, 168
- \tkzLabelLine: arguments
 - label, 168
- \tkzLabelLine: options
 - pos, 168
- \tkzLabelLine[[\(local options\)](#)]([\(pt1,pt2\)](#)){[\(label\)](#)}, 168
- \tkzLabelPoint(A){ $\$A_1\$$ }, 165
- \tkzLabelPoint(A,B,C), 166
- \tkzLabelPoint, 165
- \tkzLabelPoint: arguments
 - point, 165

- \tkzLabelPoint: options
 - TikZ options, 165
- \tkzLabelPoints(A,B,C), 165
- \tkzLabelPoints, 165, 166
- \tkzLabelPoints: arguments
 - list of points, 165, 166
- \tkzLabelPoints[*(local options)*](*(A₁,A₂,...)*), 165, 166
- \tkzLabelPoint[*(local options)*](*(point)*){*(label)*}, 165
- \tkzLabelSegment(A,B){5}, 166
- \tkzLabelSegment, 166
- \tkzLabelSegment: arguments
 - (pt1,pt2), 166
 - label, 166
- \tkzLabelSegment: options
 - pos, 166
- \tkzLabelSegments, 168
- \tkzLabelSegments[*(local options)*](*(pt1,pt2 pt3,pt4 ...)*), 168
- \tkzLabelSegment[*(local options)*](*(pt1,pt2)*){*(label)*}, 166
- \tkzMarkAngle, 159, 160, 201, 245
- \tkzMarkAngle: options
 - arc, 160
 - mark, 160
 - mkcolor, 160
 - mkpos, 160
 - mksize, 160
 - size, 160
- \tkzMarkAngles, 160
- \tkzMarkAngles[*(local options)*](*(A,O,B)*)(*(A',O',B')*)etc., 160
- \tkzMarkAngle[*(local options)*](*(A,O,B)*), 160
- \tkzMarkArc, 159
- \tkzMarkArc: options
 - color, 159
 - mark, 159
 - pos, 159
 - size, 159
- \tkzMarkArc[*(local options)*](*(pt1,pt2,pt3)*), 159
- \tkzMarkRightAngle, 160
- \tkzMarkRightAngle: options
 - german, 160
 - size, 160
- \tkzMarkRightAngles, 162
- \tkzMarkRightAngles[*(local options)*](*(A,O,B)*)(*(A',O',B')*)etc., 162
- \tkzMarkRightAngle[*(local options)*](*(A,O,B)*), 160
- \tkzMarkSegment, 158
- \tkzMarkSegment: options
 - color, 158
 - mark, 158
 - pos, 158
 - size, 158
- \tkzMarkSegments, 158
- \tkzMarkSegments[*(local options)*](*(pt1,pt2 pt3,pt4 ...)*), 158
- \tkzMarkSegment[*(local options)*](*(pt1,pt2)*), 158
- \tkzPermute, 90
- \tkzPermute: arguments
 - (pt1,pt2,pt3), 90
- \tkzPermute(*(pt1,pt2,pt3)*), 90
- \tkzPicAngle, 162
- \tkzPicAngle: options

- tikz option, 162
- \tkzPicAngle[*(tikz options)*](*(A,0,B)*), 162
- \tkzPicRightAngle, 162
- \tkzPicRightAngle: options
 - tikz option, 162
- \tkzPicRightAngle[*(tikz options)*](*(A,0,B)*), 162
- \tkzPowerCircle, 184
- \tkzPowerCircle: arguments
 - (pt1)(pt2,pt3), 184
- \tkzPowerCircle(*(pt1)*)(*(pt2,pt3)*), 184
- \tkzProtractor, 16, 177
- \tkzProtractor: options
 - lw, 177
 - return, 177
 - scale, 177
- \tkzProtractor[*(local options)*](*(O,A)*), 177
- \tkzpttocm, 180
- \tkzpttocm: arguments
 - (number){name of macro}, 180
- \tkzpttocm(*(number)*){*(name of macro)*}, 180
- \tkzSaveBB, 17
- \tkzSetUpArc, 18, 193
- \tkzSetUpArc: options
 - color, 193
 - line width, 193
 - style, 193
- \tkzSetUpArc[*(local options)*], 193
- \tkzSetUpColors, 189
- \tkzSetUpCompass, 18, 194
- \tkzSetUpCompass: options
 - color, 194
 - delta, 194
 - line width, 194
 - style, 194
- \tkzSetUpCompass[*(local options)*], 194
- \tkzSetUpLabel, 18, 194, 195
- \tkzSetUpLine, 18, 124, 191
- \tkzSetUpLine: options
 - add, 191
 - color, 191
 - line width, 191
 - style, 191
- \tkzSetUpLine[*(local options)*], 191
- \tkzSetUpPoint, 18, 189–191
- \tkzSetUpPoint: options
 - color, 189
 - fill, 189
 - shape, 189
 - size, 189
- \tkzSetUpPoint[*(local options)*], 189
- \tkzSetUpStyle, 18, 195
- \tkzSetUpStyle[*(local options)*], 195
- \tkzShowBB, 149
- \tkzShowBB[*(local options)*], 149
- \tkzShowLine, 174, 175, 194
- \tkzShowLine: options
 - K, 174
 - bisector, 174

- gap, 174
- length, 174
- mediator, 174
- orthogonal, 174
- perpendicular, 174
- ratio, 174
- size, 174

`\tkzShowLine`[(local options)]($\langle pt1, pt2 \rangle$) or ($\langle pt1, pt2, pt3 \rangle$), 174

`\tkzShowTransformation`, 175, 176

`\tkzShowTransformation`: options

- K, 176
- gap, 176
- length, 176
- projection=onto $pt1--pt2$, 176
- ratio, 176
- reflection= over $pt1--pt2$, 176
- size, 176
- symmetry=center pt, 176
- translation=from $pt1$ to $pt2$, 176

`\tkzShowTransformation`[(local options)]($\langle pt1, pt2 \rangle$) or ($\langle pt1, pt2, pt3 \rangle$), 175

`\tkzSwapPoints`, 182

`\tkzSwapPoints`: arguments

- ($pt1, pt2$), 182

`\tkzSwapPoints`($\langle pt1, pt2 \rangle$), 182

`\tkzTestInterCC`, 112

`\tkzTestInterCC`($\langle O, A \rangle$)($\langle O', B \rangle$), 112

`\tkzTestInterLC`, 106

`\tkzTestInterLC`($\langle O, A \rangle$)($\langle O', B \rangle$), 106

`\useasboundingbox`, 147

`\usetkzobj`{all}, 17

`\usetkztool`, 18

`\Vx`, 72

`\Vy`, 72

`\xstep`, 148

`\ystep`, 148